

LCD 5 LINE DIGITAL OPERATOR

USER'S MANUAL

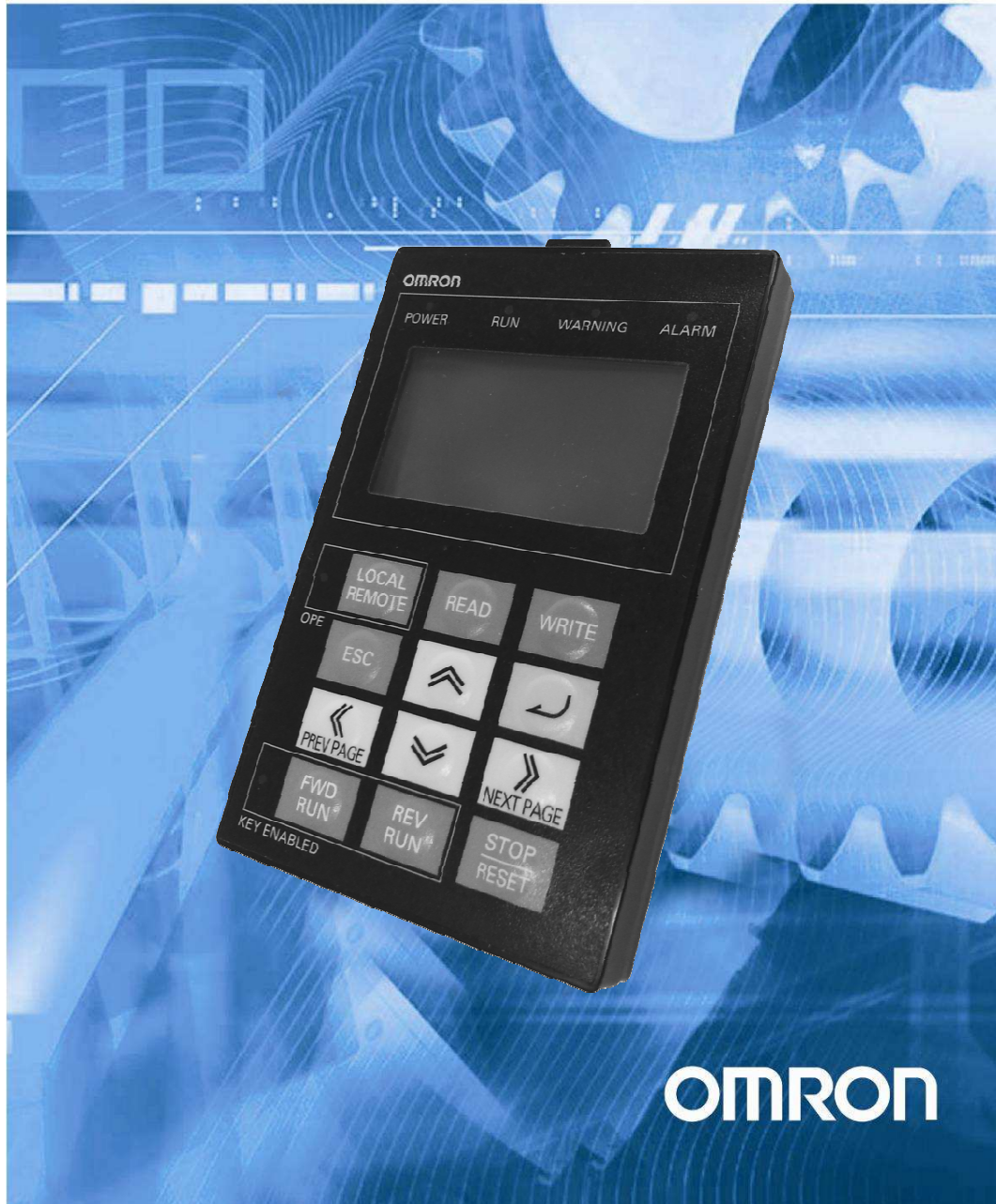

Table of Contents

1. Introduction	4
1.1 Main Features	4
1.2 Unpacking and Inspection.....	4
2. Name of parts and contents	5
2.1 Operation Key	6
2.2 LCD display.....	7
2.3 Connection, wiring, and attaching.....	8
3. Operation	9
3.1 Changing Display Modes	9
3.2 Option Mode.....	10
3.3 Details of Option mode.....	11
3.4 Monitor-A Display Mode.....	12
3.5 Monitor-B Display Mode.....	13
3.6 Function Mode	14
3.7 Trip Mode	15
4. Read/Write function and operation	16
4.1 R/W Storage Mode - Single READ function.....	16
4.2 R/W Storage Mode - Single WRITE function.....	17
4.3 R/W Storage Mode - Quad READ Function.....	18
4.4 R/W Storage Mode - Quad VERIFY Function.....	20
4.5 R/W Storage Mode - Quad WRITE function	21
4.6 Operation condition of Read and Write function	23
5. Inverter setting concerning LCD Operator	24
6. Error Message	25
7. Trouble shooting	26
8. Specification	27
9. Battery exchange	28

Thank you for purchasing LCD digital operator. This instruction manual is written about how to use LCD digital operator.

You could use this manual for inspection, maintenance, setting and use it with the main body of inverter. After reading this manual, keep it handy for future reference.

SAFETY

To get best performance with LCD digital operator, read this manual and all of the warning sign attached to the inverter carefully before installation and operation, and follow the instruction exactly.

A safety instruction (message) is given with a hazard alert symbol and a signal word; **WARNING** or **CAUTION**. Each signal word has the following meaning throughout this manual.



This symbol means hazardous high voltage. It used to call your attention to items or operations that could be dangerous to you and/or other persons operating this equipment. Read these messages and follow these instructions carefully.



This is the "Safety Alert Symbol". This symbol is used to call your attention to items or operations that could be dangerous to you and/or other persons operating this equipment. Read the messages and follow these instructions carefully.

WARNING



WARNING

Indicates a potentially hazardous situation which, if not avoided, can result in serious injury or death.

CAUTION



CAUTION

Indicates a potentially hazardous situation which, if not avoided, can result in minor to moderate injury, or serious damage of product.

The matters described under  may, if not avoided, lead to serious results depending on the situation. Important matters are described in **CAUTION** (as well as **WARNING**), so be sure to observe them.

NOTE

NOTE

It indicates an area or subject of special merit, emphasizing either the product's capabilities or common errors in operation or maintenance.



HAZARDOUS HIGH VOLTAGE

Motor control equipment and electronic controllers are connected to hazardous line voltages. When servicing drives and electronic controllers, there might be exposed components with cases or protrusions at or above line potential. Extreme care should be taken to protect against shock. Stand on an insulating pad and make it a habit to use only one hand when checking components. Always work with another person in case an emergency occurs. Disconnect power before checking controllers or performing maintenance. Be sure equipment is properly grounded. Wear safety glasses whenever working on electronic controllers or rotating electrical equipment.

1. Introduction

1.1 Main Features

LCD digital operator features state-of-the-art components and functions to provide user-friendly interface. LCD digital operator can connect to MX2, RX and LX inverters and has 5-line display that shows parameters by function code and by name. This allows you to operate the inverter remotely, via a cable.

It has the additional capability of reading up to 5 Parameter Sets or a Parameter Set + Drive Programming application from the inverter and store into the LCD digital operator memory. It is possible after to copy them to another inverter.

1.2 Unpacking and Inspection

Please take a few moments to unpack your new LCD digital operator and perform these steps:

- (1) Look for any damage that may have happened during shipping.
- (2) Verify the contents of the box including LCD digital operator (with built-in battery)
- (3) Inspect the name plate and make sure it matches the product part number you ordered.



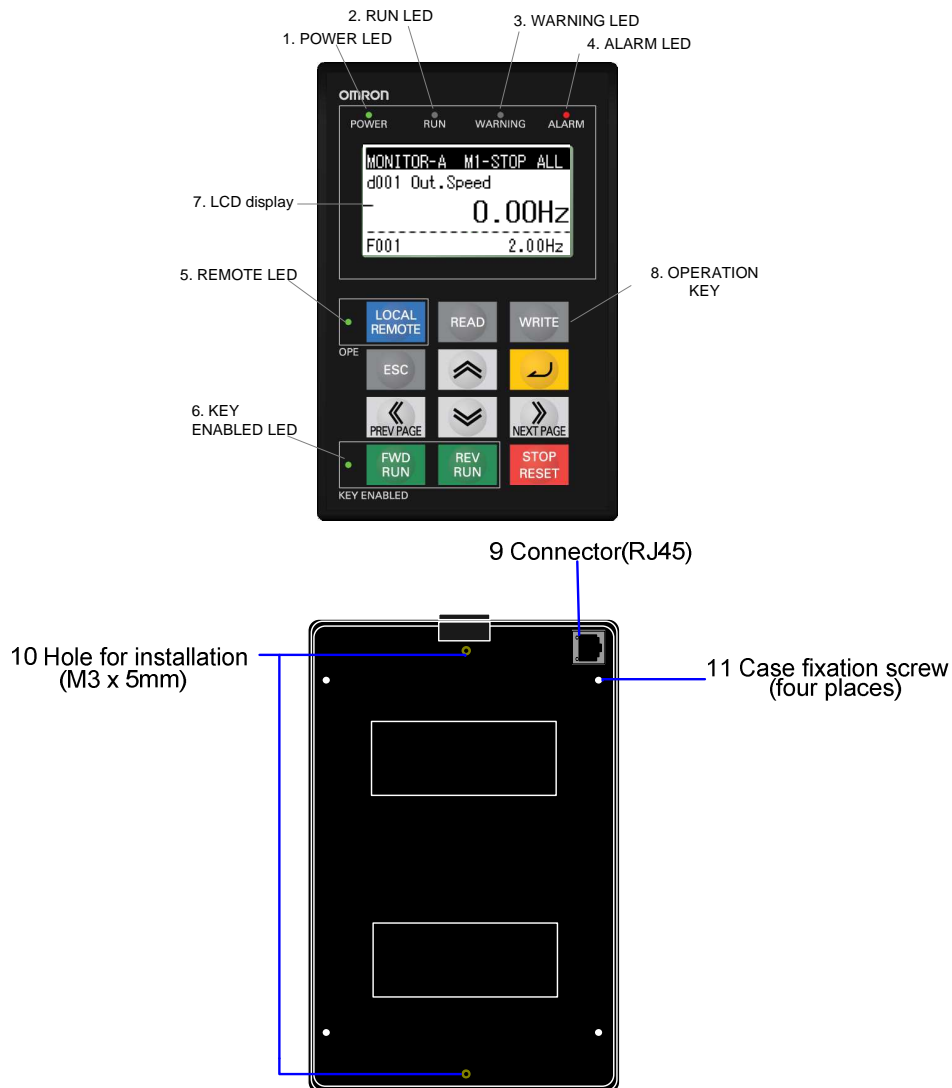









2. Name of parts and contents



NO.	Name of parts	Color	Contents
1	Power Led	Green	Light on when power is supplied to the LCD digital operator.
2	Run Led	Green	Light on when the Inverter is running.
3	Warning Led	Red	Light on when set value is incorrect.
4	Alarm Led	Red	Light on when the inverter trips.
5	Remote Led	Green	Light on when the REMOTE key makes the compulsion operation function effective. It doesn't light when the compulsion operation function is effective by input terminal OPE. (Press the key more than 2 seconds)
6	Key Enabled Led	Green	Light on only when operation command is set in LCD digital operator.
7	LCD Display		Please refer to point 2.2 for details.
8	Operation Key		Please refer to point 3 for details.
9	Connector		It can be connected to the main body of the inverter via a cable (optional)
10	Hole for installation		It is the hole for installation on the control panel. Please fix from the backside with the M3 screw.
11	Case fixation screw		Please unscrew these four screws and detach the case when exchanging the battery for clock IC.

2.1. Operation Key



NO.	Key image	Key Name	Function
1		REMOTE	It changes from Local to Remote mode. Press the key during 2 seconds to change from Local to Remote or Remote to Local. When it is in Local the OPE led will be ON. Use Local to control the motor with LCD digital operator keys (Run Fwd, Run Rev and Stop/Reset).
2		READ	It transfers inverter parameters to the LCD digital operator's memory. (Refer to chapter 4 for more details.)
3		WRITE	It copies one Parameter Set or a Parameter Set + EzSQ (Drive Programming) saved in LCD digital operator to the inverter. (Refer to chapter 4 for more details.)
4		ESC	It returns to the above layer.
5		SET	It jumps to the below layer or stores the change introduced on the edit layer (after that it jumps to the above layer).
6		UP	It is used to move up the cursor, it increases a function code in 1 or increases a parameter value.
7		DOWN	It is used to move down the cursor, it decreases a function code in 1 or it decreases a value.
8		LEFT CURSOR	It is used to move the cursor to the left or it moves to previous mode when the display is at navigation level.
9		RIGHT CURSOR	It is used to move the cursor to the right, or it moves to the next mode when the display is at navigation level.
10		FWD RUN	It is used to run forward the motor only when the operation command (A002) is set in Digital operator. (Check KEY ENABLED LED)
11		REV RUN	It is used to run reverse the motor only when the operation command (A002) is set in Digital operator (Check KEY ENABLED LED)
12		STOP/RESET	It is used to stop the motor or reset an alarm. It is also possible to invalidate the STOP key by B087 parameter. Besides it does not response when LCD digital operator is reading or writing the parameters from/to the inverter.

2.2. LCD Display

Backlight

There are two backlight colors in the LCD display, white and orange. They reflect the state of the inverter as follows:

Backlight Color	Contents
White	Normal (It is not related to inverter driving/stop)
Orange	Warning (Parameter mismatch)
White ↔ Orange (Alternate blinking for one second)	Trip (The same as ALARM LED)

Details of LCD Display

The first line of LCD monitor always displays the Display Mode, the Motor Selected, the Inverter RUN Status and the Display Selection.

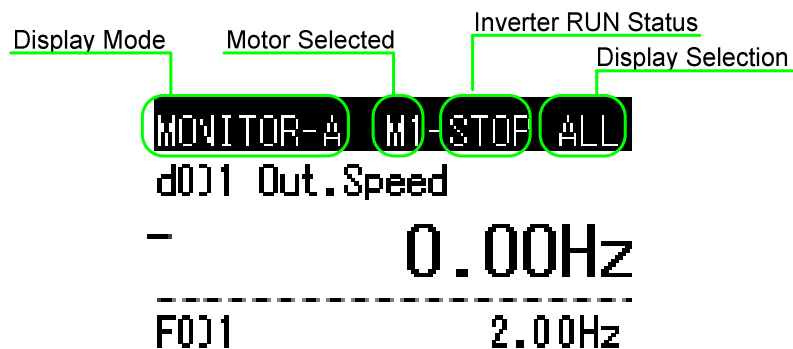

Item	Content of Display	Content
Display Mode	MONITOR-A	Monitor-A mode
	MONITOR-B	Monitor-B mode
	FUNCTION	Function mode
	TRIP	Trip (error) mode
	WARNING	Warning mode (Alarm)
	OPTION	LCD Configuration Mode
Motor selected	M1	Motor 1 (SET multifunction = OFF)
	M2	Motor 2 (SET multifunction = ON)
Inverter RUN Status	STOP	Stopped
	FWD	Forward running
	REV	Reverse running
Display Selection (b037)	ALL	Display all
	UTL	Function individual display
	USR	User setting display
	CMP	Data compare display
	BAS	Basic display

2.3 Connection, wiring, and attaching

Please process the control panel as shown, and fix from the other side with M3 screw (5mm) when you install the operator on the control panel. Recommended torque is [0.9, 1.0] Nm.

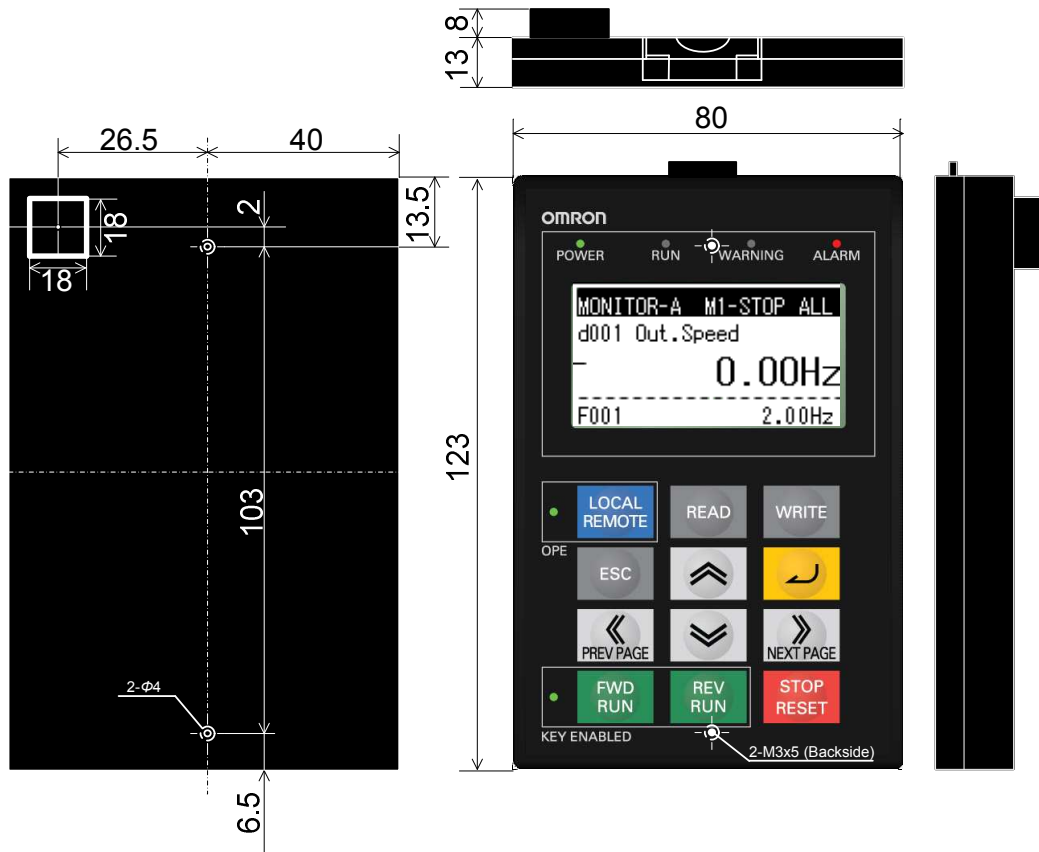

Recommended cable









Model	Content
ICS-1	1m cable
ICS-3	3m cable
ICS-5	5m cable

Make sure to use a straight cable within 5m in length and 10BASE-T category 5 (CAT5) of UTP or STP when the cable is prepared by the customer.

NOTE: UTP (Unshielded twist pair cable), STP (Shielded twist pair cable)

3. Operation



3.1 Changing Display Modes

LCD digital operator has four display modes which can be changed from one to another by pressing the  or  key at Navigation level. Moreover, there are 3 other modes called Read mode, Write mode and Option mode. In any display mode, it moves to Read mode or Write mode via  key or  key, and moves to Option mode after pressing ,  and  at the same time. It returns to display modes via  key.

Each mode has its own layers, where contents and parameter settings cannot be changed at Navigation level.

When pressing  key at Navigation level, a cursor will appear on below layer.

• LCD Navigation levels

To move among the different Navigation levels press keys  or . The outline of each mode is shown as below.

Monitor Mode A

The “d” group inverter parameters and “F~U” group inverter parameter are displayed on the same screen in this mode. The content of “d” group parameter is displayed with big font characters. The function code such as “F001” and contents of “F~U” parameters are displayed, without the function name.

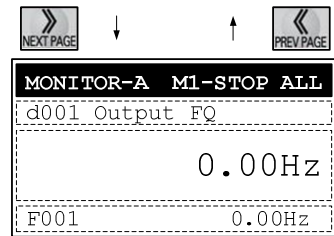

Monitor Mode B (Monitor x 4)

In this mode, four “d” group inverter parameters can be displayed at the same screen. The function codes of these parameters are not displayed.

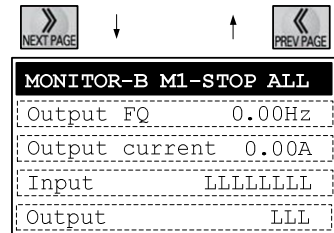

Function Mode (setting)

In this mode, “F~U” group parameters can be displayed and set. Function code, function name, parameter content and parameter range are shown.

NOTE: “d” group inverter parameter cannot be set and displayed in this mode.

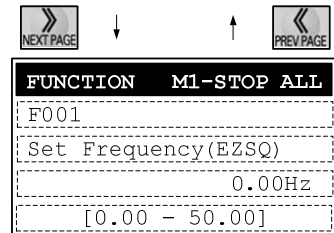





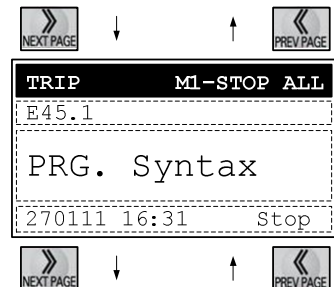

Trip Mode

Trip information and warning information are displayed in this mode. With inverter trip or a warning happens, the trip screen will be displayed from any display modes.





In Option Mode, Read Mode and Write Mode, the LED or WARNING LED will light up.

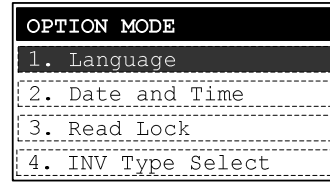

3.2 Option Mode

1- Please press  and  and  key at the same time to enter into the OPTION MODE. The cursor will appear in the first row of the Option Mode menu. Use  or  key to move between the option Mode menu. To return to the navigation layer, press the  key.





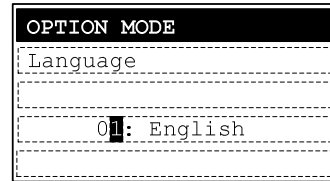

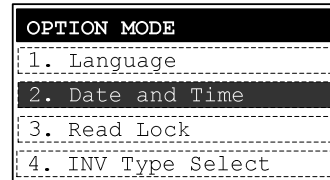

2- Select the Language option and press the  key. The cursor will appear in the Language option value. Use the  or  key to select the value to set. Press the  key to store the new value. Press the  key to cancel the new value.



3- The cursor will appear in the second row (2. Date and Time).



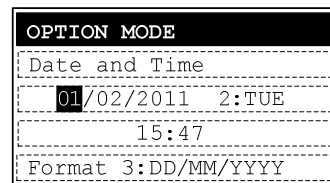

4- Pressing the  key, it enters to the Date and Time layer. Use the  or  key for moving between the Day, Month, Year, Hour, etc... data. When the cursor is over the selected data, pressing  or  key to change the value. The change will be stored after pressing the  key.

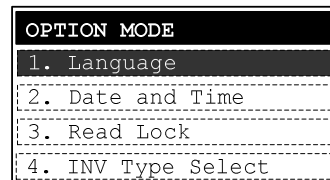

The settings available in this mode are:

1. Language
2. Date and Time
3. Read Lock
4. INV Type Select
5. R/W Storage Mode
6. Backlight Auto-off
7. Backlight Flicker
8. Operator Reset
9. Check Mode





Use  or  for moving between the Option Mode Menu.

3.3 Details of Option mode

Item	Content	Setting range	Default
Language	Setting language	01: English 02: Deutsch 03: Français 04: Español 05: Italiano 06: Português 07: 日本語 (Japanese) 08: 中文 (Chinese) 09: Türkçe 10: Русский	01
Date and Time	Setting Date and Time for the LCD digital operator	Date: 2000/1/1~2099/12/31 Time: 00:00~23:59 Format 1~3	2009/01/01 00:00 1
Read Lock	Set "Read lock" enable to disable, in order to protect the parameter saved in LCD digital operator from being overwritten.	01: Enable 02: Disable	02
INV Type Select	Please select the correct INV type using LCD digital operator, otherwise, "COM ERROR" will be displayed automatically.	01: Type 1 (MX2, LX) 02: Type 2 (RX)	01
R/W Storage Mode	Sets the number of parameter sets for READ/WRITE mode. (Refer to chapter 4 for more details.)	01: Single 02: Quad	02
Backlight Auto-Off	When LCD digital operator remains without key operations for 1 minute, LCD backlight will be turned off. When a key is pressed it will be turned on. The Backlight Auto-Off function does not work when trip happened.	01: Off 02: 1 minute	01
Backlight Flicker	The Orange backlight will be enabled or disabled..	01: Enable 02: Disable	01
Operator Reset	Use this function to return to default settings of LCD digital operator. The next items will be reset: 1) Language: English 2) Date and time: 2009/01/01 THU 00:00 3) Time format: 01:YY/MM/DD 4) Read lock: Disable 5) R/W Storage Mode: Quad 6) Backlight Auto-Off: Off 7) Backlight Flicker: Enable After this, date and time setting is required.	01: YES 02: NO	02
Check Mode	Check if LED and key etc. are normal or not.	Key&Led Check, Lcd Check, EEPROM Check, RTC Check, Serial Loopback, Debug Mode, Firmware Version.	-

NOTE: Please do not execute the EEPROM check. Otherwise, the data (parameters/EzSQ program) saved in LCD digital operator will be erased.



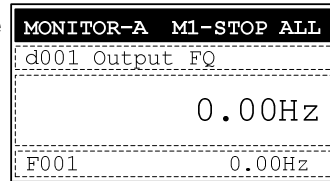

3.4 Monitor-A Display Mode

1- Please select monitor mode A by using the  or  key at the navigation layer. The cursor will be displayed in the Monitor-A pressing the  key.

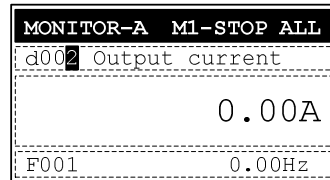





2- After that, use the  or  key to select the function code to be displayed into the Monitor-A.

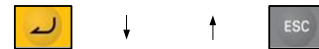
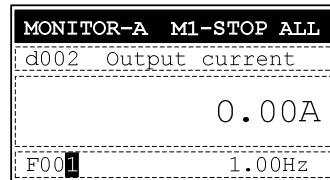



Use  or  key to move the cursor to the function code (F001 in this case) and use the  or  key to change the function code,



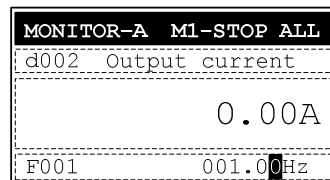



3- Use the  key to access to the function code value. With the  or  key the value can be changed. The changes will be stored after pressing the  key or cancelled pressing the  key.



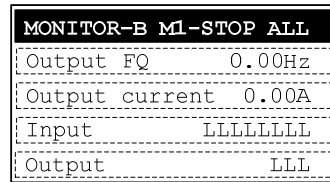



3.5 Monitor-B Display Mode

1- Please select the Display Mode Monitor-B using the  or  key at the navigation layer.

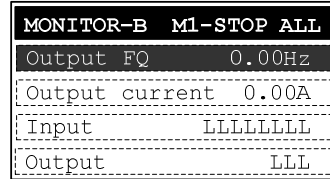

2- After pressing the  key the cursor will appear on the first row of the four “d” group inverter parameters. Use the  or  key to move between the four Monitor-B inverter parameters.



3- Pressing the  key the cursor will appear on the function code of the “d” inverter parameter selected. Use the  or  key to select other function code.



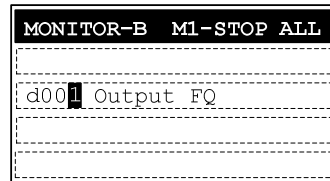

- Pressing the  key, the function code is selected, and then displayed on the Monitor-B display Mode.





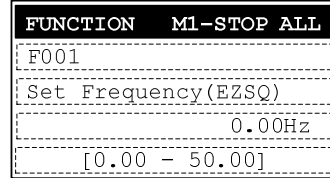

- Pressing the  key, the change will be cancelled..

3.6 Function Mode



1- Please select Function Mode by using the  or  key at the navigation level.



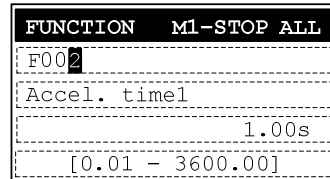

2- Pressing the  key the cursor will appear in the function code.

Then use the , ,  or  key to select the function that will be changed.





3- After that, pressing the  key the cursor will appear in the parameter value. Use the  or  key to select the value to be set.

· To store the parameter value, press the  key.

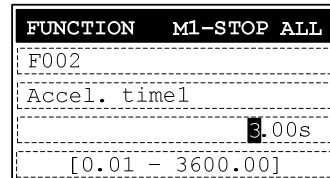

· Pressing the  key, changes will be cancelled.



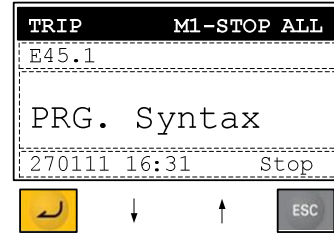

3.7 Trip Mode

1- Select the  or  key to select trip mode at the navigation layer.

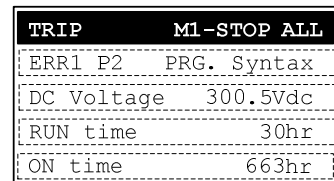
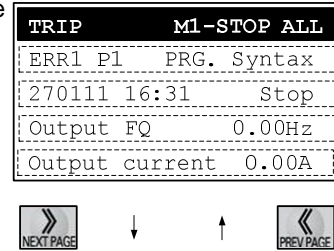

2- Pressing the  key, the past trip information (6 trip errors) and the warning information (1 time), that are recorded on the inverter, will be displayed. Trip information is composed in two pages. For change from page 1 (P1) to page 2 (P2), press the  or  key.



Pressing 6 times the  key, it will be displayed the Warning Mode.

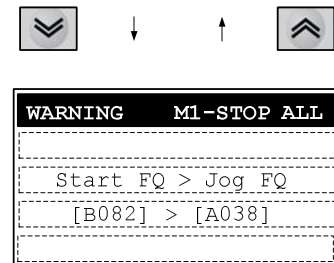

NOTE: When a trip happens, ALARM LED will be light on. Press the  key to reset the inverter.

4. Read/Write function and operation

LCD digital operator can read and save Inverter parameter settings, and copy them to another inverter. Specifically LCD digital operator can save four inverters' parameter sets or one inverter's parameter set and its EzSQ (Drive Programming) program. It can be selected via the R/W Storage Mode in the LCD configuration Option Mode.

Note: If Read operation cannot be executed, please check the Read Lock option in the LCD configuration Option Mode.

4.1 R/W Storage Mode - Single READ function

When the R/W Storage Mode is selected to "01:Single" (this is done in the LCD configuration : Option Mode), the function Read or Write is executed immediately after pressing **READ** or **WRITE** key.

After pressing the **READ** key in any display mode, except Write mode and Option mode, the inverter's parameter configuration are read and saved into LCD digital operator EzSQ (Drive Programming) program will be transferred to the LCD digital operator automatically after parameter reading is finished. If the inverter supports EzSQ (Drive Programming) function, it returns to the previous display after read function is completed.

When the inverter does NOT support EzSQ (Drive Programming) function

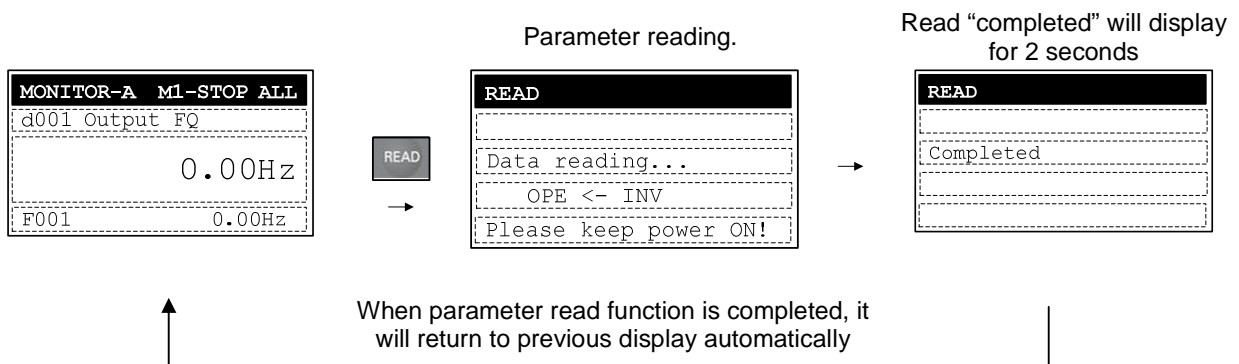

When the inverter supports EzSQ (Drive Programming) function

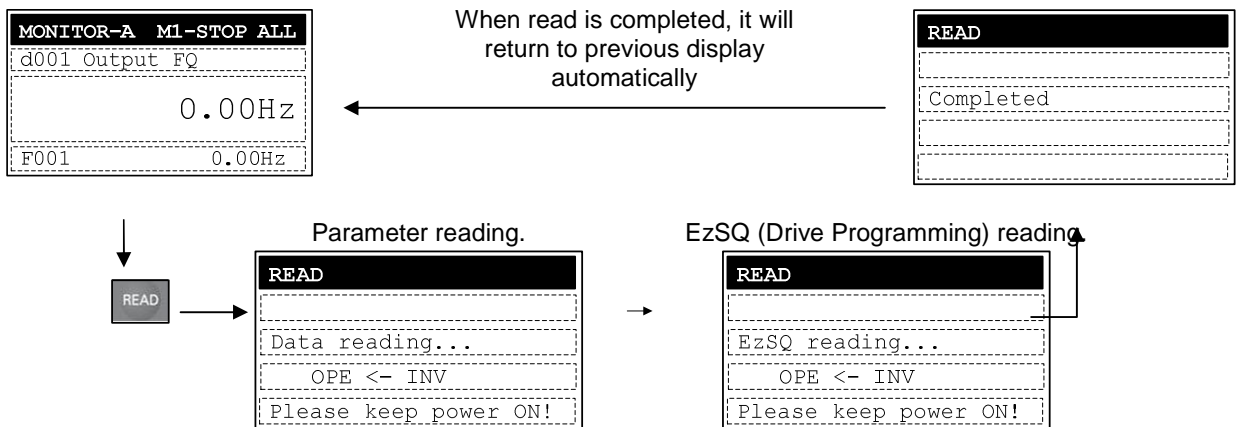

NOTE: All inverter parameters saved in LCD digital operator are overwritten after the **READ** key is pressed.

4.2 R/W Storage Mode - Single WRITE function

After pressing the **WRITE** key in any display mode except Read mode and Option mode, the parameter settings stored in LCD digital operator are transferred to the inverter. If the inverter supports EzSQ (Drive Programming), it will be transferred to the inverter automatically after the parameter copy is finished. It will return to the previous display after write function is completed.

When the inverter does NOT support EzSQ (Drive Programming) function

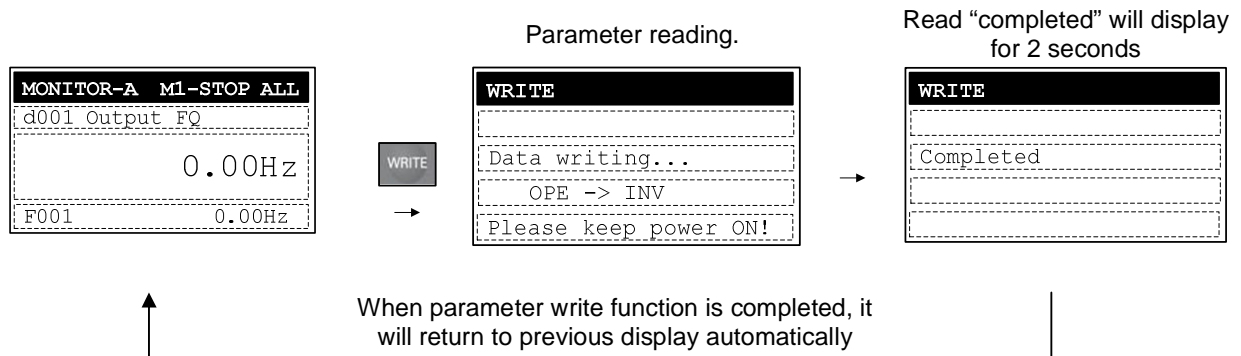

When the inverter supports EzSQ (Drive Programming) function

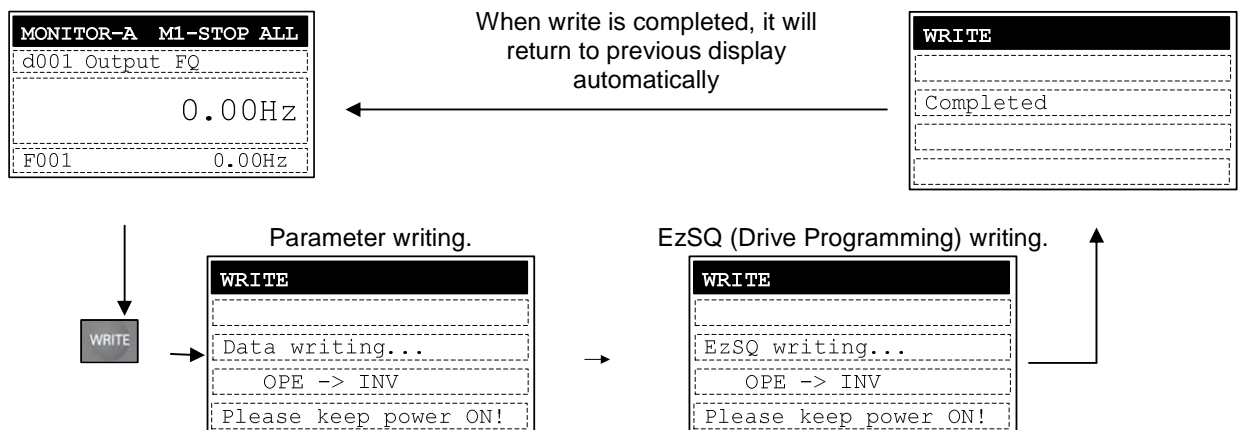

NOTE: Refer to chapter 4.6 for details.

4.3 R/W Storage Mode - Quad READ Function

When the R/W storage mode is selected to 02:Quad option, it will be possible to handle four sets of inverter parameters or read/write an EzSQ (Drive Programming) program independently. In this case, LCD digital operator can save four sets of inverter parameters, or one set of inverter parameters and one EzSQ (Drive Programming) program. Please note that one EzSQ (Drive Programming) program takes up three sets of inverter parameters, which are No.2, No.3 and No.4.

When the inverter does NOT support EzSQ (Drive Programming) function

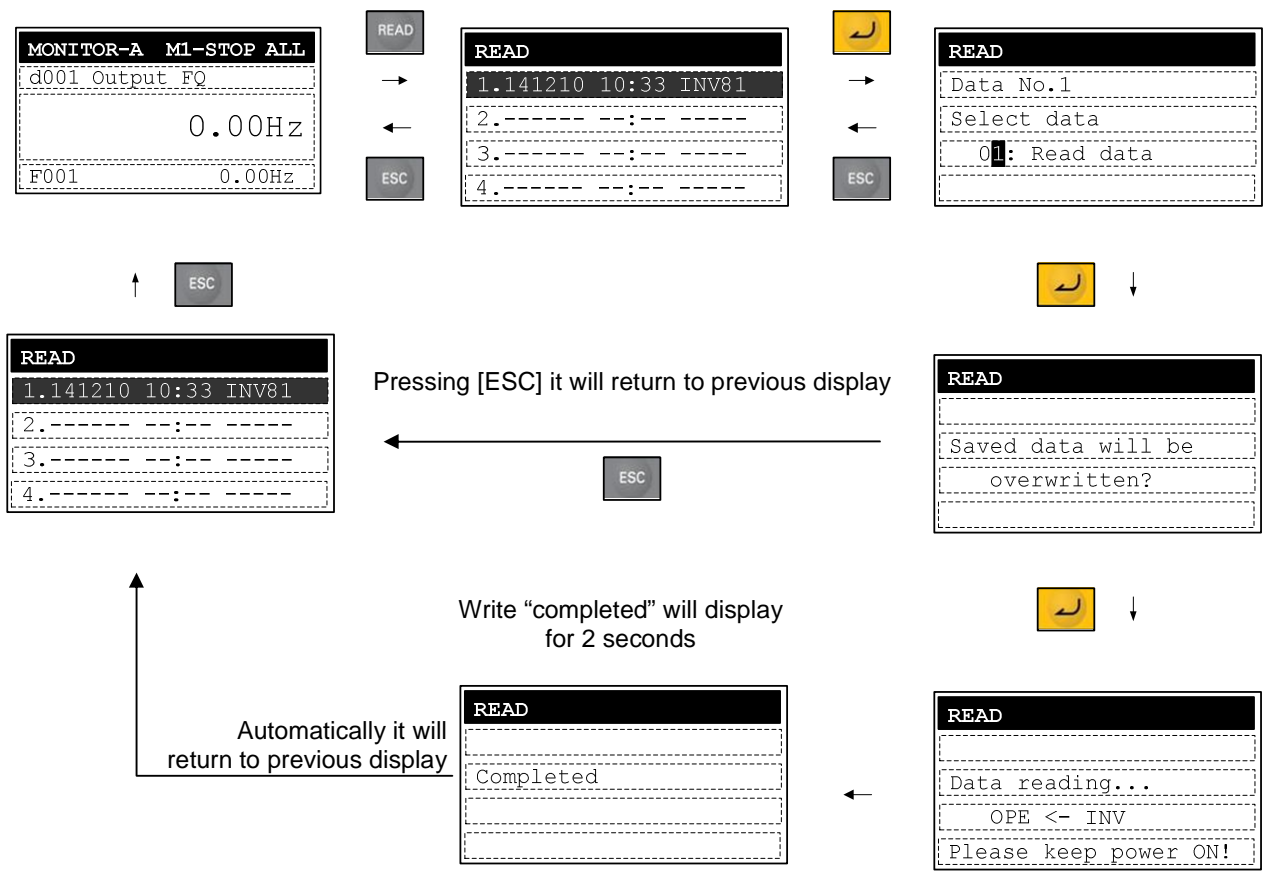

When the inverter supports EzSQ (Drive Programming) function

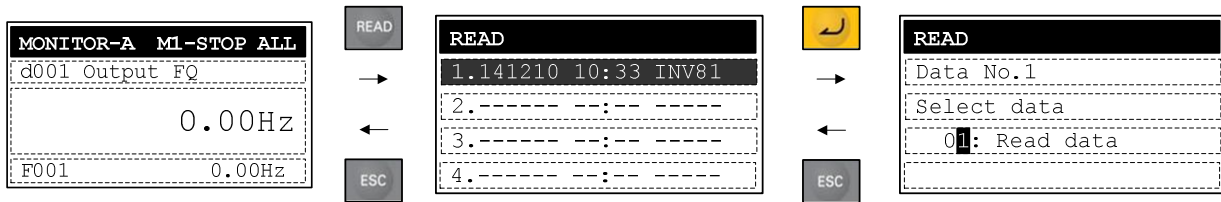

• In any display mode except Write Mode and Option Mode, the read screen is displayed after pressing the Key. If there aren't parameters stored in LCD digital operator, it will show "—".

• Use the or key to move the cursor up and down to select the memory number where parameter setting will be stored.

• After pressing the key the *Select data* available are:

- 01: Read data
- 02: Read data+EzSQ
- 03: Verify data
- 04: Verify EzSQ
- 05: Cancel

NOTE: only three selection items 01, 03 and 05 are displayed when memory No.2, No.3 or No.4 is selected.

• An overwritten confirming screen are displayed after the key is pressed. To approve, press the key, if not, press the key.

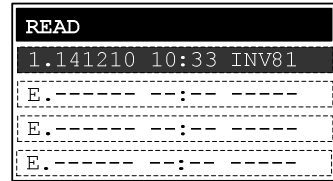
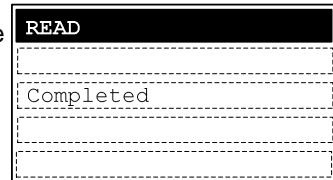
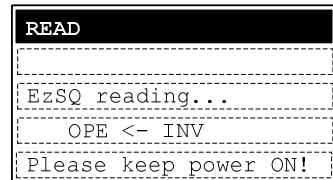
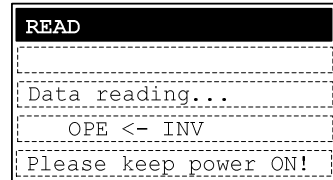
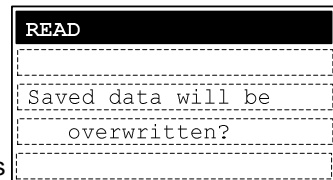
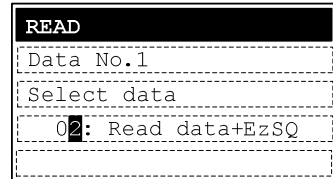
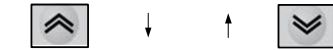

- The Read "Completed" will be displayed for 2 seconds.
- It returns to the Read Mode navigation layer automatically after the read function is completed. The read operation date and time and inverter type will be updated on the first line.
- Lines No. 2, No. 3 and No. 4 will display "E" as showed in the right figure.

4.4 R/W Storage Mode – Quad VERIFY function

With and without EzSQ (Drive Programming) inverter support

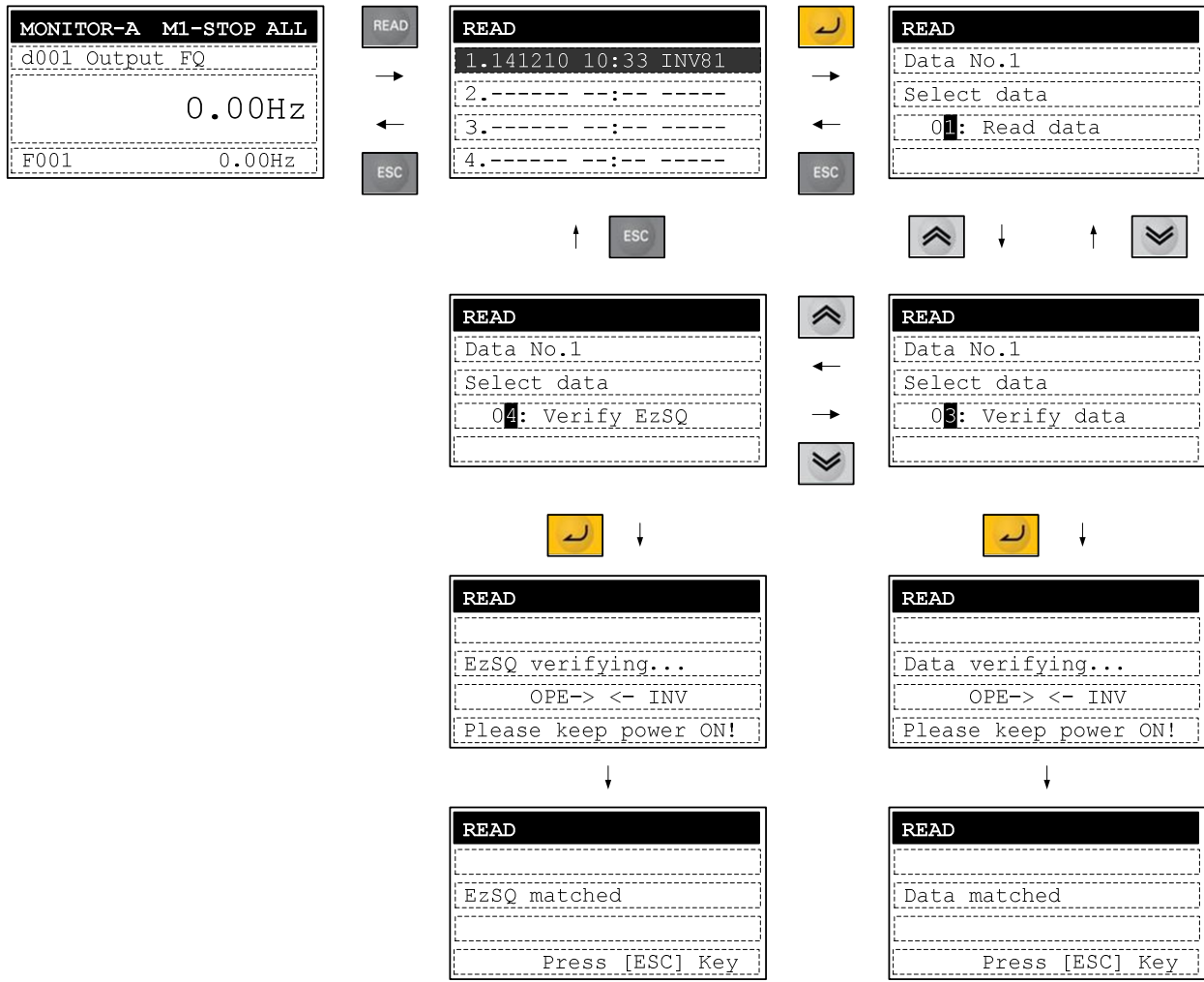

The result is shown automatically after the parameter or EzSQ (Drive Programming) verification is completed.

It returns to navigation level of Read mode after the **ESC** key is pressed.

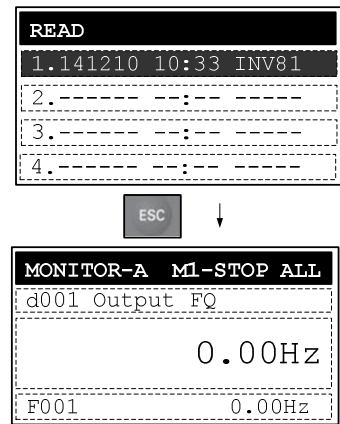

4.5 R/W Storage Mode - Quad - WRITE function

When the inverter does NOT support EzSQ (Drive Programming) function

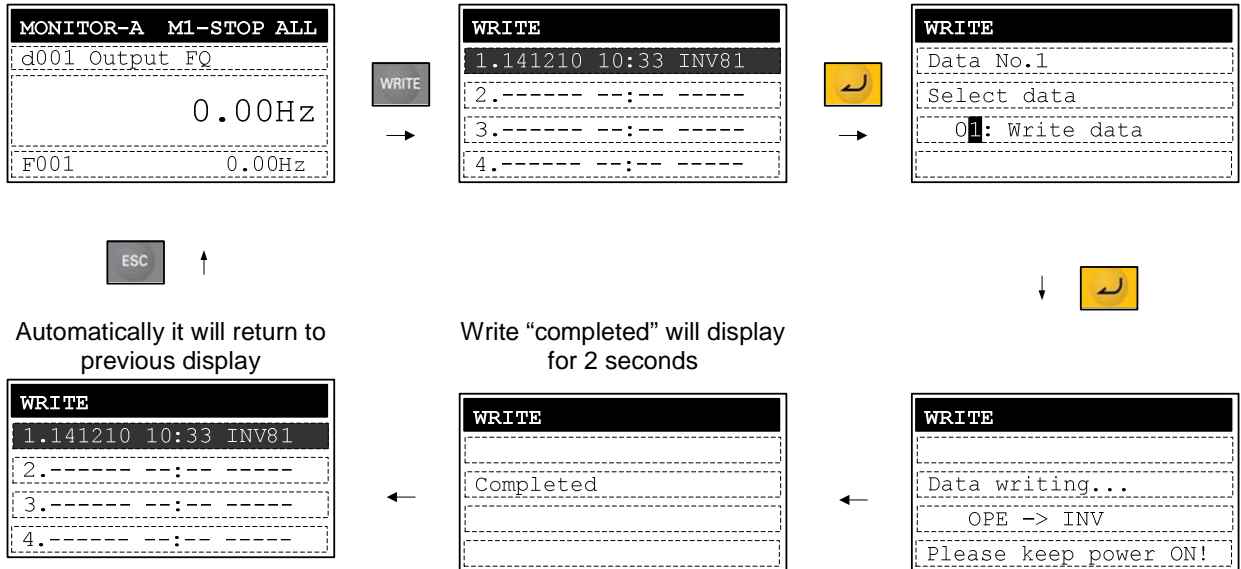

When the inverter supports EzSQ (Drive Programming) function

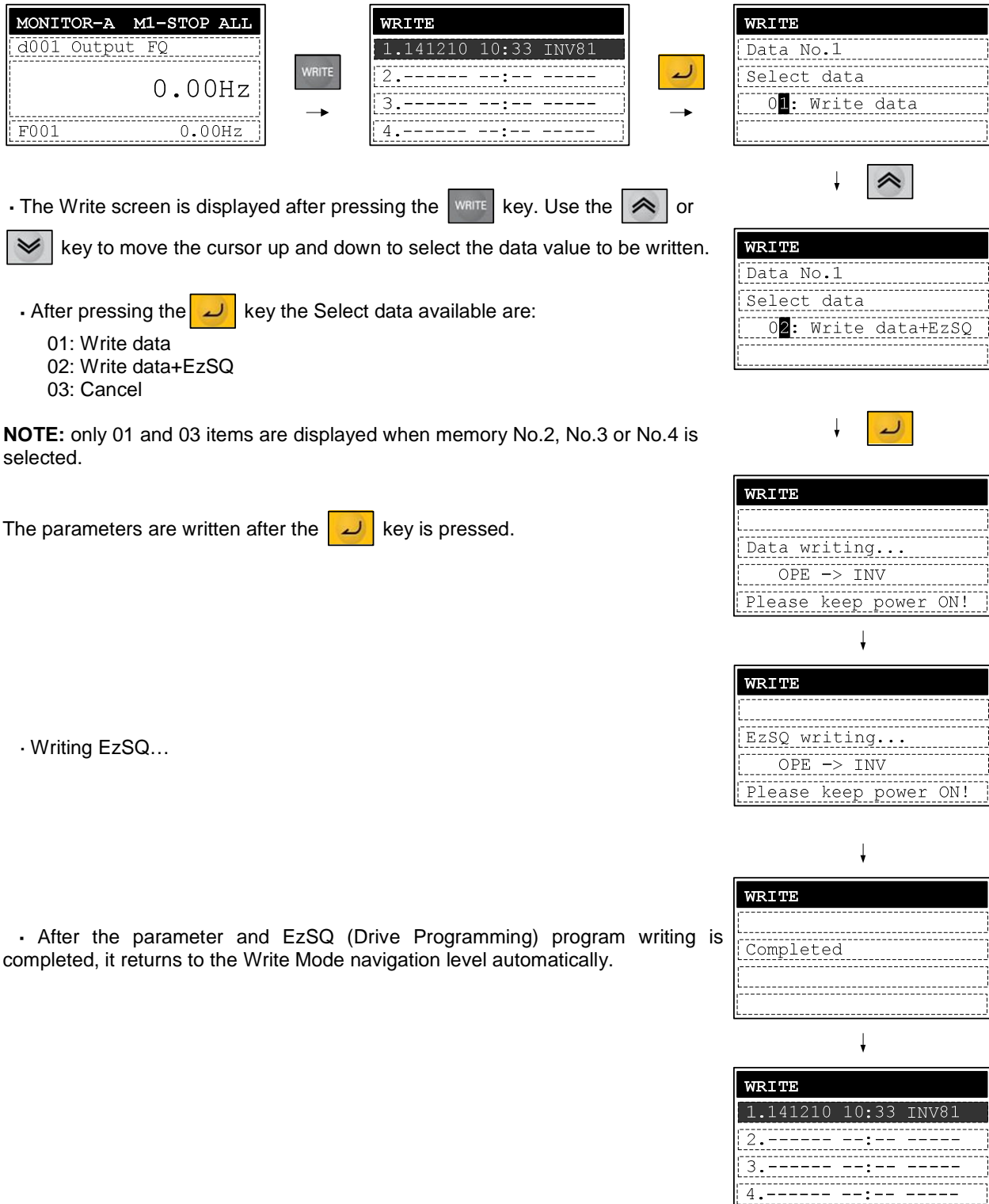

• The Write screen is displayed after pressing the **WRITE** key. Use the **↑** or **↓** key to move the cursor up and down to select the data value to be written.

- After pressing the **↵** key the Select data available are:
01: Write data
02: Write data+EzSQ
03: Cancel

NOTE: only 01 and 03 items are displayed when memory No.2, No.3 or No.4 is selected.

The parameters are written after the **↵** key is pressed.

• Writing EzSQ...

• After the parameter and EzSQ (Drive Programming) program writing is completed, it returns to the Write Mode navigation level automatically.

4.6 Operation condition of Read and Write function

Please note that the Read and Write functions are invalidated according to the inverter's state and setting as shown in the below table.

The operation condition of reading or verifying parameter

State and setting of the inverter	Only parameter	Parameter+EzSQ (Drive Programming)
Inverter is running, EzSQ (Drive Programming) is running, written unable	√	√
Soft locked (b031)	√	√
Display is limited (b037)	√	√
Password is being set	√	X
Trip happened	√	√

The operation condition of writing parameter

State and setting of inverter	Only parameter	Parameter+EzSQ (Drive Programming)
Inverter is running, EzSQ (Drive Programming) is running, written unable	X	X
Soft locked (b031)	X	X
Display is limited (b037)	√	√
Password is being set	√	X
Trip happened	X	X

5. Inverter setting concerning LCD Operator

The example below explains MX2 parameter settings concerning LCD digital operator.

Code	Function name	Content	Setting parameter
F001	Output Frequency setting	You could set the frequency when the frequency instruction is done from the operator.	Start Freq. ~ Max. Freq.
A001	Frequency source setting	Select the frequency source.	00: Keypad Potentiometer 01: Terminal 02: Digital Operator 03: Modbus 04: Option Card 06: Pulse train input 07: EzSQ (Drive Programming) 10: Operation function result
A002	Run command source setting	Select the run/stop command source.	01: Terminal 02: Digital Operator 03: Modbus 04: Option Card
b031	Software lock mode selection	This function prevents data changes.	00: Lock(SFT) 01: Only FQ(SFT) 02: Lock 03: Only FQ 10: RUN chg mode
b037	Function code display restriction	Parameter mode selection displayed in the LCD digital operator.	00: Full display 01: Function-specific display 02: User setting 03: Data comparison display 04: Basic display 05: Monitor display
b038	Initial-screen selection	Select the start display.	000: Last modified parameter. 001~060: Display set by d001~d060 201: F001 – Frequency Source
B166	Data R/W selection	Restrict the data read/write by LCD digital operator.	00: Read/Write OK 01: Protected
b087	Stop key selection	Enable/Disable the LCD Digital operator STOP key.	00: Enabling 01: Disabling 02: Disabling only stop
b164	Automatic return to the initial display	10 minutes after the last key operation, the display will return to the initial parameter set by b038.	00: Enable 01: Disable
C001 ~ C007	Intelligent Input terminal function	If it is set to 31(OPE) and the input is turned on, the frequency instruction and the run command source will be set from the LCD digital operator. If it is set to 51(F-TM) and the input is turned on, the frequency instruction and the run command source will be set to terminal mode. If it is set to 86(DISP) and the input is turned on, it will show the display set by parameter (b038).	31: OPE (Operator Control) 51: F-TM (Force Terminal Mode) 86: DISP (Display limitation)

6. Error Message

Error Messages displayed on the screen are classified into inverter error and LCD digital operator errors. They appear on the screen as shown below.

(1) Inverter error message

ERR1 *****

?ERROR *****

Note: For more details, please refer to the each inverter instruction manual.

(2) LCD digital operator error message

Display	Cause	Check item	Action	Resetting Method
COM ERROR	<ul style="list-style-type: none"> No signal is received from the inverter within 4 sec. 	<ul style="list-style-type: none"> Reset the inverter. Check Inverter type Check the connector for looseness/disconnection. Check the cable for break. 	<ul style="list-style-type: none"> Avoid issuing the RESET signal continuously for more than 5 sec. Change to correct Inverter type. Replace the cable and the connector 	Press STOP/RESET key
INV in RUN mode	<ul style="list-style-type: none"> The WRITE key is pressed while the inverter is running. Soft-lock is turned ON. 	<ul style="list-style-type: none"> Check if the WRITE key is pressed while the inverter is running. Check if the WRITE key is pressed while soft-lock is ON. 	<ul style="list-style-type: none"> The WRITE key should be pressed only while the inverter stops. Release the Soft-Lock (of the inverter). 	
INV in TRIP mode	<ul style="list-style-type: none"> WRITE key is pressed while inverter trips. 	<ul style="list-style-type: none"> Check if the inverter trips. 	<ul style="list-style-type: none"> Reset the inverter from trip status. 	
INV Type Un-match	<ul style="list-style-type: none"> An attempt was made writing parameters between different inverter type. 		<ul style="list-style-type: none"> Writing is possible only between the same type inverters. 	
Read lock enabled	<ul style="list-style-type: none"> In case of display "READ LOCK". 		<ul style="list-style-type: none"> Release the Read Lock. 	
Data Check Sum Error	<ul style="list-style-type: none"> EEPROM of LCD digital operator is overloaded. It reaches the EEPROM's Write Limitation 		<ul style="list-style-type: none"> If the same error appears after the power is supplied several times, the operator is defective. 	Supply the power again
INV Check Sum Error	<ul style="list-style-type: none"> The parameters in LCD digital operator and the parameters written into the inverter are unmatched. 		<ul style="list-style-type: none"> If the same error appears several times, the inverter is defective. (NOTE 1) 	

NOTE 1: It will happen sometimes when you try to write data into an inverter with different voltage class and capacity. (Please refer to each inverter instruction manual.)

7. Trouble shooting

For inverter trouble shooting, refer to the inverter instruction manual. In this section, the trouble shooting of the LCD digital operator will be described.

(1) No data appears on the screen

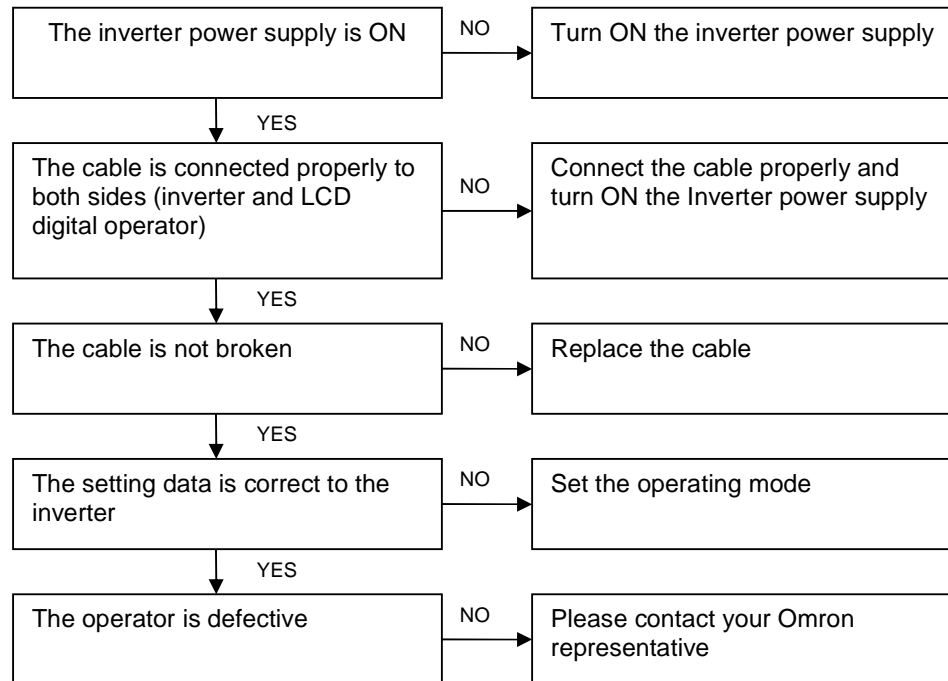

(2) Key operations are ignored

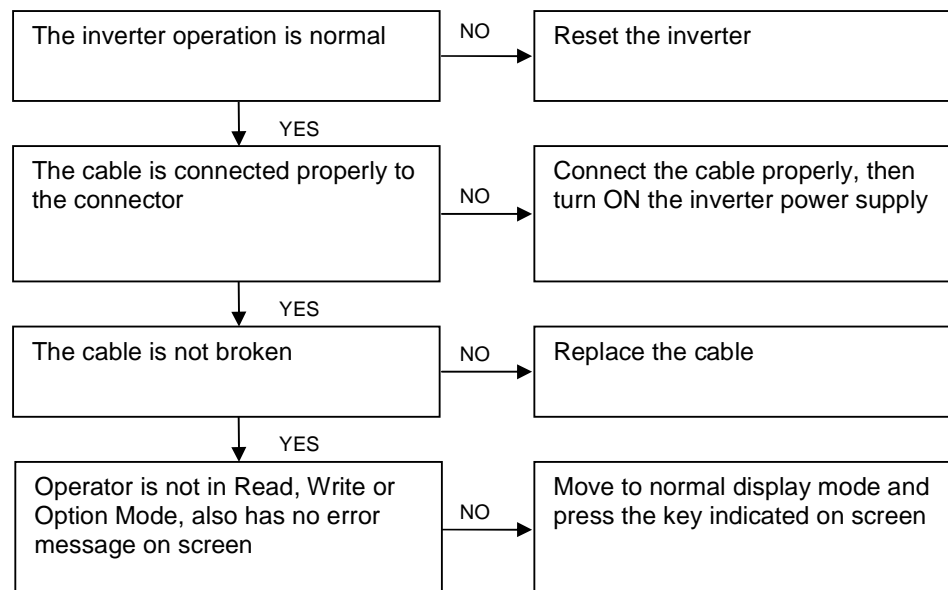

(3) If the operator screen becomes dark or characters cannot be identified, inductive noise may be entered from the cable. Separate LCD digital Operator cable more than 15cm from other cables. To reset the disturbed screen, turn ON any keys of LCD digital operator. If the same symptom appears again, turn OFF the inverter power supply or reset the terminal reset signal.

8. Specification

Specification	Contents
Model	LCD digital operator
Display	Digital display by LCD (132x64 dot)
Language display	10 languages
External dimensions	123(H) x 80(W) x 21(D)mm
Weight	0.1Kg
Power supply voltage	4.9 to 5.2 VDC
Ambient temperature	-10 to 50 degree C
Humidity	20 to 90% RH (no dew condensation)
Store temperature	-20 to 65 degree C
Place to use	1000m or less in height (at a place with no corrosion gas and dust)
Transmission method	RJ45 (RS-422)
Transmission rate	19.2Kbps/4800bps(switching)
Resin color	Black (Color n°: BK2D115)
Seat color	Black
Read frequency	100.000 times
Others	Built-in real time clock Backup time (Including power off status time):About 4 years@25 degree C Built-in battery: Coin type lithium battery CR1220

9. Battery exchange

There is a real time clock IC built-in. The power is supplied by a battery when outside power supply is turned off. When the battery comes to its life, the clock IC does not renew the time when power supply of LCD digital operator is turned off.

The clock date stored in the IC will be reset to a default value January 1, 2001 when power supply of LCD digital operator is turned on. Thus, the time of Trip mode, Read mode and Write mode cannot be displayed correctly unless the time is set properly in Option mode after power supply of LCD digital operator is turned on. However, there is no special bad influence for operating except displaying proper time.

When exchanging the battery, please disassemble the case by removing four screws backside of the operator. The plus pole of the battery (flat one) must be installed. Please take out the old battery using a thin minus driver, and be careful not to damage PCB and any part on the PCB.

