

Switching devices – Soft starters and solid-state switching devices



	Price groups PG 14O, 41B, 41C, 41E, 41H, 41L, 42G, 42J, 42S		Solid-state switching devices for resistive/inductive loads
6/2	Introduction	6/115	General data <u>Solid-state relays</u>
	SIRIUS 3RW soft starters	6/119	General data
6/5	General data <u>High Performance soft starters</u> 3RW55 soft starters	6/120	SIRIUS 3RF21 solid-state relays, 1-phase, 22.5 mm
6/14	- General data	6/126	SIRIUS 3RF20 solid-state relays, 1-phase, 45 mm
6/28	- Inline circuit	6/130	SIRIUS 3RF22 solid-state relays, 3-phase, 45 mm
6/32	- Inside-delta circuit		<u>Solid-state contactors</u>
6/36	- Accessories 3RW55 Failsafe soft starters	6/133	General data
6/38	- General data	6/134	SIRIUS 3RF23 solid-state contactors, 1-phase
6/50	- Inline circuit	6/144	SIRIUS 3RF24 solid-state contactors, 3-phase
6/51	- Inside-delta circuit		<u>Function modules</u>
6/52	- Accessories <u>General Performance soft starters</u> 3RW52 soft starters	6/148	General data
6/54	- General data	6/150	SIRIUS converters for 3RF2
6/66	- Inline circuit	6/151	SIRIUS load monitoring for 3RF2
6/68	- Inside-delta circuit	6/152	SIRIUS heating current monitoring for 3RF2
6/70	- Accessories <u>Basic Performance soft starters</u> 3RW50 soft starters	6/153	SIRIUS power controllers for 3RF2
6/72	- General data	6/155	SIRIUS power regulators for 3RF2
6/80	- Inline circuit		Solid-state switching devices for switching motors
6/81	- Accessories 3RW40 soft starters		<u>Solid-state contactors</u>
6/83	- General data	6/157	General data
6/91	- Inline circuit	6/160	SIRIUS 3RF34 solid-state contactors, 3-phase
6/93	- Accessories 3RW30 soft starters	6/164	SIRIUS 3RF34 solid-state reversing contactors, 3-phase
6/95	- General data		
6/103	- Inline circuit		
6/104	- Accessories <u>Spare parts</u>		
6/106	For 3RW55/3RW55 Failsafe		
6/110	For 3RW52		
6/113	For 3RW50 <u>Software</u>		
14/4	Simulation Tool for Soft Starters (STS)		
14/5	SIRIUS Soft Starter ES (TIA Portal)		
14/7	SIRIUS 3RW Soft Starter block library for SIMATIC PCS 7		
14/23	SIRIUS Sim		

Switching devices – Soft starters and solid-state switching devices

Introduction

Overview

More information

Homepage, see www.siemens.com/sirius-soft-starter
 Industry Mall, see www.siemens.com/product?3RW
 TIA Selection Tool Cloud (TST Cloud), see <https://www.siemens.com/tstcloud/?node=Sirius3rwFolder>

Industry Online Support (SIOS) topic page, see <https://support.industry.siemens.com/cs/ww/en/view/109747404>
 Simulation Tool for Soft Starters (STS), see page 6/9 or <https://support.industry.siemens.com/cs/ww/en/view/101494917>



3RW55



3RW55 Failsafe



3RW52



3RW50



3RW40



3RW30

Article No.	Page
3RW55...-HA..	6/14
3RW55...-HF..	6/38
3RW52	6/54

3RW soft starters

High Performance soft starters

3RW55 soft starters

- TIA integration optional
- Plug-in communication modules for PROFINET, PROFIBUS, EtherNet/IP and Modbus
- Removable HMI module with color display, local interface and slot for a micro SD memory card
- Extended protection functions
- Up to 1 200 kW at 400 V (can be used in supply systems up to 690 V)
- Automatic parameterization for simple commissioning and reliability even under changing load conditions
- Hybrid switching technology for minimum power loss and 3-phase motor control for optimum/symmetrical motor control
- Pump stop for reduced mechanical loading and optimum pump stop control
- ATEX/IECEX certification

3RW55...-HA..	6/14
---------------	------

3RW55 Failsafe soft starters

- TIA integration optional
- Plug-in communication modules for PROFINET, PROFIBUS, EtherNet/IP and Modbus
- Removable HMI module with color display, local interface and slot for a micro SD memory card
- Extended protection functions
- Up to 560 kW at 400 V (can be used in supply systems up to 480 V)
- SIL 1 - PL c / STO without additional components
- SIL 3 - PL e / STO with additional contactor and safety relay
- Hybrid switching technology for minimum power loss and 3-phase motor control for optimum/symmetrical motor control
- Pump stop for reduced mechanical loading and optimum pump stop control
- ATEX/IECEX certification

3RW55...-HF..	6/38
---------------	------

General Performance soft starters

3RW52 soft starters

- TIA integration optional
- Plug-in communication modules for PROFINET, PROFIBUS, EtherNet/IP and Modbus
- HMI modules optional
- Soft starting and stopping
- Current limiting
- Motor overload protection (optionally with thermistor motor protection)
- Analog output (optional)
- Up to 560 kW at 400 V (can be used in supply systems up to 600 V)
- Hybrid switching technology for minimum power loss and 3-phase motor control for optimum/symmetrical motor control
- Soft Torque for reduced mechanical loading and optimum pump stop
- Parameterization using potentiometers

3RW52	6/54
-------	------



3RW55



3RW55 Failsafe



3RW52



3RW50



3RW40



3RW30

Article No.	Page
3RW50	6/72
3RW40	6/83
3RW30	6/95

3RW soft starters

Basic Performance soft starters

3RW50 soft starters

- TIA integration optional
- Communication modules for PROFINET, PROFIBUS, EtherNet/IP and Modbus
- HMI modules optional
- Soft starting and stopping
- Current limiting
- Motor overload protection (optionally with thermistor motor protection)
- Analog output (optional)
- Up to 315 kW at 400 V (can be used in supply systems up to 600 V)
- Hybrid switching technology for minimum power loss and 2-phase motor control
- Soft Torque for reduced mechanical loading and optimum pump stop
- Parameterization using potentiometers
- ATEX/IECEX certification

3RW50

6/72

3RW40 soft starters

- Soft starting and stopping
- Current limiting
- Motor overload protection (optionally with thermistor motor protection)
- Up to 55 kW at 400 V (can be used in supply systems up to 600 V)
- Hybrid switching technology for minimum power loss and 2-phase motor control
- ATEX certification

3RW40

6/83

3RW30 soft starters

- Soft starting with voltage ramp
- Up to 55 kW at 400 V (can be used in supply systems up to 480 V)

3RW30

6/95

Use of SIRIUS 3RW soft starters in conjunction with IE3/IE4 motors

Note:

For the use of SIRIUS 3RW soft starters in conjunction with highly energy-efficient IE3/IE4 motors, please observe the information on dimensioning and configuring, see [Application Manual](#).

For more information, see [page 1/8](#).

Switching devices – Soft starters and solid-state switching devices

Introduction



3RF21



3RF20



3RF22



3RF23



3RF24



3RF29



3RF34 (motor)

Article No.	Page
-------------	------

SIRIUS solid-state switching devices for switching resistive/inductive loads

Solid-state relays

Solid-state relays

- Widths of 22.5 mm and 45 mm
- Compact and space-saving design
- "Zero-point switching" version
- Mounting onto existing cooling surfaces

3RF21	6/120
3RF20	6/126
3RF22	6/130

Solid-state contactors

Solid-state contactors

- Complete units comprising a solid-state relay and an optimized heat sink, "ready to use"
- Compact and space-saving design
- Versions for resistive loads "zero-point switching" and inductive loads "instantaneous switching"
- Special "low noise" and "short-circuit-proof" versions

3RF23	6/134
3RF24	6/144

Function modules

For extending the functionality of the 3RF21 solid-state relays and the 3RF23 solid-state contactors for many different applications

Converters

- For converting an analog input signal into an on/off ratio; can also be used on 3RF22 and 3RF24 3-phase switching devices

3RF2900-0EA18	6/150
---------------	-------

Load monitoring

- For load monitoring of one or more loads (partial loads)

3RF29..-0FA08, 3RF29.0-0GA1.	6/151
------------------------------	-------

Heating current monitoring

- For load monitoring of one or more loads (partial loads); remote teach

3RF29..-0JA..	6/152
---------------	-------

Power controllers

- For setting the current by means of a solid-state switching device depending on a setpoint value set by the power controller. There is a choice of full-wave control and generalized phase control.

3RF29..-0KA..	6/153
---------------	-------

Power regulators

- For regulating the current by means of a solid-state switching device, depending on a setpoint value set by the power regulator. Closed-loop control: full-wave control or generalized phase control

3RF29.0-0HA..	6/155
---------------	-------

SIRIUS solid-state switching devices for switching motors

Solid-state contactors

Solid-state contactors, solid-state reversing contactors

- Complete units in the insulated enclosure with integrated heat sink, "ready to use"
- Compact and space-saving design
- Version for motors, "instantaneous switching"

3RF34	6/160, 6/164
-------	--------------

Use of SIRIUS solid-state switching devices for switching motors in conjunction with IE3/IE4 motors

Note:

For the use of SIRIUS 3RF solid-state switching devices for switching motors in conjunction with highly energy-efficient IE3/IE4 motors, please observe the information on dimensioning and configuring, [see Application Manual](#).

For more information, [see page 1/8](#).

Switching devices – Soft starters and solid-state switching devices

SIRIUS 3RW soft starters

General data

Overview

More information

Homepage, see www.siemens.com/sirius-soft-starter
 Industry Mall, see www.siemens.com/product?3RW
 TIA Selection Tool Cloud (TST Cloud), see <https://www.siemens.com/tstcloud/?node=Sirius3rwFolder>
 Industry Online Support (SIOS) topic page, see <https://support.industry.siemens.com/cs/ww/en/view/109747404>

Simulation Tool for Soft Starters (STS), see page 6/9 or <https://support.industry.siemens.com/cs/ww/en/view/101494917>
 SIRIUS Soft Starter ES (TIA Portal), see page 6/9 or <https://support.industry.siemens.com/cs/ww/en/view/24230/dl>

SIRIUS 3RW soft starters – as versatile as your application

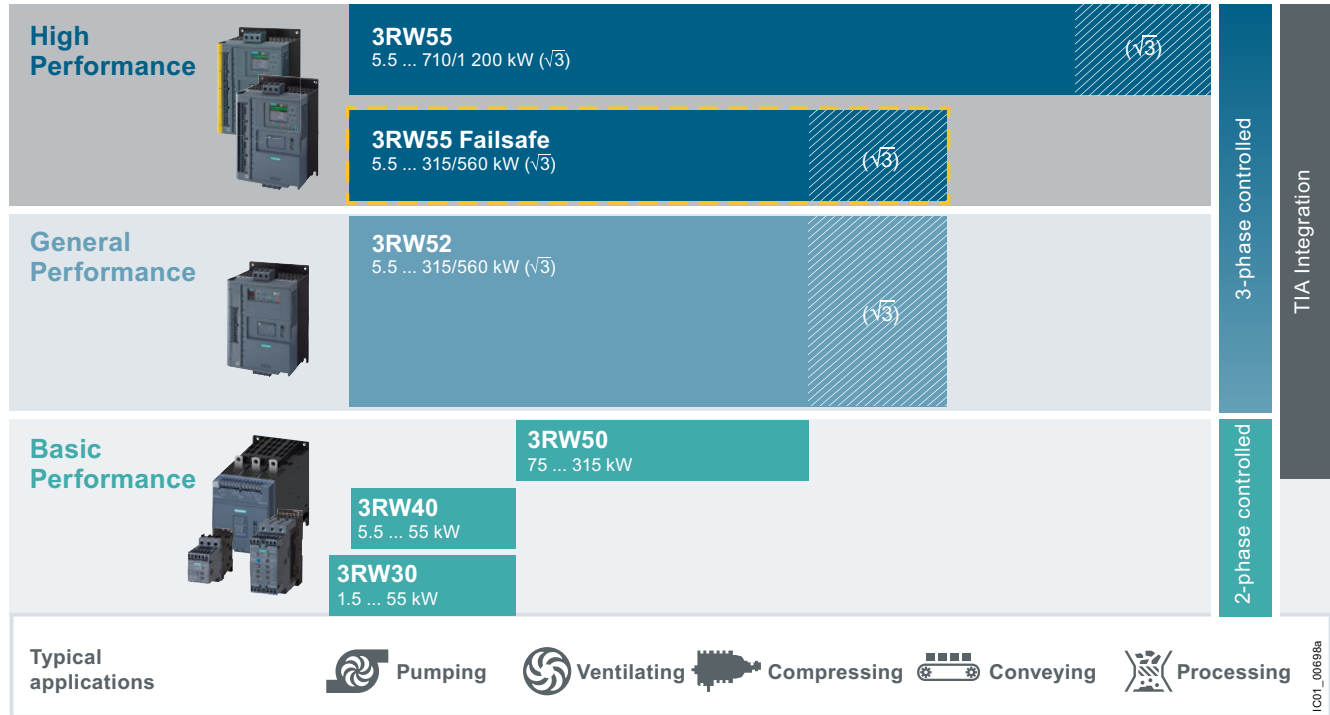

SIRIUS 3RW soft starters

Switching devices – Soft starters and solid-state switching devices

SIRIUS 3RW soft starters

General data



Applications	High Performance 3RW55/3RW55-F	General Performance 3RW52	Basic Performance		
SIRIUS soft starters			3RW50	3RW40	3RW30

Selection aid for soft starters

Normal starting (CLASS 10)

Pumps	●	●	●	●	●
Pumps with special pump stop (to prevent water hammer)	●	○	○		
Heat pumps	●	●	●	●	●
Hydraulic pumps	●	●	●	●	○
Presses	●	●	●	●	○
Conveyor belts	●	●	●	●	○
Roller conveyors	●	●	●	●	○
Screw conveyors	●	●	●	●	○
Escalators	●	●	●	●	
Piston compressors	●	●	●	●	
Screw compressors	●	●	●	●	
Small fans ¹⁾	●	●	●	●	
Centrifugal blowers	●	●	●	●	
Bow thrusters	●	●	●	●	

Heavy starting (CLASS 20)

Stirrers	●	○	○	○	
Extruders	●	○	○	○	
Lathes	●	○	○	○	
Milling machines	●	○	○	○	

Heavy starting (CLASS 30)

Large fans ²⁾	●				
Circular saws/bandsaws	●				
Centrifuges	●				
Mills	●				
Crushers	●				

- Recommended soft starter
- Possible soft starter

- 1) The mass inertia of the fan is <math><10</math> times the mass inertia of the motor.
- 2) The mass inertia of the fan is ≥ 10 times the mass inertia of the motor.

Switching devices – Soft starters and solid-state switching devices

SIRIUS 3RW soft starters

General data



Applications		High Performance		General Performance	Basic Performance		
SIRIUS soft starters		3RW55	3RW55-F	3RW52	3RW50	3RW40	3RW30
General technical specifications							
Operational current at 40 °C	A	13 ... 2 217	13 ... 987	13 ... 987	143 ... 570	12.5 ... 106	3 ... 106
Operational voltage	V	200 ... 690 ¹⁾	200 ... 480	200 ... 600	200 ... 600	200 ... 600	200 ... 480
Operating power for three-phase motors							
• At 400 V, at 40 °C							
- Inline circuit	kW	5.5 ... 710	5.5 ... 315	5.5 ... 315	75 ... 315	5.5 ... 55	1.5 ... 55
- Inside-delta circuit	kW	11 ... 1 200	11 ... 560	11 ... 560	--	--	--
• At 460/480 V at 50 °C							
- Inline circuit	hp	7.5 ... 1 000	7.5 ... 400	7.5 ... 400	100 ... 400	7.5 ... 75	1.5 ... 75
- Inside-delta circuit	hp	10 ... 1 700	10 ... 750	10 ... 750	--	--	--
Ambient temperature ²⁾	°C	-25 ... +60	-25 ... +60	-25 ... +60	-25 ... +60	-25 ... +60	-25 ... +60
Soft starting/stopping		✓	✓	✓	✓	✓	✓ ³⁾
Voltage ramp		✓	✓	✓	✓	✓	✓
Starting voltage	%	20 ... 100	20 ... 100	30 ... 100	30 ... 100	40 ... 100	40 ... 100
Ramp-up and ramp-down time	s	0 ... 360	0 ... 360	0 ... 20	0 ... 20	0 ... 20	0 ... 20 ³⁾
Pump stop (torque control) ⁴⁾		✓	✓	--	--	--	--
• Starting torque	%	10 ... 100	10 ... 100	--	--	--	--
• Torque limit	%	20 ... 200	20 ... 200	--	--	--	--
Soft Torque (torque limit)		--	--	✓	✓	--	--
Integral bypass contact system		✓	✓	✓	✓	✓	✓
Intrinsic device protection		✓	✓	✓	✓	✓	--
Motor overload protection		✓ ⁵⁾	✓ ⁵⁾	✓	✓ ⁵⁾	✓ ⁵⁾	--
Thermistor motor protection evaluation		✓	✓	✓ ⁶⁾	✓ ⁶⁾	✓ ⁶⁾	--
Analog output		✓	✓	✓ ⁶⁾	✓ ⁶⁾	--	--
Remote RESET		✓	✓	✓	✓	✓	--
Adjustable current limiting		✓	✓	✓	✓	✓	--
Inside-delta circuit ¹⁾		✓	✓	✓	--	--	--
Breakaway pulse		✓	✓	--	--	--	--
Automatic parameterization		✓	✓	--	--	--	--
Pump cleaning		✓	✓	--	--	--	--
Condition monitoring		✓	✓	--	--	--	--
User account administration ⁷⁾		✓	✓	--	--	--	--
Creep speed in both directions of rotation		✓	--	--	--	--	--
Reversing duty		✓	✓	--	--	--	--
Reversing DC braking ⁴⁾⁸⁾		✓	--	--	--	--	--
DC braking ⁴⁾⁸⁾		✓	--	--	--	--	--
Dynamic DC braking ⁴⁾⁸⁾		✓	--	--	--	--	--
Motor heating		✓	--	--	--	--	--
Communication function ⁹⁾		✓	✓	✓	✓	--	--
HMI module installable in the cabinet door		✓	✓	✓ ⁹⁾	✓ ⁹⁾	--	--
Operating measured value display		✓	✓	✓ ⁹⁾	✓ ⁹⁾	--	--
Logbooks		✓	✓	✓ ⁹⁾	✓ ⁹⁾	--	--
Statistical data and slave pointer function		✓	✓	✓ ⁹⁾	✓ ⁹⁾	--	--
Trace function ⁷⁾		✓	✓	--	--	--	--
Programmable control inputs and outputs		✓	✓	--	--	--	--
Number of parameter sets		3	3	1	1	1	1
Parameterizable via software ⁷⁾		✓	✓	--	--	--	--
Number of controlled phases		3	3	3	2	2	2
Heavy starting CLASS 30 ⁴⁾		✓	✓	--	--	--	--

✓ Function available

-- Function not available

1) Inside-delta circuit only up to operational voltage 600 V.

2) Note derating above 40 °C.

3) Only soft starting available for 3RW30.

4) Calculate soft starter and motor with size allowance where required.

5) When using the motor overload protection according to ATEX/IECEX, an upstream contactor may be required, see page 6/12.

6) Special device versions only.

7) With software Soft Starter ES (TIA Portal).

8) Not possible in inside-delta circuit.

9) Only in conjunction with special accessories.

Switching devices – Soft starters and solid-state switching devices

SIRIUS 3RW soft starters

General data

Constraints

The 3RW soft starters should always be designed on the basis of the required rated operational current of the motor. The motor ratings listed in the selection and ordering data are rough guide values and designed for basic starting conditions (CLASS 10). For other starting conditions we recommend the Simulation Tool for Soft Starters (STS).

Motor rating data in kW and hp is based on IEC 60947-4-1.

At an installation altitude above 2 000 m, the max. permissible operational voltage is reduced to 480 V.

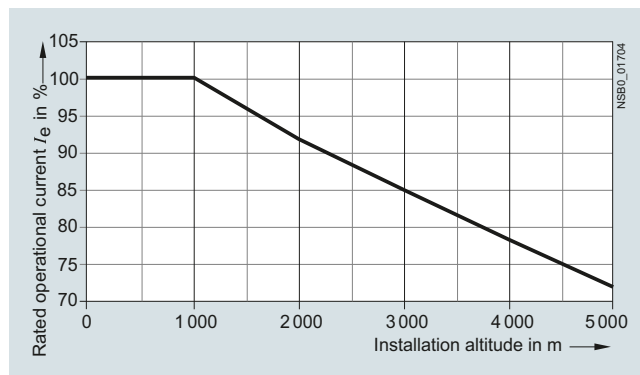

Installation altitude for SIRIUS 3RW soft starters

The selection and ordering data were determined for the following constraints (stand-alone installation without auxiliary fan)



Applications		High Performance	General Performance	Basic Performance		
SIRIUS soft starters		3RW55/3RW55-F	3RW52	3RW50	3RW40	3RW30
Constraints						
Maximum starting time	s	20	10			3
Maximum starting current in % of motor current	I_e	300				
Maximum number of starts per hour	1/h	5				20

Switching devices – Soft starters and solid-state switching devices

SIRIUS 3RW soft starters

General data

Simulation Tool for Soft Starters (STS) (see page 14/4)

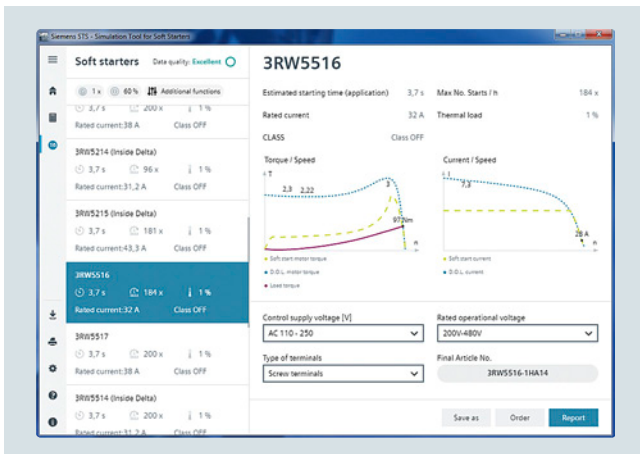

Easy input of motor and load data

The Simulation Tool for Soft Starters (STS) provides a convenient means of designing soft starters using a simple, quick and easy-to-use interface. Entering the motor and load data will simulate the application and prompt suggestions for suitable soft starters.

- Simple, quick and user-friendly interface
- Detailed and up-to-date Siemens motor database, including IE3/IE4 motors.
- Simulation of heavy starting up to CLASS 30
- Update-capable (e.g. motors, load types, functions)
- Fast simulations with minimum input data
- Immediate, graphical curve charts of start operations with limit values
- Table view of suitable soft starters for the application

The Simulation Tool for Soft Starters (STS) is available as a free download for Windows and as an app (for Android and iOS).

SIRIUS Soft Starter ES (TIA Portal) (see page 14/5)

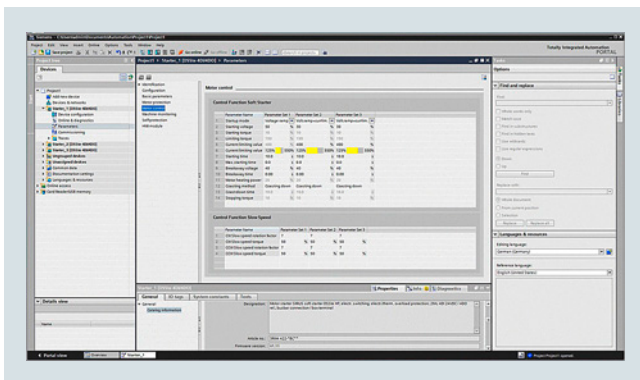

Easy and clearly arranged parameter setting of the SIRIUS 3RW44 and 3RW55 soft starters with SIRIUS Soft Starter ES (TIA Portal)

The SIRIUS Soft Starter ES (TIA Portal) software permits quick and easy parameterization, monitoring and diagnostics of SIRIUS 3RW44 and 3RW5 soft starters for service purposes.

- Transparent setting of the device functions and their parameters – online and offline
- Effective diagnostic functions on the soft starter and display of the most important measured values

- Trace function (oscilloscope function) for recording measured values and events (in the Standard and Premium software versions)
- Time savings through shorter startup times
- Fast, low-cost licensing using a simple licensing procedure (also available online)

SIRIUS 3RW Soft Starter block library for SIMATIC PCS 7 (see page 14/7)

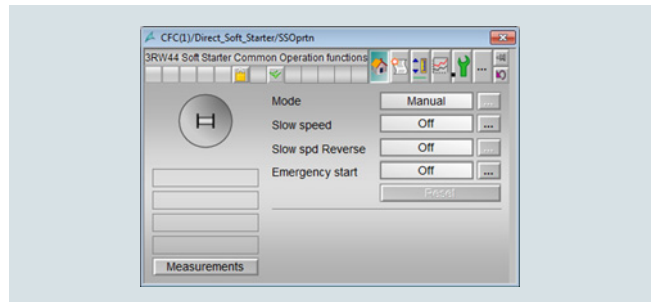

Faceplate of the motor block

The SIRIUS 3RW Soft Starter block library for PCS 7 can be used for simple and convenient integration of SIRIUS 3RW44, 3RW52 and 3RW55 soft starters into the SIMATIC PCS 7 process control system.

The SIRIUS 3RW Soft Starter block library for PCS 7 contains the diagnostics and driver blocks that correspond to the SIMATIC PCS 7 diagnostics and driver concept as well as the elements (symbols and faceplates) required for operator control and process monitoring.

SIRIUS Sim (see page 14/23)

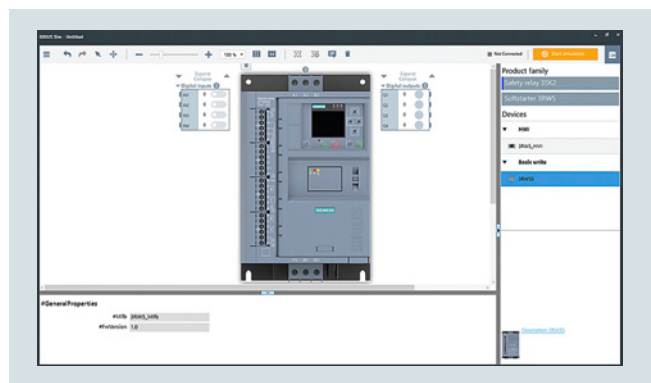

SIRIUS Sim 3RW55

The SIRIUS simulation tool can be used to quickly and easily test functions and configurations in an office environment. These configurations can then be loaded directly into real devices.

SIRIUS Sim V2.0 integrates the SIRIUS 3RW55 soft starters with the following features:

- Complete parameterization of the SIRIUS 3RW55 High Performance soft starters
- Complete navigation with the same menu structure as on the HMI
- Optional storage of the parameterization on a micro SD memory card for transfer to the real soft starter
- Simulation of starting and stopping, including operating phases as well as different fault conditions

SIRIUS Sim is available as a free download.

Switching devices – Soft starters and solid-state switching devices

SIRIUS 3RW soft starters

General data

Circuit concept

3-phase controlled SIRIUS 3RW soft starters can be operated in two different types of circuit:

- **Inline circuit**
The controls for isolating and protecting the motor are simply connected in series with the soft starter. The motor is connected to the soft starter with three cables.
- **Inside-delta circuit**
The wiring is similar to that of wye-delta starters. The phases of the soft starter are connected in series with the individual motor windings. The soft starter then only has to carry the phase current, amounting to about 58% of the rated motor current (conductor current).

Comparison of the types of circuit

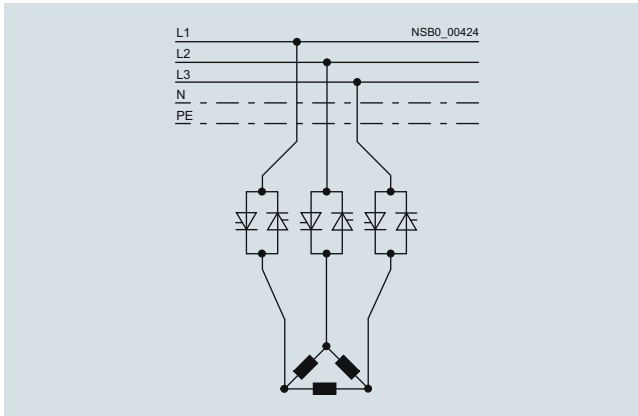

Inline circuit: Rated current I_e corresponds to the rated motor current I_n , three cables to the motor

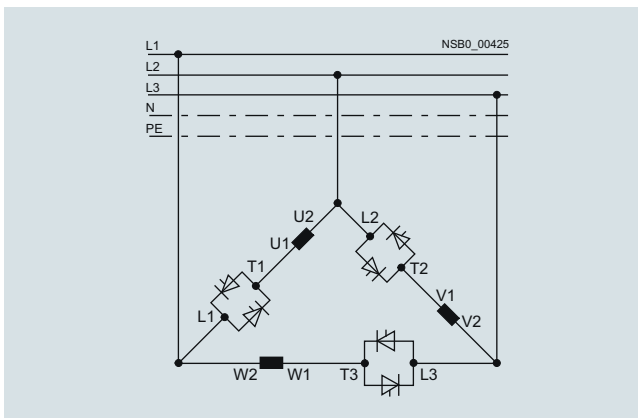

Inside-delta circuit: Rated current I_e corresponds to approx. 58% of the rated motor current I_n , six cables to the motor (as for wye-delta starters)

Which circuit?

Using the inline circuit involves the lowest wiring outlay. If the soft starter to motor connections are long, this circuit is preferable.

The wiring complexity is twice as high when using the inside-delta circuit, but a smaller device can be used with the same rating. Thanks to the choice of operating mode between the inline circuit and inside-delta circuit, it is always possible to select the most favorable solution.

The braking function is possible only in the inline circuit. The inside-delta circuit cannot be used in 690 V line supplies.

Configuration

The solid-state 3RW soft starters are designed for normal starting. In case of heavy starting or increased starting frequency, a larger unit must be selected. The 3RW50 and 3RW52 soft starters may be used in isolated supply networks (IT systems) up to 600 V AC and the 3RW55 soft starters even up to 690 V.

For long starting times it is recommended to have a PTC sensor or temperature switch in the motor. This also applies for the ramp-down modes torque control, pump stop and DC braking, because during the ramp-down time in these modes, an additional current loading applies in contrast to free ramp-down.

No capacitive elements are permitted in the motor feeder between the SIRIUS 3RW soft starter and the motor (e.g. no reactive-power compensation equipment). In addition, neither static systems for reactive-power compensation nor dynamic PFC (Power Factor Correction) must be operated in parallel during starting and stopping of the soft starter. This is important to prevent faults arising on the compensation equipment and/or the soft starter.

All elements of the main circuit (such as fuses and controls) should be dimensioned for direct-on-line starting, following the local short-circuit conditions. Fuses and switching devices must be ordered separately. The harmonic component load of the starting current must be taken into consideration for the selection of motor starter protectors (selection of release). Please observe the maximum switching frequencies specified in the technical specifications.

Notes:

When three-phase motors are switched on, voltage drops occur as a rule on starters of all types (direct-on-line starters, wye-delta starters, soft starters). The infeed transformer must always be dimensioned such that the voltage dip when starting the motor remains within the permissible tolerance. If the infeed transformer is dimensioned with only a small margin, it is best for the control voltage to be supplied from a separate circuit (independently of the main voltage) in order to avoid the potential switching off of the soft starter.

For dimensioning soft starters, we recommend our Simulation Tool for Soft Starters (STS), see page 6/9 or our Technical Support, www.siemens.com/support-request.

Recommended parameters for the initial commissioning of our SIRIUS 3RW soft starters are listed in every report of our Simulation Tool for Soft Starters (STS). In addition, our High Performance soft starters provide support by means of their commissioning wizards.

Switching devices – Soft starters and solid-state switching devices

SIRIUS 3RW soft starters

General data

Motor feeders with soft starters

The type of coordination according to which the motor feeder with soft starter is mounted depends on the application-specific requirements. Normally, fuseless mounting (combination of motor starter protector and soft starter) is sufficient.

If type of coordination "2" is to be fulfilled, then semiconductor fuses must be fitted in the motor feeder.

T_{OC}
1

Type of coordination "1" according to IEC 60947-4-1: After a short-circuit incident, the unit is defective and therefore unsuitable for further use (protection of persons and system guaranteed).

T_{OC}
2

Type of coordination "2" according to IEC 60947-4-1: After a short-circuit incident the unit is suitable for further use (protection of persons and system guaranteed).

The type of coordination refers to soft starters in combination with the stipulated protective device (motor starter protector/fuse), not to any additional components in the feeder.

The types of coordination are indicated in the corresponding tables by the symbols shown on orange backgrounds.

Feeder tests and events

To keep the scope of feeder tests with SIRIUS 3RW soft starters within economically reasonable limits, tests were conducted with feeder components (motor starter protectors/circuit breakers, fuses) that cover the greatest number of use cases (different soft starter versions depending on, for example, line voltage, type of circuit, or necessary overdimensioning). For the combined tests that were conducted, the values for the short-circuit breaking capacity I_{q1} in kA were determined and documented.

If the short-circuit breaking capacity is the same, of course, smaller circuit breakers or fuses can also be used for the selected soft starter provided the dimensioning of the short-circuit components is suitable for the connected three-phase motor and the line protection for the cables used. For type of coordination "2" (with semiconductor protection), it is also necessary to compare the characteristics because the protection function would no longer be completely ensured if too small a fuse were selected. If the soft starter does not have a motor protection function, the motor protection must also be dimensioned appropriately.

Setting the motor current

If circuit breakers with an overload release are used (e.g. SIRIUS 3RV20 motor starter protector), we recommend activating the motor protection function of the SIRIUS 3RW soft starter to protect the motor and setting the soft starter to the rated operational current I_e of the motor. We recommend setting the circuit breaker in such a way that it provides line protection but does not usually trip before the soft starter when a motor overload occurs.

Line protection and motor protection

Line protection and motor protection are not ensured in all operating cases, depending on:

- How the motor feeder is constructed (e.g. with fuses or motor starter protectors)
- Whether the SIRIUS 3RW soft starters are operated within the specification relevant for the tests (IEC 60947-4-2)
- Or whether the documented constraints (see page 6/8) have been observed

There are operating states of the thyristors (caused, for example, by high starting frequencies or heavy starting) that do not permit an overload to be disconnected by the SIRIUS 3RW soft starter. These cases are very rare but can not be ruled out in all cases.

In accordance with IEC 60947-4-2, the SIRIUS 3RW soft starters are dimensioned and checked for operation with up to 8 times the rated operational current I_e . For currents larger than this, reliable disconnection of an overcurrent by the SIRIUS 3RW soft starter is not ensured. Such large overcurrents have to be disconnected by a switching device at a higher level (e.g. by a circuit breaker or a fuse in conjunction with an optional line contactor).

Motor protection by the SIRIUS 3RW soft starter is ensured for currents up to 8 times the rated operational current I_e in any case. Line protection is covered by the line-side motor starter protector/circuit breaker or fuse.

These motor feeder components must be dimensioned accordingly and the cable cross-sections must be chosen to match.

Line protection

Line protection in motor feeders with soft starters is always covered by a fuse or a circuit breaker both in case of an overload and in case of a short circuit. The circuit breaker must have an overload release. That is the case for motor starter protectors (e.g. SIRIUS 3RV20).

Circuit breakers without an overload release (e.g. SIRIUS 3RV23 motor starter protectors) must not be used because they do not provide overload protection. The feeder tests for these were therefore not performed. If the motor feeder with SIRIUS 3RW soft starters is configured without a fuse, motor starter protectors must be used that ensure tripping on an overload in all cases.

Motor protection

If fuses are used to provide protection against overload and short circuit of the cables, the motor is protected by the SIRIUS 3RW soft starter. If the constraints (simple starting conditions CLASS 10, listed maximum values for starting current, starting time and number of starts per hour) of page 6/8 are observed, the motor feeders can be configured according to IEC as described in the section about soft starters (an optional line contactor is not required). If these preconditions are met, the SIRIUS 3RW soft starters are able to trip on overloads to protect the motor in any case.

In other starting conditions and on heavy starting, the following must be considered:

Trip classes

Tested fuseless switchgear assemblies comprising SIRIUS 3RW soft starters and motor starter protectors only comply with CLASS 10.

To configure tested motor feeders, for example, for CLASS 20 or CLASS 30, fuses must be used together with SIRIUS 3RW soft starters.

Line contactor

In applications with high starting frequencies or heavy starting as of CLASS 20, we recommend combining fuses with the use of a line contactor on the line side so that a motor overload is disconnected by the fault signaling contact of the soft starter in any case (that is, even in rare cases in which disconnection by the SIRIUS 3RW soft starter is no longer possible due to the operating state of the thyristors).

Switching devices – Soft starters and solid-state switching devices

SIRIUS 3RW soft starters

General data

ATEX/IECEX-certified motor overload protection

Ambient temperature during operation

The SIRIUS 3RW soft starters are approved for operation in a temperature range of -25 to +60 °C.

Please take into account derating of the rated operational current for ambient temperatures above 40 °C.

For more information, see [Equipment Manual and the technical product data sheet of the selected soft starter](#).

Trip class (electronic overload protection)

The motor and cables must be dimensioned for the selected trip class.

The rated data of the soft starters refers to normal starting (CLASS 10). For heavy starting (> CLASS 10), the soft starter may need to be oversized as only a rated motor current that is lower than the soft starter rated current can be set.

Short-circuit protection

The SIRIUS 3RW soft starter does not have short-circuit protection. Short-circuit protection must be ensured.

Line protection

Avoid impermissibly high cable surface temperatures by correctly dimensioning the cross-sections.

The cable cross-section must be adequately dimensioned.

Line contactor or additional undervoltage release on the motor starter protector

In many ATEX/IECEX applications no additional measures (e.g. the use of a line contactor) are necessary with regard to the motor feeder configuration.

The operation of the selected soft starter may, depending on the amplitude of the line voltage and the type of motor connection (inline circuit or inside-delta circuit), result in the loss of the certified motor overload protection according to ATEX/IECEX if one of the two remedial measures listed below is not implemented.

Remedial measures

- An additional line contactor in the main circuit
- An additional undervoltage release for a motor feeder configuration with a motor starter protector

The line contactor or the undervoltage release are connected to error outputs 95, 96 and 98 of the selected soft starter

Note:

For ATEX/IECEX applications, the accompanying information on parameterization and commissioning must be observed in the ATEX/IECEX chapters of the [Equipment Manual](#) for the selected soft starter.

Article No. scheme

Product versions	Article number	
Device type	High Performance soft starters	3RW55 <input type="checkbox"/> <input type="checkbox"/> - <input type="checkbox"/> <input type="checkbox"/> <input type="checkbox"/> <input type="checkbox"/> <input type="checkbox"/>
	General Performance soft starters	3RW52 <input type="checkbox"/> <input type="checkbox"/> - <input type="checkbox"/> <input type="checkbox"/> <input type="checkbox"/> <input type="checkbox"/> <input type="checkbox"/>
	Basic Performance soft starters	3RW50 <input type="checkbox"/> <input type="checkbox"/> - <input type="checkbox"/> <input type="checkbox"/> <input type="checkbox"/> <input type="checkbox"/> <input type="checkbox"/>
		3RW40 <input type="checkbox"/> <input type="checkbox"/> - <input type="checkbox"/> <input type="checkbox"/> <input type="checkbox"/> <input type="checkbox"/> <input type="checkbox"/>
3RW30 <input type="checkbox"/> <input type="checkbox"/> - <input type="checkbox"/> <input type="checkbox"/> <input type="checkbox"/> <input type="checkbox"/> <input type="checkbox"/>		
Size/rated operational current I_e	e.g. 15 = 25 A in size S1	<input type="checkbox"/> <input type="checkbox"/>
Connection type	e.g. 1 = screw terminal	<input type="checkbox"/>
Soft starter functionality	e.g. AC = with bypass and analog output, 3-phase controlled	<input type="checkbox"/> <input type="checkbox"/>
Rated control supply voltage U_s	e.g. 0 = 24 V AC/DC	<input type="checkbox"/>
Rated operational voltage U_e	e.g. 4 = 200 ... 480 V AC	<input type="checkbox"/>
Example		3RW52 1 5 - 1 A C 0 4

Note:

The Article No. scheme shows an overview of product versions for better understanding of the logic behind the article numbers.

For your orders please use the article numbers quoted in the selection and ordering data.

Switching devices – Soft starters and solid-state switching devices

SIRIUS 3RW soft starters

General data

Benefits

Can be flexibly deployed in many applications

Strong portfolio:
Wide range of matching products

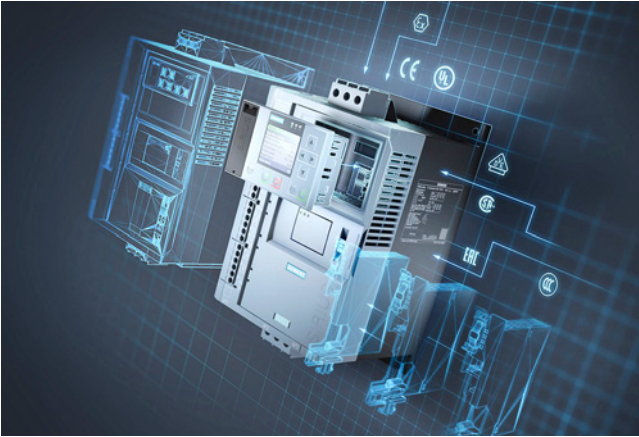

- The right hardware for all requirements, soft starters for tasks ranging from simple to demanding starting in Basic, General and High Performance versions
- Extensive portfolio for individual expansion: Optional HMIs for installation in the device or mounting on the control cabinet door
- Communication via PROFINET, PROFIBUS, EtherNet/IP and Modbus
- Design enclosure with removable terminals, space-saving thanks to compact design and rugged thanks to coated printed circuit boards
- Can be used worldwide thanks to numerous certificates and approvals: IEC, UL, CSA, CCC, ATEX/IECEX, shipbuilding

Intelligent operation:
concentrated, application-specific functionality

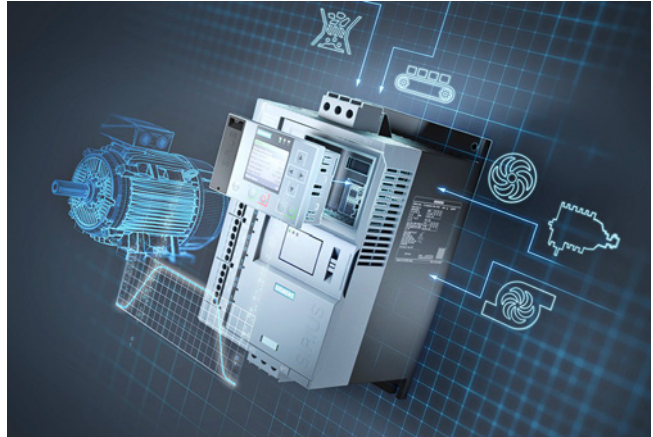

- Can be used in a wide variety of applications: Pumping, ventilating, compressing, moving and processing
- Integrated, self-learning automatic parameterization depending on motor starting conditions
- Application-specific functionality such as pump cleaning and pump stop
- Condition monitoring: Current and power monitoring with warning and alarm limits, starting time monitoring

Efficient switching:
hybrid switching technology on board

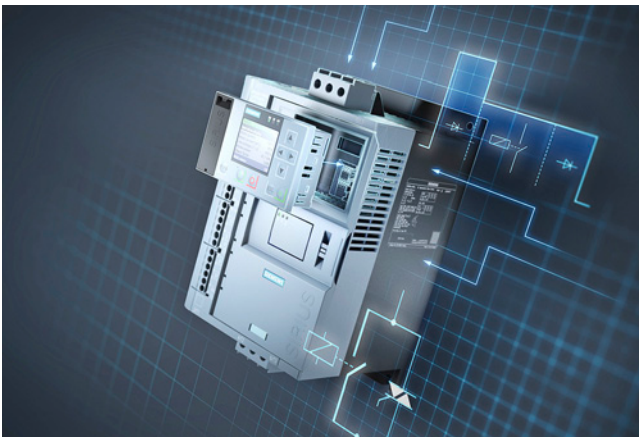

- Energy-efficient switching and mechanical protection of the drive train thanks to soft starters with hybrid switching technology
- Low-wear switching extends the service life of the devices
- Soft starting prevents current peaks, thereby increasing the network stability
- Protection against disturbances in the application: Mechanical protection for the drive train

Ready for a digital future:
data available whenever and wherever needed

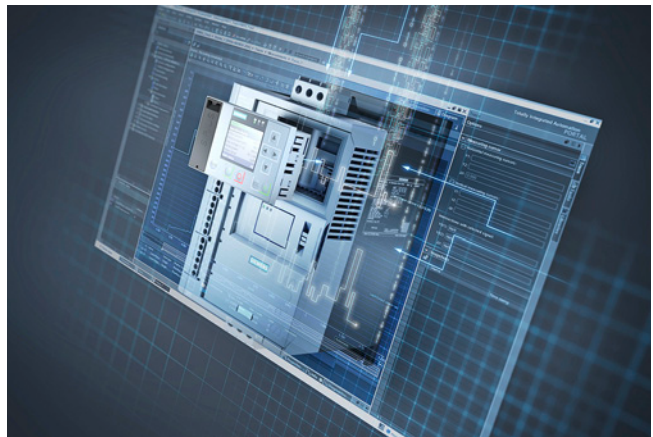

- Support from tools and data during engineering
- Simulation Tool for Soft Starters for support during product selection
- Very simple, standardized commissioning and configuration via Soft Starter ES in TIA Portal
- Integration in the automation system via communication interfaces
- Data availability and analysis: large volumes of data at any time and anywhere, even into MindSphere

6

Switching devices – Soft starters and solid-state switching devices

SIRIUS 3RW soft starters

High Performance soft starters

3RW55 soft starters > General data

Overview

More information

Homepage, see www.siemens.com/sirius-soft-starter
 Industry Mall, see www.siemens.com/product?3RW55
 TIA Selection Tool Cloud (TST Cloud), see <https://www.siemens.com/tstcloud/?node=3rw55>
 Industry Online Support (SIOS) topic page, see <https://support.industry.siemens.com/cs/ww/en/view/109747404>

Simulation Tool for Soft Starters (STS), see page 6/9 or <https://support.industry.siemens.com/cs/ww/en/view/101494917>

SIRIUS Soft Starter ES (TIA Portal), see page 6/9 or <https://support.industry.siemens.com/cs/ww/en/view/24230/dl>

SIRIUS 3RW Soft Starter block library for SIMATIC PCS 7, see page 6/9 or <https://support.industry.siemens.com/cs/ww/en/view/109770336>

SIRIUS Sim, see page 6/9 or <https://support.industry.siemens.com/cs/ww/en/view/109763750>



Equipped with the utmost functionality, the SIRIUS 3RW55 High Performance soft starters confidently handle even difficult starting and stopping operations. Thanks to innovative torque control, the device can be used for drives with an output of between 5.5 kW and 1 200 kW (at 400 V).

The functions have been specially designed to offer maximum user friendliness. The HMI (with color display, local interface and a slot for micro SD memory card) and plug-in communication modules (PROFINET, PROFIBUS, EtherNet/IP and Modbus) ensure maximum flexibility.

With their modern hybrid switching technology, the SIRIUS 3RW55 soft starters offer efficient switching for long-term, energy-saving use.

SIRIUS 3RW55 soft starters device family

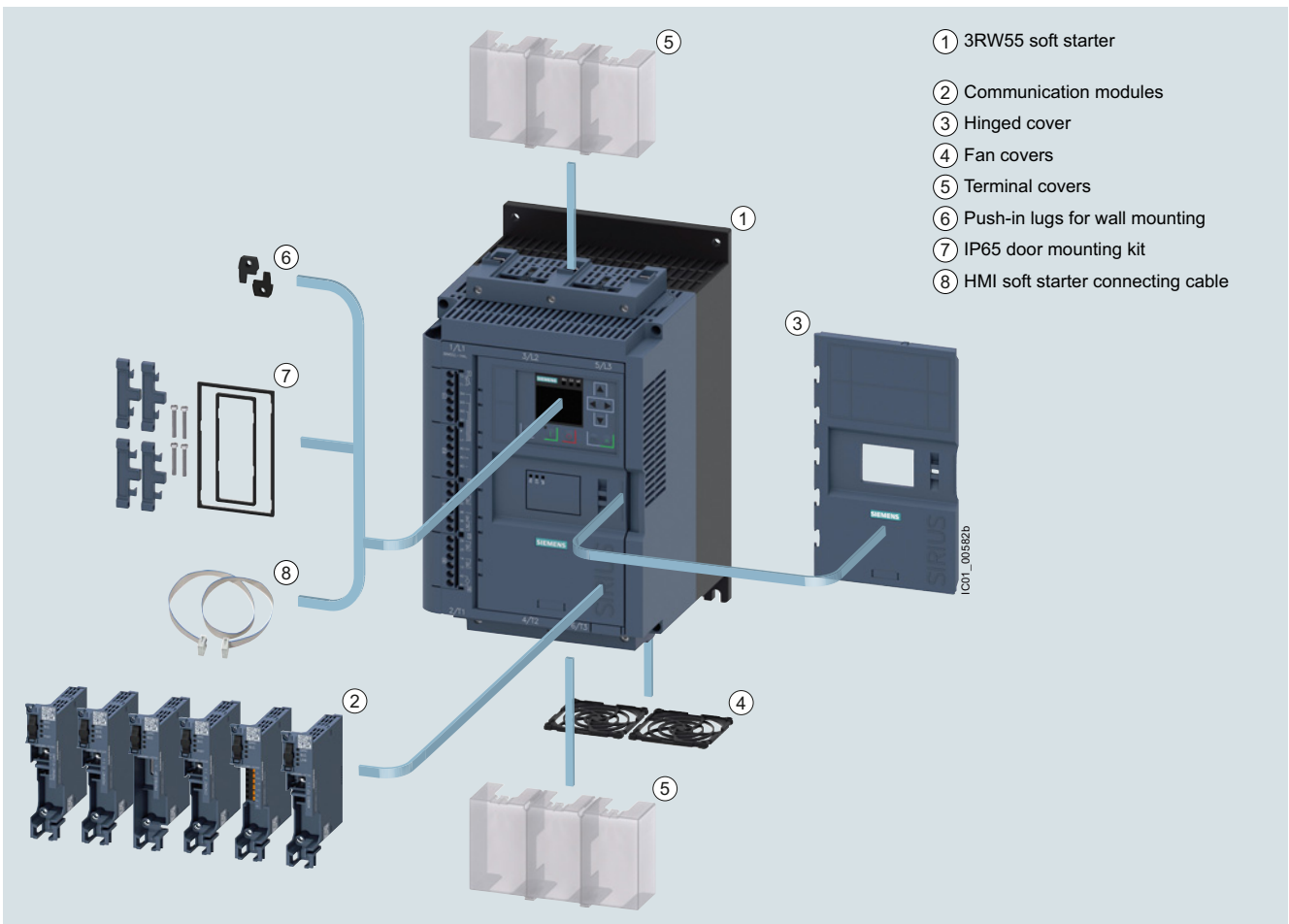

- ① 3RW55 soft starter
- ② Communication modules
- ③ Hinged cover
- ④ Fan covers
- ⑤ Terminal covers
- ⑥ Push-in lugs for wall mounting
- ⑦ IP65 door mounting kit
- ⑧ HMI soft starter connecting cable

SIRIUS 3RW55 High Performance soft starter with accessories (see page 6/36)

Switching devices – Soft starters and solid-state switching devices

SIRIUS 3RW soft starters
High Performance soft starters

3RW55 soft starters > General data

Benefits

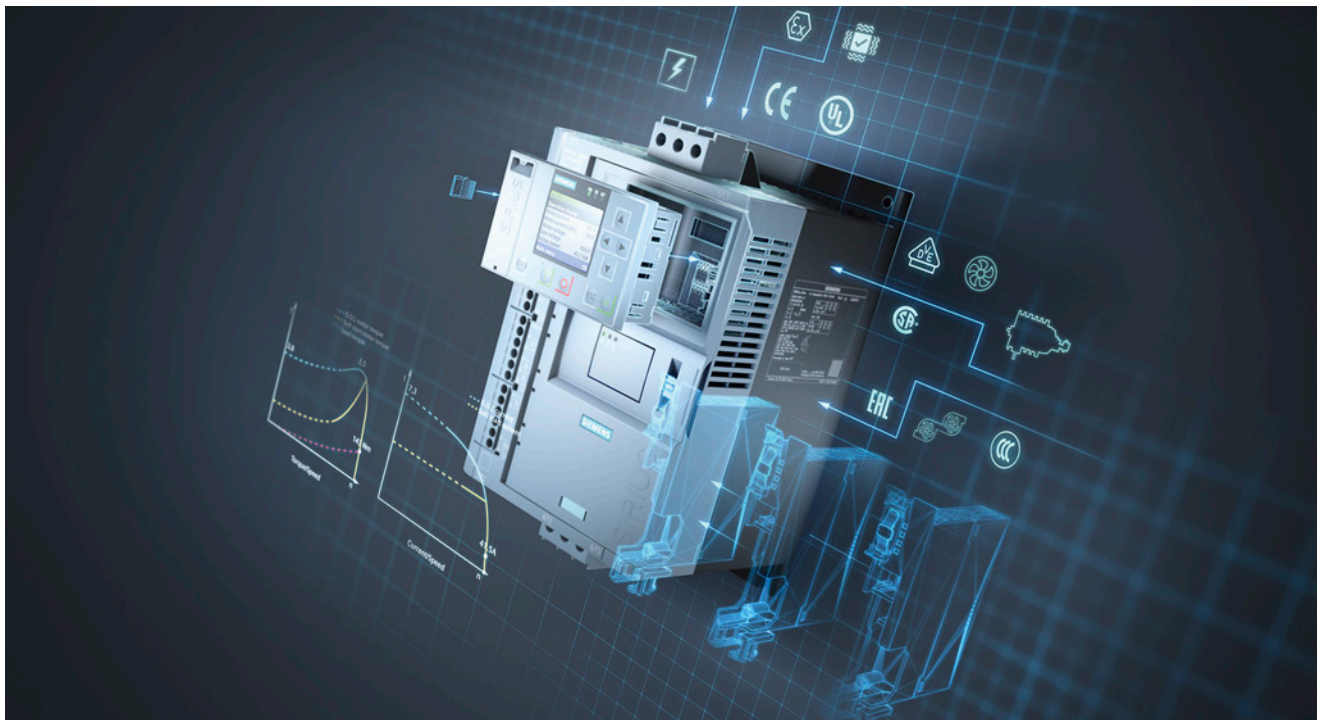

Product characteristics / function	Performance features / benefits
Automatic parameterization	Extremely easy commissioning and reliability even under changing load conditions
Hybrid switching technology and 3-phase motor control	Minimum power loss and optimum/symmetrical motor control
Integration into TIA Portal – communication modules optional	Efficient configuration and maximum flexibility in automation engineering
Removable HMI with color display, local interface, slot for micro SD memory card	Maximum flexibility with regard to user interface and intuitive menu guidance
Pump stop and torque control	Reduced mechanical loading and optimum pump stop control
Certified according to ATEX/IECEX directive	Suitable for the starting of explosion-proof motors

Switching devices – Soft starters and solid-state switching devices

SIRIUS 3RW soft starters

High Performance soft starters

3RW55 soft starters > General data

Technical specifications

More information

Technical specifications, see
<https://support.industry.siemens.com/cs/ww/en/ps/25099/td>
 Equipment Manual, see
<https://support.industry.siemens.com/cs/ww/en/view/109753752>

FAQs, see <https://support.industry.siemens.com/cs/ww/en/ps/25099/faq>
 Simulation Tool for Soft Starters (STS), see page 6/9 or
<https://support.industry.siemens.com/cs/ww/en/view/101494917>

Type	3RW551.-.HA.4 3RW551.-.HA.5	3RW552.-.HA.6 3RW553.-.HA.6	3RW552.-.HA.4 3RW553.-.HA.4	3RW554.-.HA.4	3RW554.-.HA.6	3RW555.-.HA.4	3RW555.-.HA.6
Installation/fixing/dimensions							
Width x height x depth mm	170 x 275 x 152	185 x 306 x 203		210 x 393 x 203			478 x 764 x 241
Type of mounting	Screw fixing						
Mounting position	Vertical (can be rotated +/- 90° and tilted +/- 22.5° forward or backward)						
Distance to be maintained with side-by-side mounting							
• Above	mm	100					
• At the side	mm	5					
• Below	mm	75					
Maximum installation altitude above sea level¹⁾ m	5 000	2 000	5 000		2 000	5 000	2 000
Degree of protection IP on the front acc. to IEC 60529	IP20	IP00 (IP20 with cover)				IP00	
Touch protection on the front acc. to IEC 60529	Finger-safe for vertical touching from the front	Finger-safe for vertical touching from the front with cover				--	
Ambient conditions							
Ambient temperature							
• During operation ²⁾	°C	-25 ... +60					
• During storage and transport	°C	-40 ... +80					
Environmental category according to IEC 60721							
• During operation		3K6 (no ice formation, only occasional condensation), 3C3 (no salt mist), 3S2 (sand must not get into the devices), 3M6					
• During storage		1K6 (only occasional condensation), 1C2 (no salt mist), 1S2 (sand must not get into the devices), 1M4					
• During transport		2K2, 2C1, 2S1, 2M2 (max. height of fall 0.3 m)					

¹⁾ Derating from 1 000 m, see [characteristic curve on page 6/8](#).

²⁾ Note derating above 40 °C.

Switching devices – Soft starters and solid-state switching devices

SIRIUS 3RW soft starters High Performance soft starters

3RW55 soft starters > General data

Type		3RW55...-HA0.	3RW55...-HA1.
Control circuit/control			
Control supply voltage			
• At AC/DC	V	24/24	--/--
• At AC	V	--	110 ... 250
• Relative negative tolerance/relative positive tolerance with AC	%	-20/20	-15/10
• Relative negative tolerance/relative positive tolerance with DC	%	-20/20	--/--
Frequency of the control supply voltage			
• Relative negative tolerance/relative positive tolerance	Hz	50 ... 60	
• Relative negative tolerance/relative positive tolerance	%	-10/10	
Type of overvoltage protection			
Varistors			
Type of short-circuit protection for control circuit¹⁾			
Fuse 4 A gG ($I_{cu} = 1 \text{ kA}$), fuse 6 A quick-response ($I_{cu} = 1 \text{ kA}$), MCB C1 ($I_{cu} = 600 \text{ A}$), MCB C6 ($I_{cu} = 300 \text{ A}$)			

¹⁾ Not included in scope of supply.

Type		3RW55...-HA.4	3RW55...-HA.5	3RW55...-HA.6
Power electronics				
Operational voltage, rated value				
• Relative negative tolerance/relative positive tolerance	V	200 ... 480	200 ... 600	200 ... 690
• Relative negative tolerance/relative positive tolerance	%	-15/10		
Operational voltage for inside-delta circuit, rated value				
• Relative negative tolerance/relative positive tolerance	V	200 ... 480	200 ... 600	
• Relative negative tolerance/relative positive tolerance	%	-15/10		
Operating frequency				
• Relative negative tolerance/relative positive tolerance	Hz	50 ... 60		
• Relative negative tolerance/relative positive tolerance	%	-10/10		
Minimum load [% of I_M]¹⁾				
%				
Maximum cable length between soft starter and motor				
m				

¹⁾ Relative to set I_e .

Switching devices – Soft starters and solid-state switching devices

SIRIUS 3RW soft starters

High Performance soft starters

3RW55 soft starters > General data

Type		3RW5513	3RW5514	3RW5515	3RW5516	3RW5517
Rated operational current I_e	A	13	18	25	32	38
Power electronics						
Load rating with rated operational current I_e						
IEC + UL/CSA, individual mounting at 40/50/60 °C, A AC-53a		13/11.5/10.5	18/15.9/13.8	25/22.3/19.6	32/28.4/26	38/33.5/30.5
Permissible rated motor current and starts/h						
Normal starting (CLASS 10A)						
Rated motor current I_M , $T_u = 40/50/60$ °C ON period = 70%; motor protection activated	A	13/11.5/10.5	18/15.9/13.8	25/22.3/19.6	32/28.4/26	38/33.5/30.5
• 300% I_M						
- Start-up time 5 s	1/h	43	43	43	43	43
- Start-up time 10 s	1/h	18	18	18	18	18
• 350% I_M						
- Start-up time 5 s	1/h	28	28	28	28	28
- Start-up time 10 s	1/h	10	10	10	10	10
Normal starting (CLASS 10E)						
Rated motor current I_M , $T_u = 40/50/60$ °C ON period = 70%; motor protection activated	A	13/11.5/10.5	18/15.9/13.8	25/22.3/19.6	32/28.4/26	38/33.5/30.5
• 300% I_M						
- Start-up time 10 s	1/h	21	21	21	21	21
- Start-up time 20 s	1/h	8	8	8	8	8
• 350% I_M						
- Start-up time 10 s	1/h	13	13	13	13	13
- Start-up time 20 s	1/h	4	4	4	4	4
Heavy starting (CLASS 20E)						
Rated motor current I_M , $T_u = 40/50/60$ °C ON period = 70%; motor protection activated	A	13/11.5/10.5	18/15.9/13.8	25/22.3/19.6	29.6/27.2/23.6	33.5/30.5/27.5
• 300% I_M						
- Start-up time 20 s	1/h	10	10	10	10	10
- Start-up time 40 s	1/h	4	4	4	4	4
• 350% I_M						
- Start-up time 20 s	1/h	7	7	7	7	7
- Start-up time 40 s	1/h	2.5	2.5	2.5	2.5	2.5
Heavy starting (CLASS 30E)						
Rated motor current I_M , $T_u = 40/50/60$ °C ON period = 70%; motor protection activated	A	13/11.5/10.5	18/15.9/13.8	25/22.3/19.6	26/23.6/21.2	29/26/23
• 300% I_M						
- Start-up time 30 s	1/h	7	7	7	7	7
- Start-up time 60 s	1/h	3	3	3	3	3
• 350% I_M						
- Start-up time 30 s	1/h	4	4	4	4	4
- Start-up time 60 s	1/h	1.8	1.8	1.8	1.8	1.8
Adjustable rated motor current I_M						
• Minimum/maximum	A	2.5/13	3.5/18	5/25	6.5/32	7.5/38
• Minimum/maximum in inside-delta circuits	A	4.3/22.5	6.1/31.1	8.7/43.3	11.3/55.4	13/65.8

Switching devices – Soft starters and solid-state switching devices

SIRIUS 3RW soft starters

High Performance soft starters

3RW55 soft starters > General data

Type		3RW5521	3RW5524	3RW5525	3RW5526	3RW5527
Rated operational current I_e	A	25	47	63	77	93
Power electronics						
Load rating with rated operational current I_e						
IEC + UL/CSA, individual mounting at 40/50/60 °C, A AC-53a						
		25/22.3/19.6	47/41.6/36.2	63/55.5/50.5	77/68/62	93/82.5/75.5
Permissible rated motor current and starts/h						
Normal starting (CLASS 10A)						
Rated motor current I_M , $T_u = 40/50/60$ °C ON period = 70%; motor protection activated						
	A	25/22.3/19.6	47/41.6/36.2	63/55.5/50.5	77/68/62	93/82.5/75.5
• 300% I_M						
- Start-up time 5 s	1/h	43	43	43	43	43
- Start-up time 10 s	1/h	18	18	18	18	18
• 350% I_M						
- Start-up time 5 s	1/h	28	28	28	28	28
- Start-up time 10 s	1/h	10	10	10	10	10
Normal starting (CLASS 10E)						
Rated motor current I_M , $T_u = 40/50/60$ °C ON period = 70%; motor protection activated						
	A	25/22.3/19.6	47/41.6/36.2	63/55.5/50.5	77/68/62	93/82.5/75.5
• 300% I_M						
- Start-up time 10 s	1/h	21	21	21	21	21
- Start-up time 20 s	1/h	8	8	8	8	8
• 350% I_M						
- Start-up time 10 s	1/h	13	13	13	13	13
- Start-up time 20 s	1/h	4	4	4	4	4
Heavy starting (CLASS 20E)						
Rated motor current I_M , $T_u = 40/50/60$ °C ON period = 70%; motor protection activated						
	A	25/22.3/19.6	47/41.6/36.2	63/55.5/50.5	77/68/62	93/82.5/75.5
• 300% I_M						
- Start-up time 20 s	1/h	10	10	10	10	10
- Start-up time 40 s	1/h	4	4	4	4	4
• 350% I_M						
- Start-up time 20 s	1/h	7	7	7	7	7
- Start-up time 40 s	1/h	2.5	2.5	2.5	2.5	2.5
Heavy starting (CLASS 30E)						
Rated motor current I_M , $T_u = 40/50/60$ °C ON period = 70%; motor protection activated						
	A	25/22.3/19.6	43.4/38/34.4	53/48/43	68/62/56	82.5/75.5/65
• 300% I_M						
- Start-up time 30 s	1/h	7	7	7	7	7
- Start-up time 60 s	1/h	3	3	3	3	3
• 350% I_M						
- Start-up time 30 s	1/h	4	4	4	4	4
- Start-up time 60 s	1/h	1.8	1.8	1.8	1.8	1.8
Adjustable rated motor current I_M						
• Minimum/maximum	A	5/25	10/47	13/63	16/77	19/93
• Minimum/maximum in inside-delta circuits	A	8.7/43.3	17.3/81.4	22.5/109	27.7/133	32.9/161

Switching devices – Soft starters and solid-state switching devices

SIRIUS 3RW soft starters

High Performance soft starters

3RW55 soft starters > General data

Type		3RW5534	3RW5535	3RW5536
Rated operational current I_e	A	113	143	171
Power electronics				
Load rating with rated operational current I_e				
IEC + UL/CSA, individual mounting at 40/50/60 °C, AC-53a	A	113/101/89	143/128/118	171/153/141
Permissible rated motor current and starts/h				
Normal starting (CLASS 10A)				
Rated motor current I_M , $T_u = 40/50/60$ °C ON period = 70%; motor protection activated	A	113/101/89	143/128/118	171/153/141
• 300% I_M				
- Start-up time 5 s	1/h	43	43	43
- Start-up time 10 s	1/h	18	18	18
• 350% I_M				
- Start-up time 5 s	1/h	28	28	28
- Start-up time 10 s	1/h	10	10	10
Normal starting (CLASS 10E)				
Rated motor current I_M , $T_u = 40/50/60$ °C ON period = 70%; motor protection activated	A	113/101/89	143/128/118	171/153/141
• 300% I_M				
- Start-up time 10 s	1/h	21	21	21
- Start-up time 20 s	1/h	8	8	8
• 350% I_M				
- Start-up time 10 s	1/h	13	13	13
- Start-up time 20 s	1/h	4	4	4
Heavy starting (CLASS 20E)				
Rated motor current I_M , $T_u = 40/50/60$ °C ON period = 70%; motor protection activated	A	109/97/85	128/113/103	141/129/117
• 300% I_M				
- Start-up time 20 s	1/h	10	10	10
- Start-up time 40 s	1/h	4	4	4
• 350% I_M				
- Start-up time 20 s	1/h	7	7	7
- Start-up time 40 s	1/h	2.5	2.5	2.5
Heavy starting (CLASS 30E)				
Rated motor current I_M , $T_u = 40/50/60$ °C ON period = 70%; motor protection activated	A	89/81/74	108/98/88	117/105/93
• 300% I_M				
- Start-up time 30 s	1/h	7	7	7
- Start-up time 60 s	1/h	3	3	3
• 350% I_M				
- Start-up time 30 s	1/h	4	4	4
- Start-up time 60 s	1/h	1.8	1.8	1.8
Adjustable rated motor current I_M				
• Minimum/maximum	A	23/113	29/143	34/171
• Minimum/maximum in inside-delta circuits	A	39.8/195	50.2/247	58.9/296

Switching devices – Soft starters and solid-state switching devices

SIRIUS 3RW soft starters

High Performance soft starters

3RW55 soft starters > General data

Type		3RW5543	3RW5544	3RW5545	3RW5546	3RW5547	3RW5548
Rated operational current I_e	A	210	250	315	370	470	570
Power electronics							
Load rating with rated operational current I_e							
IEC + UL/CSA, individual mounting at 40/50/60 °C, AC-53a	A	210/186/170	250/220/200	315/279/255	370/328/300	470/416/380	570/504/460
Permissible rated motor current and starts/h							
Normal starting (CLASS 10A)							
Rated motor current I_M , $T_u = 40/50/60$ °C ON period = 70%; motor protection activated	A	210/186/170	250/220/200	315/279/255	370/328/300	470/416/380	570/504/460
• 300% I_M							
- Start-up time 5 s	1/h	43	43	43	43	40	20
- Start-up time 10 s	1/h	18	18	18	18	17	6
• 350% I_M							
- Start-up time 5 s	1/h	28	28	28	28	26	9
- Start-up time 10 s	1/h	10	10	10	10	10	1
Normal starting (CLASS 10E)							
Rated motor current I_M , $T_u = 40/50/60$ °C ON period = 70%; motor protection activated	A	210/186/170	250/220/200	315/279/255	370/328/300	470/416/380	551/490/445
• 300% I_M							
- Start-up time 10 s	1/h	21	21	21	21	17	8
- Start-up time 20 s	1/h	8	8	8	8	6	1
• 350% I_M							
- Start-up time 10 s	1/h	13	13	13	13	10	2
- Start-up time 20 s	1/h	4	4	4	4	2	--
Heavy starting (CLASS 20E)							
Rated motor current I_M , $T_u = 40/50/60$ °C ON period = 70%; motor protection activated	A	162/146/130	200/180/160	231/207/183	258/230/202	272/254/236	284/262/240
• 300% I_M							
- Start-up time 20 s	1/h	10	10	10	10	10	10
- Start-up time 40 s	1/h	4	4	4	4	4	4
• 350% I_M							
- Start-up time 20 s	1/h	7	7	7	7	7	7
- Start-up time 40 s	1/h	2.5	2.5	2.5	2.5	2.5	2.5
Heavy starting (CLASS 30E)							
Rated motor current I_M , $T_u = 40/50/60$ °C ON period = 70%; motor protection activated	A	138/122/106	160/140/120	183/159/135	202/174/160	210/190/170	220/200/180
• 300% I_M							
- Start-up time 30 s	1/h	7	7	7	7	7	7
- Start-up time 60 s	1/h	3	3	3	3	3	3
• 350% I_M							
- Start-up time 30 s	1/h	4	4	4	4	4	4
- Start-up time 60 s	1/h	1.8	1.8	1.8	1.8	1.8	1.8
Adjustable rated motor current I_M							
• Minimum/maximum	A	42/210	50/250	63/315	74/370	94/470	114/570
• Minimum/maximum in inside-delta circuits	A	72.7/363	86.6/433	109.1/545	128.2/640	162.8/814	197.5/987

Switching devices – Soft starters and solid-state switching devices

SIRIUS 3RW soft starters

High Performance soft starters

3RW55 soft starters > General data

Type		3RW5552	3RW5553	3RW5554	3RW5556	3RW5558
Rated operational current I_e	A	630	720	840	1 100	1 280
Power electronics						
Load rating with rated operational current I_e						
IEC + UL/CSA, individual mounting at 40/50/60 °C, A AC-53a						
630/561/510						
720/641/580						
840/748/670						
1 100/979/890						
1 280/1 139/1 030						
Permissible rated motor current and starts/h						
Normal starting (CLASS 10A)						
Rated motor current I_M , $T_u = 40/50/60$ °C						
ON period = 70%; motor protection activated						
A						
630/561/510						
720/641/580						
840/748/670						
1 100/979/890						
1 280/1 139/1 030						
• 300% I_M						
- Start-up time 5 s						
1/h						
43						
43						
42						
43						
32						
- Start-up time 10 s						
1/h						
18						
18						
18						
18						
12						
• 350% I_M						
- Start-up time 5 s						
1/h						
28						
28						
25						
27						
17						
- Start-up time 10 s						
1/h						
10						
10						
10						
9						
4						
Normal starting (CLASS 10E)						
Rated motor current I_M , $T_u = 40/50/60$ °C						
ON period = 70%; motor protection activated						
A						
630/561/510						
720/641/580						
840/748/670						
1 100/979/890						
1 225/1 130/1 030						
• 300% I_M						
- Start-up time 10 s						
1/h						
21						
21						
19						
18						
15						
- Start-up time 20 s						
1/h						
8						
8						
7						
7						
5						
• 350% I_M						
- Start-up time 10 s						
1/h						
13						
13						
10						
9						
1						
- Start-up time 20 s						
1/h						
4						
4						
2						
2						
1						
Heavy starting (CLASS 20E)						
Rated motor current I_M , $T_u = 40/50/60$ °C						
ON period = 70%; motor protection activated						
A						
500/450/400						
520/470/420						
570/520/470						
920/840/760						
980/900/810						
• 300% I_M						
- Start-up time 20 s						
1/h						
10						
10						
10						
10						
10						
- Start-up time 40 s						
1/h						
4						
4						
4						
4						
4						
• 350% I_M						
- Start-up time 20 s						
1/h						
7						
7						
7						
7						
7						
- Start-up time 40 s						
1/h						
2.5						
2.5						
2.5						
2.5						
2.5						
Heavy starting (CLASS 30E)						
Rated motor current I_M , $T_u = 40/50/60$ °C						
ON period = 70%; motor protection activated						
A						
380/340/300						
400/360/320						
420/380/340						
740/670/600						
790/720/650						
• 300% I_M						
- Start-up time 30 s						
1/h						
7						
7						
7						
7						
7						
- Start-up time 60 s						
1/h						
3						
3						
3						
3						
3						
• 350% I_M						
- Start-up time 30 s						
1/h						
4						
4						
4						
4						
4						
- Start-up time 60 s						
1/h						
1.8						
1.8						
1.8						
1.8						
1.8						
Adjustable rated motor current I_M						
• Minimum/maximum						
A						
114/630						
144/720						
168/840						
220/1 100						
258/1 280						
• Minimum/maximum in inside-delta circuits						
A						
197.5/987						
249.4/1 247						
291/1 454						
381.1/1 905						
446.9/2 217						

Switching devices – Soft starters and solid-state switching devices

SIRIUS 3RW soft starters
High Performance soft starters

3RW55 soft starters > General data

**Motor feeders according to IEC with 3RV2 motor starter protectors or 3VA circuit breakers
(without semiconductor protection)**

Type of coordination "1", CLASS 10,
short-circuit breaking capacity I_q in kA, [see table](#)

Note:

For general recommendations for constructing motor feeders
with soft starters, [see page 6/11](#).

Soft starters	Motor starter protectors				Motor starter protectors			
	for 400 V systems		for 500 V systems		for 400 V systems		for 500 V systems	
Q11 Type	Q1 Type	I_q kA	Q1 Type	I_q kA	Q1 Type	I_q kA	Q1 Type	I_q kA
Type of coordination "1" <small>ToC 1</small>	Inline circuit				Inside-delta circuit			
3RW5513	3RV2032-4TA10	65	3RV2032-4TA10	18	3RV2032-4DA10	65	3RV2032-4DA10	18
3RW5514	3RV2032-4DA10	65	3RV2032-4DA10	15	3RV2032-4EA10	65	3RV2032-4EA10	15
3RW5515	3RV2032-4EA10	65	3RV2032-4EA10	15	3RV2032-4VA10	65	3RV2032-4VA10	15
3RW5516	3RV2032-4VA10	65	3RV2032-4VA10	10	3RV2032-4JA10	65	3RV2032-4JA10	10
3RW5517	3RV2032-4WA10	65	3RV2032-4WA10	10	3RV2032-4RA10	65	3RV2032-4RA10	10
3RW5521	--	--	--	--	--	--	--	--
3RW5522	3RV2032-4JA10	65	3RV2032-4JA10	10	3RV2032-4RA10	65	3RV2032-4RA10	10
3RW5525	3VA2163-7MN32-0AA0	65	3VA2163-7MN32-0AA0	20	3VA2110-7MN32-0AA0	65	3VA2110-7MN32-0AA0	20
3RW5526	3VA2110-7MN32-0AA0	65	3VA2110-7MN32-0AA0	20	3VA2216-7MN32-0AA0	65	3VA2216-7MN32-0AA0	20
3RW5527	3VA2216-7MN32-0AA0	15	3VA2216-7MN32-0AA0	10	3VA2220-7MN32-0AA0	15	3VA2220-7MN32-0AA0	10
3RW5534	3VA2216-7MN32-0AA0	65	--	--	3VA2220-7MN32-0AA0	65	--	--
3RW5535	3VA2220-7MN32-0AA0	65	--	--	3VA2325-7MN32-0AA0	65	--	--
3RW5536	3VA2325-7MN32-0AA0	30	3VA2325-7MN32-0AA0	10	3VA2440-7MN32-0AA0	30	3VA2440-7MN32-0AA0	10
3RW5543	3VA2325-7MN32-0AA0	65	3VA2325-7MN32-0AA0	65	3VA2440-7MN32-0AA0	65	3VA2440-7MN32-0AA0	65
3RW5544	3VA2440-7MN32-0AA0	65	3VA2440-7MN32-0AA0	65	3VA2450-7MN32-0AA0	65	3VA2450-7MN32-0AA0	65
3RW5545	3VA2440-7MN32-0AA0	65	3VA2440-7MN32-0AA0	65	3VA2580-6HN32-0AA0	65	3VA2580-6HN32-0AA0	65
3RW5546	3VA2440-7MN32-0AA0	65	3VA2440-7MN32-0AA0	65	3VA2580-6HN32-0AA0	65	3VA2580-6HN32-0AA0	65
3RW5547	3VA2450-7MN32-0AA0	65	3VA2450-7MN32-0AA0	65	3VA2510-6HN32-0AA0	65	3VA2510-6HN32-0AA0	65
3RW5548	3VA2580-6HN32-0AA0	65	3VA2580-6HN32-0AA0	65	3VA2510-6HN32-0AA0	65	3VA2510-6HN32-0AA0	65
3RW5552	3VA2580-6HN32-0AA0	65	3VA2580-6HN32-0AA0	65	3VA2716-7AB05-0AA0	65	3VA2716-7AB05-0AA0	65
3RW5553	3VA2510-6HN32-0AA0	65	3VA2510-6HN32-0AA0	65	3VA2716-7AB05-0AA0	65	3VA2716-7AB05-0AA0	65
3RW5554	3VA2510-6HN32-0AA0	65	3VA2510-6HN32-0AA0	65	3VA2716-7AB05-0AA0	65	3VA2716-7AB05-0AA0	65
3RW5556	3VA2716-7AB05-0AA0	65	3VA2716-7AB05-0AA0	65	--	--	--	--
3RW5558	3VA2716-7AB05-0AA0	65	3VA2716-7AB05-0AA0	65	--	--	--	--

Note:

The service factor and measurement inaccuracies, for example, have been taken into account for the selection of the specified motor starter protectors/circuit breakers; the specified short-circuit breaking capacities I_q in kA are covered by combination tests. Smaller motor starter protectors/circuit breakers from the same series can be used at any time as smaller ones trip more quickly in the event of a short circuit (unchanged short-circuit breaking capacity) and thus protect the soft starter in any case. The dimensioning of the short-circuit components must match the connected three-phase motor, the short-circuit and overload requirements of the application, and the line protection for the cables used.

When using braking functions, the use of fuses is recommended to avoid the risk of false tripping of 3VA circuit breakers with electronic motor protection function during braking.

In motor feeder tests with soft starters conducted in 690 V systems, demonstrable short-circuit breaking capacities could only be achieved using fuses ($I_q > 5$ to 10 kA).

Switching devices – Soft starters and solid-state switching devices

SIRIUS 3RW soft starters

High Performance soft starters

3RW55 soft starters > General data

Motor feeders according to IEC with 3NA3 fuses

gG class full-range fuses for cable and line protection according to IEC 60269-2, without semiconductor protection

Type of coordination "1",
short-circuit breaking capacity $I_{q} = 65 \text{ kA}$

Note:

For general recommendations for constructing motor feeders with soft starters, see page 6/11.

Soft starters	gG class fuse			Line contactor (optional)		gG class fuse			Line contactor (optional)	
	for systems up to 690 V	for systems up to 480 V	for systems up to 690 V	for systems up to 480 V in the supply cable	for systems up to 600 V in the supply cable	for systems up to 480 V in the delta	for systems up to 600 V in the delta	for systems up to 480 V in the delta	for systems up to 600 V in the delta	
Q11 Type	F1 Type	Q21 Type	Q21 Type	F1 Type	Q21 Type	Q21 Type	Q21 Type	Q21 Type	Q21 Type	
Type of coordination "1"	Inline circuit			Inside-delta circuit						
3RW5513	3NA3820-6	3RT2025	3RT2025	3NA3820-6	3RT2027	3RT2035	3RT2025	3RT2025	3RT2025	
3RW5514	3NA3820-6	3RT2026	3RT2027	3NA3820-6	3RT2027	3RT2037	3RT2026	3RT2027	3RT2027	
3RW5515	3NA3822-6	3RT2027	3RT2037	3NA3822-6	3RT2036	3RT2037	3RT2027	3RT2037	3RT2037	
3RW5516	3NA3824-6	3RT2035	3RT2037	3NA3824-6	3RT2037	3RT2038	3RT2035	3RT2037	3RT2037	
3RW5517	3NA3824-6	3RT2035	3RT2037	3NA3824-6	3RT2038	3RT2046	3RT2035	3RT2037	3RT2037	
3RW5521	3NA3824-6	3RT2027	3RT2037	3NA3824-6	3RT2036	3RT2037	3RT2027	3RT2037	3RT2037	
3RW5524	3NA3824-6	3RT2036	3RT2037	3NA3824-6	3RT2046	3RT2047	3RT2036	3RT2037	3RT2037	
3RW5525	3NA3830-6	3RT2037	3RT2046	3NA3830-6	3RT2047	3RT1054	3RT2037	3RT2046	3RT2046	
3RW5526	3NA3132-6	3RT2038	3RT2046	3NA3132-6	3RT1055	3RT1055	3RT2038	3RT2046	3RT2046	
3RW5527	3NA3136-6	3RT2046	3RT2047	3NA3136-6	3RT1056	3RT1056	3RT2046	3RT2047	3RT2047	
3RW5534	3NA3244-6	3RT1054	3RT1054	3NA3244-6	3RT1064	3RT1064	3RT1054	3RT1054	3RT1054	
3RW5535	3NA3244-6	3RT1055	3RT1055	3NA3244-6	3RT1065	3RT1065	3RT1055	3RT1055	3RT1055	
3RW5536	3NA3365-6	3RT1056	3RT1064	3NA3365-6	3RT1066	3RT1075	3RT1056	3RT1064	3RT1064	
3RW5543	2 x 3NA3354-6	3RT1064	3RT1064	2 x 3NA3354-6	3RT1075	3RT1075	3RT1064	3RT1064	3RT1064	
3RW5544	2 x 3NA3354-6	3RT1065	3RT1065	2 x 3NA3354-6	3RT1076	3RT1076	3RT1065	3RT1065	3RT1065	
3RW5545	2 x 3NA3365-6	3RT1075	3RT1075	2 x 3NA3365-6	3TF68	3TF68	3RT1075	3RT1075	3RT1075	
3RW5546	2 x 3NA3365-6	3RT1075	3RT1075	2 x 3NA3365-6	3TF69	3TF69	3RT1075	3RT1075	3RT1075	
3RW5547	2 x 3NA3365-6	3RT1076	3RT1276	2 x 3NA3365-6	3TF69	3TF69	3RT1076	3RT1276	3RT1276	
3RW5548	2 x 3NA3365-6	3TF68	3TF68	2 x 3NA3365-6	--	--	3TF68	3TF68	3TF68	
3RW5552	2 x 3NA3365-6	3TF68	3TF69	--	--	--	3TF68	3TF69	3TF69	
3RW5553	2 x 3NA3365-6	3TF69	3TF69	--	--	--	3TF69	3TF69	3TF69	
3RW5554	2 x 3NA3365-6	--	--	--	--	--	--	--	--	
3RW5556	3 x 3NA3365-6	--	--	--	--	--	--	--	--	
3RW5558	3 x 3NA3365-6	--	--	--	--	--	--	--	--	

Note:

The specified short-circuit breaking capacities I_{q} in kA are covered by combination tests. Smaller fuses than those specified can be used at any time as smaller ones trip more quickly in the event of a short circuit (unchanged short-circuit breaking capacity) and thus protect the soft starter in any case. The dimensioning of the short-circuit components must, however, be suitable for the connected three-phase motor and the line protection for the cables used.

In inside-delta circuits, motor feeders with soft starters can only be operated in systems with up to 600 V.

Switching devices – Soft starters and solid-state switching devices

SIRIUS 3RW soft starters
High Performance soft starters

3RW55 soft starters > General data

Motor feeders according to IEC with 3NE1/3NB3 SITOP fusesgR class full-range fuses for semiconductor protection,
cable and line protectionType of coordination "2",
short-circuit breaking capacity $I_{q} = 65 \text{ kA}$

Note:

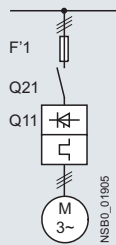
For general recommendations for constructing motor feeders
with soft starters, [see page 6/11](#).

Soft starters	gR class fuse	Line contactor (optional)	
Q11	for systems up to 690 V	for systems up to 480 V	for systems up to 690 V
Type	F'1	Q21	Q21
Type	Type	Type	Type
Type of coordination "2"	Inline circuit ToC 2		
3RW5513	3NE 1815-0	3RT2025	3RT2025
3RW5514	3NE 1802-0	3RT2026	3RT2027
3RW5515	3NE 1817-0	3RT2027	3RT2037
3RW5516	3NE 1818-0	3RT2035	3RT2037
3RW5517	3NE 1820-0	3RT2035	3RT2037
3RW5521	3NE 1817-0	3RT2027	3RT2037
3RW5524	3NE 1021-2	3RT2036	3RT2037
3RW5525	3NE 1022-0	3RT2037	3RT2046
3RW5526	3NE 1224-0	3RT2038	3RT2046
3RW5527	3NE 1224-0	3RT2046	3RT2047
3RW5534	3NE 1225-0	3RT1054	3RT1054
3RW5535	3NE 1227-0	3RT1055	3RT1055
3RW5536	3NE 1230-0	3RT1056	3RT1064
3RW5543	3NE 1230-2 ¹⁾	3RT1064	3RT1064
3RW5544	3NE 1331-0	3RT1065	3RT1065
3RW5545	3NE 1334-2	3RT1075	3RT1075
3RW5546	3NE 1334-2	3RT1075	3RT1075
3RW5547	3NE 1436-2	3RT1076	3RT1276
3RW5548	3NE 1437-2	3TF68	3TF68
3RW5552	3NB3350-1KK26	3TF68	3TF69
3RW5553	3NB3351-1KK26	3TF69	3TF69
3RW5554	3NB3351-1KK26	--	--
3RW5556	3NB3354-1KK26	--	--
3RW5558	3NB3357-1KK26	--	--

¹⁾ For systems up to 500 V.

Note:

The specified short-circuit breaking capacities I_{q} in kA are covered by combination tests. Smaller fuses than those specified can be used at any time as smaller ones trip more quickly in the event of a short circuit (unchanged short-circuit breaking capacity) and thus protect the soft starter in any case. The dimensioning of the short-circuit components must, however, be suitable for the connected three-phase motor and the line protection for the cables used.

In inside-delta circuits, a gR class full-range fuse could not provide the semiconductor protection of the delta-connected soft starter with a short-circuit breaking capacity that is adequate for practical use. In this case, we recommend using aR class partial-range fuses for semiconductor protection for type of coordination "2" ([see page 6/26](#)).

Switching devices – Soft starters and solid-state switching devices

SIRIUS 3RW soft starters

High Performance soft starters

3RW55 soft starters > General data

Motor feeders according to IEC with 3NE8 / 3NE3 / 3NC3 fuses

aR class partial-range fuses for semiconductor protection

Type of coordination "2",
short-circuit breaking capacity $I_{q} = 65 \text{ kA}$

Note:

For general recommendations for constructing motor feeders with soft starters, [see page 6/11](#).

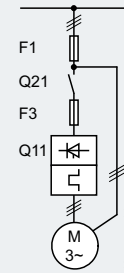
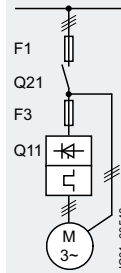
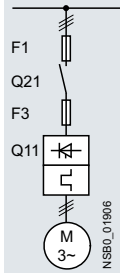

Soft starters	Inline circuit				Inside-delta circuit					
	gG class fuse	aR class fuse	Line contactor (optional)		gG class fuse	aR class fuse	Line contactor (optional)			
	for systems up to 690 V	for systems up to 690 V	for systems up to 480 V	for systems up to 690 V	for systems up to 600 V	for systems up to 600 V	for systems up to 480 V in the supply cable	for systems up to 600 V in the supply cable	for systems up to 480 V in the delta	for systems up to 600 V in the delta
Q11 Type	F1 Type	F3 Type	Q21 Type	Q21 Type	F1 Type	F3 Type	Q21 Type	Q21 Type	Q21 Type	Q21 Type
Type of coordination "2"	Inline circuit				Inside-delta circuit					
3RW5513	3NA3820-6	3NE8017-1	3RT2025	3RT2025	3NA3820-6	3NE8017-1	3RT2027	3RT2035	3RT2025	3RT2025
3RW5514	3NA3820-6	3NE8020-1	3RT2026	3RT2027	3NA3820-6	3NE8020-1	3RT2027	3RT2037	3RT2026	3RT2027
3RW5515	3NA3822-6	3NE8021-1	3RT2027	3RT2037	3NA3822-6	3NE8021-1	3RT2036	3RT2037	3RT2027	3RT2037
3RW5516	3NA3824-6	3NE8022-1	3RT2035	3RT2037	3NA3824-6	3NE8022-1	3RT2037	3RT2038	3RT2035	3RT2037
3RW5517	3NA3824-6	3NE8024-1	3RT2035	3RT2037	3NA3824-6	3NE8024-1	3RT2038	3RT2046	3RT2035	3RT2037
3RW5521	3NA3824-6	3NE8021-1	3RT2027	3RT2037	3NA3824-6	3NE8021-1	3RT2036	3RT2037	3RT2027	3RT2037
3RW5524	3NA3824-6	3NE8024-1	3RT2036	3RT2037	3NA3824-6	3NE8024-1	3RT2046	3RT2047	3RT2036	3RT2037
3RW5525	3NA3830-6	3NE3227	3RT2037	3RT2046	3NA3830-6	3NE3227	3RT2047	3RT1054	3RT2037	3RT2046
3RW5526	3NA3132-6	3NE3227	3RT2038	3RT2046	3NA3132-6	3NE3227	3RT1055	3RT1055	3RT2038	3RT2046
3RW5527	3NA3136-6	3NE3227	3RT2046	3RT2047	3NA3136-6	3NE3227	3RT1056	3RT1056	3RT2046	3RT2047
3RW5534	3NA3244-6	3NE3231	3RT1054	3RT1054	3NA3244-6	3NE3231	3RT1064	3RT1064	3RT1054	3RT1054
3RW5535	3NA3244-6	3NE3233	3RT1055	3RT1055	3NA3244-6	3NE3233	3RT1065	3RT1065	3RT1055	3RT1055
3RW5536	3NA3365-6	3NE3334-0B	3RT1056	3RT1064	3NA3365-6	3NE3334-0B	3RT1066	3RT1075	3RT1056	3RT1064
3RW5543	2 x 3NA3354-6	3NE3333	3RT1064	3RT1064	2 x 3NA3354-6	3NE3333	3RT1075	3RT1075	3RT1064	3RT1064
3RW5544	2 x 3NA3354-6	3NE3335	3RT1065	3RT1065	2 x 3NA3354-6	3NE3335	3RT1076	3RT1076	3RT1065	3RT1065
3RW5545	2 x 3NA3365-6	--	3RT1075	3RT1075	2 x 3NA3365-6	--	3TF68	3TF68	3RT1075	3RT1075
3RW5546	2 x 3NA3365-6	--	3RT1075	3RT1075	2 x 3NA3365-6	--	3TF69	3TF69	3RT1075	3RT1075
3RW5547	2 x 3NA3365-6	3NE3340-8	3RT1076	3RT1276	2 x 3NA3365-6	3NE3340-8	3TF69	3TF69	3RT1076	3RT1276
3RW5548	2 x 3NA3365-6	3NC3342-1U	3TF68	3TF68	2 x 3NA3365-6	3NC3342-1U	--	--	3TF68	3TF68
3RW5552	2 x 3NA3365-6	3NC3343-1U	3TF68	3TF69	--	3NC3343-1U	--	--	3TF68	3TF69
3RW5553	2 x 3NA3365-6	3NC3343-1U	3TF69	3TF69	--	3NC3343-1U	--	--	3TF69	3TF69
3RW5554	2 x 3NA3365-6	3NC3343-1U	--	--	--	3NC3343-1U	--	--	--	--
3RW5556	3 x 3NA3365-6	3 x 3NE3340-8	--	--	--	3 x 3NE3340-8	--	--	--	--
3RW5558	3 x 3NA3365-6	3 x 3NE3340-8	--	--	--	3 x 3NE3340-8	--	--	--	--

Note:

The specified short-circuit breaking capacities I_{q} in kA are covered by combination tests. Smaller fuses than those specified can be used at any time as smaller ones trip more quickly in the event of a short circuit (unchanged short-circuit breaking capacity) and thus protect the soft starter in any case. The dimensioning of the short-circuit components must, however, be suitable for the connected three-phase motor and the line protection for the cables used.

For CLASS 10 applications, as an alternative to the gG class full-range fuses for cable and line protection 3NA3 (F1), 3RV2 motor starter protectors or 3VA circuit breakers can also be used, possibly with reduced short-circuit breaking capacity ([see page 6/23](#)). In these cases, optional line contactors can be dispensed with.

In inside-delta circuits, motor feeders with soft starters can only be operated in systems with up to 600 V.

Switching devices – Soft starters and solid-state switching devices

SIRIUS 3RW soft starters

High Performance soft starters

3RW55 soft starters > General data

Reversing operation with reversing contactors

Note:

For general recommendations for constructing motor feeders with soft starters, [see page 6/11](#).

(For an example circuit, [see 3RW55 Equipment Manual, Appendix A.3](#))

Soft starters	Reversing contactor assembly		For reversing contactor	
	for systems up to 480 V	for systems up to 690 V	for systems up to 480 V	for systems up to 690 V
Q11	Q21 / Q22	Q21 / Q22	Q21 / Q22	Q21 / Q22
Type	Type	Type	Type	Type
3RW5513	3RA2325	3RA2325	3RT2025	3RT2025
3RW5514	3RA2326	3RA2327	3RT2026	3RT2027
3RW5515	3RA2327	3RA2337	3RT2027	3RT2037
3RW5516	3RA2335	3RA2337	3RT2035	3RT2037
3RW5517	3RA2335	3RA2337	3RT2035	3RT2037
3RW5521	3RA2327	3RA2337	3RT2027	3RT2037
3RW5524	3RA2336	3RA2337	3RT2036	3RT2037
3RW5525	3RA2337	3RA2346	3RT2037	3RT2046
3RW5526	3RA2338	3RA2346	3RT2038	3RT2046
3RW5527	3RA2346	3RA2347	3RT2046	3RT2047
3RW5534	--	--	3RT1054	3RT1054
3RW5535	--	--	3RT1055	3RT1055
3RW5536	--	--	3RT1056	3RT1064
3RW5543	--	--	3RT1064	3RT1064
3RW5544	--	--	3RT1065	3RT1065
3RW5545	--	--	3RT1075	3RT1075
3RW5546	--	--	3RT1075	3RT1075
3RW5547	--	--	3RT1076	3RT1276
3RW5548	--	--	3TF68	3TF68
3RW5552	--	--	3TF68	3TF69
3RW5553	--	--	3TF69	3TF69
3RW5554	--	--	--	--
3RW5556	--	--	--	--
3RW5558	--	--	--	--

DC braking with braking contactors

Note:

For general recommendations for constructing motor feeders with soft starters, [see page 6/11](#).

(For an example circuit, [see 3RW55 Equipment Manual, Appendix A.3](#))

Soft starters	DC braking contactor	DC braking contactor assembly		for systems up to 690 V	
	for systems up to 400 V with 2 NC contacts + 2 NO contacts parallel	for systems up to 480 V with 3 NO contacts parallel	with 3 NO contacts parallel	with 3 NO contacts parallel	with 3 NO contacts parallel
Q11	Q93	Q91	Q92	Q91	Q92
Type	Type	Type	Type	Type	Type
3RW5513	3RT2517	3RT2015	3RT2016	3RT2015	3RT2016
3RW5514	3RT2518	3RT2015	3RT2017	3RT2015	3RT2023
3RW5515	3RT2526	3RT2015	3RT2025	3RT2015	3RT2025
3RW5516	3RT2526	3RT2015	3RT2025	3RT2015	3RT2027
3RW5517	3RT2535	3RT2015	3RT2027	3RT2015	3RT2027
3RW5521	3RT2526	3RT2015	3RT2025	3RT2015	3RT2025
3RW5524	3RT2535	3RT2016	3RT2027	3RT2016	3RT2035
3RW5525	--	3RT2024	3RT2027	3RT2024	3RT2037
3RW5526	--	3RT2025	3RT2035	3RT2025	3RT2037
3RW5527	--	3RT2027	3RT2036	3RT2027	3RT2037
3RW5534	--	3RT2035	3RT2037	3RT2035	3RT2038
3RW5535	--	3RT2036	3RT2038	3RT2036	3RT2046
3RW5536	--	3RT2037	3RT2046	3RT2037	3RT2047
3RW5543	--	3RT2045	3RT2047	3RT2045	3RT1054
3RW5544	--	3RT2045	3RT1055	3RT2045	3RT1055
3RW5545	--	3RT2446	3RT1056	3RT2446	3RT1056
3RW5546	--	3RT1055	3RT1056	3RT1055	3RT1064
3RW5547	--	3RT1456	3RT1065	3RT1456	3RT1065
3RW5548	--	3RT1456	3RT1066	3RT1456	3RT1075
3RW5552	--	3RT1065	3RT1075	3RT1065	3RT1075
3RW5553	--	3RT1065	3RT1075	3RT1065	3RT1075
3RW5554	--	3RT1466	3RT1076	3RT1466	3RT1076
3RW5556	--	3RT1476	3TF68	3RT1476	3TF68
3RW5558	--	3RT1476	3TF69	3RT1476	3TF69

Switching devices – Soft starters and solid-state switching devices

SIRIUS 3RW soft starters

High Performance soft starters

3RW55 soft starters > Inline circuit **IE3/IE4 ready**

Selection and ordering data

For normal starting (CLASS 10E)



3RW551.



3RW552.

At 40 °C					At 50 °C					SD ¹⁾	Article No.	Price per PU	PU (UNIT, SET, M)	PS*	PG
Operational current	Operating power for three-phase motors				Operational current	Rating [hp] for three-phase motors									
	At 230 V	At 400 V	At 500 V	At 690 V		At 200/208 V	At 220/230 V	At 460/480 V	At 575/600 V						
A	kW	kW	kW	kW	A	hp	hp	hp	hp	d					
Operational voltage 200 ... 480 V															
13	3	5.5	--	--	11.5	2	3	7.5	--	5	3RW5513-□HA□4		1	1 unit	42S
18	4	7.5	--	--	15.9	3	5	10	--	5	3RW5514-□HA□4		1	1 unit	42S
25	5.5	11	--	--	22.3	5	7.5	15	--	5	3RW5515-□HA□4		1	1 unit	42S
32	7.5	15	--	--	28.4	7.5	10	20	--	5	3RW5516-□HA□4		1	1 unit	42S
38	11	18.5	--	--	33.5	10	10	20	--	5	3RW5517-□HA□4		1	1 unit	42S
47	11	22	--	--	41.6	10	10	30	--	5	3RW5524-□HA□4		1	1 unit	42S
63	18.5	30	--	--	55.5	15	20	40	--	5	3RW5525-□HA□4		1	1 unit	42S
77	22	37	--	--	68	20	25	50	--	5	3RW5526-□HA□4		1	1 unit	42S
93	22	45	--	--	82.5	25	30	60	--	5	3RW5527-□HA□4		1	1 unit	42S

Type of electrical connection for the control circuit

Screw terminals

Spring-loaded terminals

Control supply voltage

24 V AC/DC

110 ... 250 V AC

¹⁾ 3RW55 soft starter with screw terminals for operational voltage up to 480 V: Standard delivery time SD = 1 day (d).

Note:

For the constraints for the motor outputs specified here, see page 6/8.

1
3

0
1

Switching devices – Soft starters and solid-state switching devices

SIRIUS 3RW soft starters

High Performance soft starters

IE3/IE4 ready 3RW55 soft starters > Inline circuit

For normal starting (CLASS 10E)

3RW553.



3RW554.



3RW555.

At 40 °C					At 50 °C					SD ¹⁾	Article No.	Price per PU	PU (UNIT, SET, M)	PS*	PG
Operational current	Operating power for three-phase motors				Operational current	Rating [hp] for three-phase motors									
	At 230 V	At 400 V	At 500 V	At 690 V		At 200/208 V	At 220/230 V	At 460/480 V	At 575/600 V	hp	hp	hp	hp	d	
Operational voltage 200 ... 480 V															
113	30	55	--	--	101	30	30	75	--	5	3RW5534-□HA□4		1	1 unit	42S
143	37	75	--	--	128	40	40	100	--	5	3RW5535-□HA□4		1	1 unit	42S
171	45	90	--	--	153	50	50	100	--	5	3RW5536-□HA□4		1	1 unit	42S
210	55	110	--	--	186	60	60	150	--	5	3RW5543-□HA□4		1	1 unit	42S
250	75	132	--	--	220	60	75	150	--	5	3RW5544-□HA□4		1	1 unit	42S
315	90	160	--	--	279	75	100	200	--	5	3RW5545-□HA□4		1	1 unit	42S
370	110	200	--	--	328	100	125	250	--	5	3RW5546-□HA□4		1	1 unit	42S
470	132	250	--	--	416	150	150	350	--	5	3RW5547-□HA□4		1	1 unit	42S
570	160	315	--	--	504	150	200	400	--	5	3RW5548-□HA□4		1	1 unit	42S
630	200	355	--	--	561	200	200	450	--	15	3RW5552-□HA□4		1	1 unit	42S
720	200	400	--	--	641	200	250	500	--	15	3RW5553-□HA□4		1	1 unit	42S
840	250	450	--	--	748	250	300	600	--	15	3RW5554-□HA□4		1	1 unit	42S
1 100	315	560	--	--	979	350	400	850	--	15	3RW5556-□HA□4		1	1 unit	42S
1 280	400	710	--	--	1 139	400	450	1 000	--	15	3RW5558-□HA□4		1	1 unit	42S

Type of electrical connection for the control circuit

 Spring-loaded terminals
 Screw terminals

Control supply voltage

 24 V AC/DC
 110 ... 250 V AC

¹⁾ 3RW55 soft starter with screw terminals for operational voltage up to 480 V:
 Standard delivery time SD = 1 day (d).

Note:

For the constraints for the motor outputs specified here, see page 6/8.

 2
 6

 0
 1

Switching devices – Soft starters and solid-state switching devices

SIRIUS 3RW soft starters

High Performance soft starters

3RW55 soft starters > Inline circuit **IE3/IE4 ready**

For normal starting (CLASS 10E)



3RW551.



3RW552.

At 40 °C					At 50 °C					SD ¹⁾	Article No.	Price per PU	PU (UNIT, SET, M)	PS*	PG
Operational current	Operating power for three-phase motors				Operational current	Rating [hp] for three-phase motors									
	At 230 V	At 400 V	At 500 V	At 690 V		At 200/208 V	At 220/230 V	At 460/480 V	At 575/600 V						
A	kW	kW	kW	kW	A	hp	hp	hp	hp	d					
Operational voltage 200 ... 600 V															
13	3	5.5	7.5	--	11.5	2	3	7.5	10	5	3RW5513-□HA□5		1	1 unit	42S
18	4	7.5	11	--	15.9	3	5	10	10	5	3RW5514-□HA□5		1	1 unit	42S
25	5.5	11	15	--	22.3	5	7.5	15	20	5	3RW5515-□HA□5		1	1 unit	42S
32	7.5	15	18.5	--	28.4	7.5	10	20	25	5	3RW5516-□HA□5		1	1 unit	42S
38	11	18.5	22	--	33.5	10	10	20	30	5	3RW5517-□HA□5		1	1 unit	42S
Operational voltage 200 ... 690 V															
25	5.5	11	15	22	22.3	5	7.5	15	20	5	3RW5521-□HA□6		1	1 unit	42S
47	11	22	30	45	41.6	10	10	30	40	5	3RW5524-□HA□6		1	1 unit	42S
63	18.5	30	37	55	55.5	15	20	40	50	5	3RW5525-□HA□6		1	1 unit	42S
77	22	37	45	75	68	20	25	50	60	5	3RW5526-□HA□6		1	1 unit	42S
93	22	45	55	90	82.5	25	30	60	75	5	3RW5527-□HA□6		1	1 unit	42S

Type of electrical connection for the control circuit

Screw terminals

Spring-loaded terminals

Control supply voltage

24 V AC/DC

110 ... 250 V AC

¹⁾ 3RW55 soft starter with screw terminals for operational voltage up to 690 V:
Standard delivery time SD = 2 days (d).

Note:

For the constraints for the motor outputs specified here, see page 6/8.

1
3

0
1

Switching devices – Soft starters and solid-state switching devices

SIRIUS 3RW soft starters
High Performance soft starters

IE3/IE4 ready 3RW55 soft starters > Inline circuit

For normal starting (CLASS 10E)



3RW553.



3RW554.



3RW555.

At 40 °C					At 50 °C					SD ¹⁾	Article No.	Price per PU	PU (UNIT, SET, M)	PS*	PG
Operational current	Operating power for three-phase motors				Operational current	Rating [hp] for three-phase motors									
A	At 230 V	At 400 V	At 500 V	At 690 V	A	At 200/208 V	At 220/230 V	At 460/480 V	At 575/600 V	d					
Operational voltage 200 ... 690 V															
113	30	55	75	110	101	30	30	75	100	5	3RW5534-□HA□6		1	1 unit	42S
143	37	75	90	132	128	40	40	100	125	5	3RW5535-□HA□6		1	1 unit	42S
171	45	90	110	160	153	50	50	100	150	5	3RW5536-□HA□6		1	1 unit	42S
210	55	110	132	200	186	60	60	150	150	5	3RW5543-□HA□6		1	1 unit	42S
250	75	132	160	250	220	60	75	150	200	5	3RW5544-□HA□6		1	1 unit	42S
315	90	160	200	315	279	75	100	200	250	5	3RW5545-□HA□6		1	1 unit	42S
370	110	200	250	355	328	100	125	250	300	5	3RW5546-□HA□6		1	1 unit	42S
470	132	250	315	400	416	150	150	350	450	5	3RW5547-□HA□6		1	1 unit	42S
570	160	315	355	560	504	150	200	400	500	5	3RW5548-□HA□6		1	1 unit	42S
630	200	355	400	630	561	200	200	450	600	15	3RW5552-□HA□6		1	1 unit	42S
720	200	400	500	710	641	200	250	500	700	15	3RW5553-□HA□6		1	1 unit	42S
840	250	450	560	800	748	250	300	600	800	15	3RW5554-□HA□6		1	1 unit	42S
1 100	315	560	710	1 000	979	350	400	850	1 100	15	3RW5556-□HA□6		1	1 unit	42S
1 280	400	710	900	1 200	1 139	400	450	1 000	1 250	15	3RW5558-□HA□6		1	1 unit	42S

Type of electrical connection for the control circuit

Spring-loaded terminals
Screw terminals

Control supply voltage

24 V AC/DC
110 ... 250 V AC

- ¹⁾ 3RW55 soft starter with screw terminals for operational voltage up to 690 V:
- Sizes 3 and 4: Standard delivery time SD = 2 days (d).
 - Size 5: Standard delivery time SD = 5 days (d).

Note:

For the constraints for the motor outputs specified here, see page 6/8.

2
60
1

Switching devices – Soft starters and solid-state switching devices

SIRIUS 3RW soft starters

High Performance soft starters

3RW55 soft starters > Inside-delta circuit **IE3/IE4 ready**

Selection and ordering data

For normal starting (CLASS 10E)



3RW551.



3RW552.

At 40 °C for inside-delta circuit				At 50 °C for inside-delta circuit				SD ¹⁾	Article No.	Price per PU	PU (UNIT, SET, M)	PS*	PG
Operational current	Operating power for three-phase motors			Operational current	Rating [hp] for three-phase motors								
	At 230 V	At 400 V	At 500 V		At 200/208 V	At 220/230 V	At 460/480 V	At 575/600 V	d				
A	kW	kW	kW	A	hp	hp	hp	hp					
Operational voltage 200 ... 480 V													
22.5	5.5	11	--	19.9	5	5	10	--	5	3RW5513-□HA□4	1	1 unit	42S
31.5	7.5	15	--	28	7.5	7.5	20	--	5	3RW5514-□HA□4	1	1 unit	42S
43.3	11	18.5	--	39	10	10	25	--	5	3RW5515-□HA□4	1	1 unit	42S
55.4	15	22	--	49	15	15	30	--	5	3RW5516-□HA□4	1	1 unit	42S
65.8	18.5	30	--	58	15	20	40	--	5	3RW5517-□HA□4	1	1 unit	42S
81.4	22	45	--	72	20	25	50	--	5	3RW5524-□HA□4	1	1 unit	42S
109	30	55	--	96	30	30	75	--	5	3RW5525-□HA□4	1	1 unit	42S
133	37	75	--	118	30	40	75	--	5	3RW5526-□HA□4	1	1 unit	42S
161	45	90	--	143	40	50	100	--	5	3RW5527-□HA□4	1	1 unit	42S

Type of electrical connection for the control circuit

Screw terminals

Spring-loaded terminals

Control supply voltage

24 V AC/DC

110 ... 250 V AC

¹⁾ 3RW55 soft starter with screw terminals for operational voltage up to 480 V:
Standard delivery time SD = 1 day (d).

Note:

For the constraints for the motor outputs specified here, see page 6/8.

1
3

0
1

Switching devices – Soft starters and solid-state switching devices

SIRIUS 3RW soft starters

High Performance soft starters

IE3/IE4 ready 3RW55 soft starters > Inside-delta circuit

For normal starting (CLASS 10E)

3RW553.



3RW554.



3RW555.

At 40 °C for inside-delta circuit				At 50 °C for inside-delta circuit				SD ¹⁾	Article No.	Price per PU	PU (UNIT, SET, M)	PS*	PG	
Operational current	Operating power for three-phase motors			Operational current	Rating [hp] for three-phase motors									
	At 230 V	At 400 V	At 500 V		At 200/208 V	At 220/230 V	At 460/480 V	At 575/600 V	d					
A	kW	kW	kW	A	hp	hp	hp	hp						
Operational voltage 200 ... 480 V														
196	55	110	--	175	50	60	125	--	5	3RW5534-□HA□4		1	1 unit	42S
248	75	132	--	222	75	75	150	--	5	3RW5535-□HA□4		1	1 unit	42S
296	90	160	--	265	75	100	200	--	5	3RW5536-□HA□4		1	1 unit	42S
364	110	200	--	322	100	125	250	--	5	3RW5543-□HA□4		1	1 unit	42S
433	132	250	--	381	125	150	300	--	5	3RW5544-□HA□4		1	1 unit	42S
546	160	315	--	483	150	200	400	--	5	3RW5545-□HA□4		1	1 unit	42S
641	200	355	--	568	200	200	450	--	5	3RW5546-□HA□4		1	1 unit	42S
814	250	400	--	721	250	250	600	--	5	3RW5547-□HA□4		1	1 unit	42S
987	315	560	--	873	300	350	750	--	5	3RW5548-□HA□4		1	1 unit	42S
1 091	355	630	--	972	350	400	850	--	15	3RW5552-□HA□4		1	1 unit	42S
1 247	400	710	--	1 110	400	450	950	--	15	3RW5553-□HA□4		1	1 unit	42S
1 454	450	800	--	1 295	450	550	1 150	--	15	3RW5554-□HA□4		1	1 unit	42S
1 905	560	1 000	--	1 695	600	700	1 500	--	15	3RW5556-□HA□4		1	1 unit	42S
2 217	710	1 200	--	1 973	700	850	1 700	--	15	3RW5558-□HA□4		1	1 unit	42S

Type of electrical connection for the control circuit

 Spring-loaded terminals
 Screw terminals

Control supply voltage

 24 V AC/DC
 110 ... 250 V AC

¹⁾ 3RW55 soft starter with screw terminals for operational voltage up to 480 V:
 Standard delivery time SD = 1 day (d).

Note:

For the constraints for the motor outputs specified here, see page 6/8.

 2
 6

 0
 1

Switching devices – Soft starters and solid-state switching devices

SIRIUS 3RW soft starters

High Performance soft starters

3RW55 soft starters > Inside-delta circuit **IE3/IE4 ready**

For normal starting (CLASS 10E)



3RW551.



3RW552.

At 40 °C for inside-delta circuit			At 50 °C for inside-delta circuit				SD ¹⁾	Article No.	Price per PU	PU (UNIT, SET, M)	PS*	PG	
Operational current	Operating power for three-phase motors			Operational current	Rating [hp] for three-phase motors								
	At 230 V	At 400 V	At 500 V		At 200/208 V	At 220/230 V	At 460/480 V	At 575/600 V	d				
A	kW	kW	kW	A	hp	hp	hp	hp					
Operational voltage 200 ... 600 V													
22.5	5.5	11	15	19.9	5	5	10	15	5	3RW5513-□HA□5	1	1 unit	42S
31.5	7.5	15	18.5	28	7.5	7.5	20	25	5	3RW5514-□HA□5	1	1 unit	42S
43.3	11	18.5	22	39	10	10	25	30	5	3RW5515-□HA□5	1	1 unit	42S
55.4	15	22	30	49	15	15	30	40	5	3RW5516-□HA□5	1	1 unit	42S
65.8	18.5	30	37	58	15	20	40	50	5	3RW5517-□HA□5	1	1 unit	42S
43.3	11	18.5	22	39	10	10	25	30	5	3RW5521-□HA□6	1	1 unit	42S
81.4	22	45	45	72	20	25	50	60	5	3RW5524-□HA□6	1	1 unit	42S
109	30	55	55	96	30	30	75	75	5	3RW5525-□HA□6	1	1 unit	42S
133	37	75	90	118	30	40	75	100	5	3RW5526-□HA□6	1	1 unit	42S
161	45	90	110	143	40	50	100	125	5	3RW5527-□HA□6	1	1 unit	42S

Type of electrical connection for the control circuit

Screw terminals
Spring-loaded terminals

Control supply voltage

24 V AC/DC
110 ... 250 V AC

¹⁾ 3RW55 soft starter with screw terminals for operational voltage up to 600 V.
Standard delivery time SD = 2 days (d).

Note:

For the constraints for the motor outputs specified here, see page 6/8.

1
3
0
1

Switching devices – Soft starters and solid-state switching devices

SIRIUS 3RW soft starters

High Performance soft starters

IE3/IE4 ready 3RW55 soft starters > Inside-delta circuit

For normal starting (CLASS 10E)

3RW553.



3RW554.



3RW555.

At 40 °C for inside-delta circuit				At 50 °C for inside-delta circuit				SD ¹⁾	Article No.	Price per PU	PU (UNIT, SET, M)	PS*	PG	
Operational current	Operating power for three-phase motors			Operational current	Rating [hp] for three-phase motors				d					
	At 230 V	At 400 V	At 500 V		At 200/208 V	At 220/230 V	At 460/480 V	At 575/600 V						
A	kW	kW	kW	A	hp	hp	hp	hp						
Operational voltage 200 ... 600 V														
196	55	110	132	175	50	60	125	150	5	3RW5534-□HA□6		1	1 unit	42S
248	75	132	160	222	75	75	150	200	5	3RW5535-□HA□6		1	1 unit	42S
296	90	160	200	265	75	100	200	250	5	3RW5536-□HA□6		1	1 unit	42S
364	110	200	250	322	100	125	250	300	5	3RW5543-□HA□6		1	1 unit	42S
433	132	250	315	381	125	150	300	350	5	3RW5544-□HA□6		1	1 unit	42S
546	160	315	355	483	150	200	400	500	5	3RW5545-□HA□6		1	1 unit	42S
641	200	355	450	568	200	200	450	600	5	3RW5546-□HA□6		1	1 unit	42S
814	250	400	500	721	250	250	600	800	5	3RW5547-□HA□6		1	1 unit	42S
987	315	560	630	873	300	350	750	950	5	3RW5548-□HA□6		1	1 unit	42S
1 091	355	630	710	972	350	400	850	1 050	15	3RW5552-□HA□6		1	1 unit	42S
1 247	400	710	800	1 110	400	450	950	1 250	15	3RW5553-□HA□6		1	1 unit	42S
1 454	450	800	900	1 295	450	550	1 150	1 450	15	3RW5554-□HA□6		1	1 unit	42S
1 905	560	1 000	1 200	1 695	600	700	1 500	1 900	15	3RW5556-□HA□6		1	1 unit	42S
2 217	710	1 200	1 500	1 973	700	850	1 700	2 200	15	3RW5558-□HA□6		1	1 unit	42S

Type of electrical connection for the control circuit

 Spring-loaded terminals
 Screw terminals

Control supply voltage

 24 V AC/DC
 110 ... 250 V AC

- ¹⁾ 3RW55 soft starter with screw terminals for operational voltage up to 600 V:
- Sizes 3 and 4: Standard delivery time SD = 2 days (d).
 - Size 5: Standard delivery time SD = 5 days (d).

Note:

For the constraints for the motor outputs specified here, see page 6/8.

 2
6

 0
1





Switching devices – Soft starters and solid-state switching devices

SIRIUS 3RW soft starters

High Performance soft starters

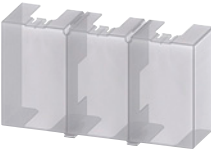
3RW55 soft starters > Accessories

Selection and ordering data





Product designation	Manufacturer's Article No. of the soft starter	Type of product	Application	SD	Article No.	Price per PU	PU (UNIT, SET, M)	PS*	PG	
Fan covers										
 3RW5983-0FC00	Fan cover	3RW551 (1x), 3RW552 (2x), 3RW553 (2x)	--	--	▶	3RW5983-0FC00		1	1 unit	42S
		3RW554 (1x)	--	--	▶	3RW5984-0FC00		1	1 unit	42S
		3RW555 (3x)	--	--	▶	3RW5985-0FC00		1	1 unit	42S
Terminal covers										
 3RW5983-0TC20	Terminal cover	3RW552 (2x), 3RW553 (2x)	--	--	▶	3RW5983-0TC20		1	1 unit	42S
		3RW554 (2x)	--	--	▶	3RW5984-0TC20		1	1 unit	42S
 3RW5984-0TC20										
Enclosure components										
 3RW5950-0GL20	Hinged cover	3RW55	Without cutout	--	▶	3RW5950-0GL20		1	1 unit	42S
Communication modules										
 3RW5980-0CS00	Communication module	3RW55	PROFINET High Feature with integral switch	--	▶	3RW5950-0CH00		1	1 unit	42S
			PROFINET Standard	--	▶	3RW5980-0CS00		1	1 unit	42S
			PROFIBUS	--	▶	3RW5980-0CP00		1	1 unit	42S
 3RW5980-0CE00			EtherNet/IP	--	▶	3RW5980-0CE00		1	1 unit	42S
			Modbus RTU	--	▶	3RW5980-0CR00		1	1 unit	42S
 3RW5980-0CR00			Modbus TCP	--	▶	3RW5980-0CT00		1	1 unit	42S

* You can order this quantity or a multiple thereof. Illustrations are approximate

Switching devices – Soft starters and solid-state switching devices

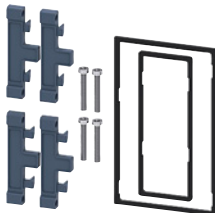
SIRIUS 3RW soft starters
High Performance soft starters

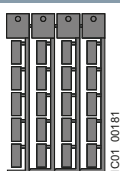
3RW55 soft starters > Accessories

Product designation	Manufacturer's Article No. of the soft starter	Type of product	Application	SD	Article No.	Price per PU	PU (UNIT, SET, M)	PS*	PG
HMI modules									
	IP65 door mounting kit for HMI modules	3RW55	IP65	For HMI modules	▶ 3RW5980-0HD00		1	1 unit	42S
Connecting cables									
	HMI connecting cable	3RW55	5 m, round	For door mounting	▶ 3RW5980-0HC60		1	1 unit	42S
			2.5 m, round		▶ 3UF7933-0BA00-0		1	1 unit	42J
			1.0 m, round		▶ 3UF7937-0BA00-0		1	1 unit	42J
			0.5 m, round		▶ 3UF7932-0BA00-0		1	1 unit	42J
Further accessories									
	Push-in lugs for wall mounting	--	Two lugs are required per device	For HMI modules and communication modules	2	3ZY1311-0AA00	1	10 units	41L
Blank labels									
	Unit labeling plates¹⁾	--	20 mm x 7 mm, titanium gray	For SIRIUS devices	20	3RT2900-1SB20	100	340 units	41B
3RW55 starter kit									
	SIRIUS 3RW55 starter kit	--	Including 3RW55 soft starter 13 A, 200 ... 480 V, 24 V AC/DC Soft Starter ES V15.1, 24 V power supply unit, connection cable and RJ45 network cable	5	3RW5951-1ES04		1	1 unit	42S

¹⁾ PC labeling systems for individual inscription of unit labeling plates are available from: murrplastik Systemtechnik GmbH (see page 16/16).

Switching devices – Soft starters and solid-state switching devices

SIRIUS 3RW soft starters

High Performance soft starters

3RW55 Failsafe soft starters > General data

Overview

More information

Homepage, see www.siemens.com/sirius-soft-starter

Industry Mall, see www.siemens.com/product?3RW55Failsafe

TIA Selection Tool Cloud (TST Cloud), see <https://www.siemens.com/tstcloud/?node=3rw55>

Industry Online Support (SIOS) topic page, see <https://support.industry.siemens.com/cs/ww/en/view/109747404>

Simulation Tool for Soft Starters (STS), see page 6/9 or <https://support.industry.siemens.com/cs/ww/en/view/101494917>

SIRIUS Soft Starter ES (TIA Portal), see page 6/9 or <https://support.industry.siemens.com/cs/ww/en/view/24230/dl>



SIRIUS 3RW55 Failsafe soft starters device family

Equipped with the utmost functionality, the SIRIUS 3RW55 Failsafe High Performance soft starters confidently handle even difficult starting and stopping operations. Thanks to innovative torque control, the device can be used for drives with an output of between 5.5 kW and 560 kW (at 400 V).

The innovative 3RW55 Failsafe soft starter features an integrated fail-safe digital input for directly connecting the EMERGENCY STOP, and thus covers SIL 1 STO applications. The HMI (with color display, local interface and a slot for micro SD memory card) and plug-in communication modules (PROFINET, PROFIBUS, EtherNet/IP and Modbus) ensure maximum flexibility.

With their modern hybrid switching technology, the 3RW55 Failsafe soft starters offer efficient switching for long-term, energy-saving use.

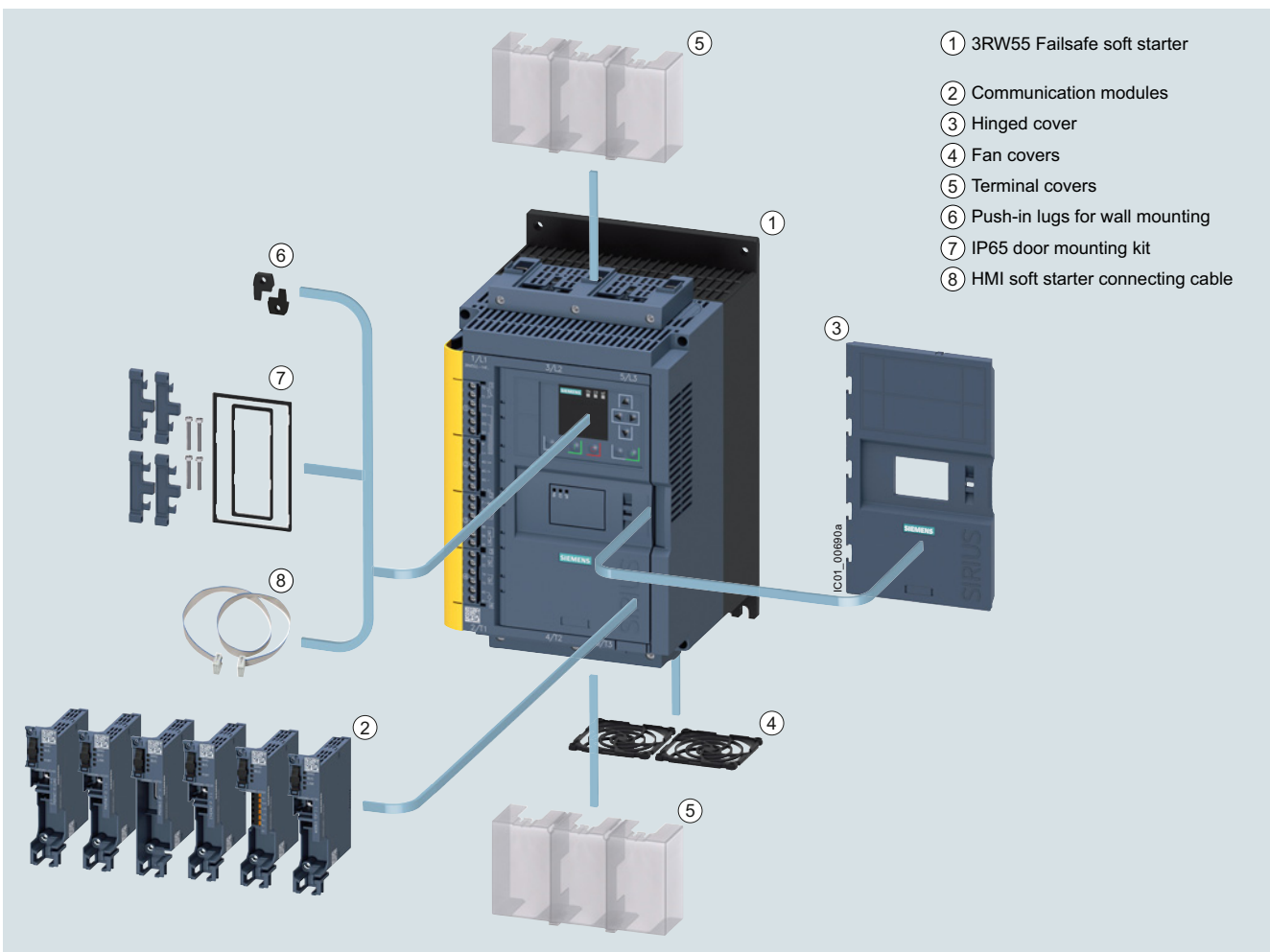

SIRIUS 3RW55 Failsafe High Performance soft starter with accessories (see page 6/52)

Switching devices – Soft starters and solid-state switching devices

SIRIUS 3RW soft starters

High Performance soft starters

3RW55 Failsafe soft starters > General data

Benefits



Product characteristics / function	Performance features / benefits
Automatic parameterization	Extremely easy commissioning and reliability even under changing load conditions
Hybrid switching technology and 3-phase motor control	Minimum power loss and optimum/symmetrical motor control
Integration into TIA Portal – communication modules optional	Efficient configuration and maximum flexibility in automation engineering
Removable HMI with color display, local interface, slot for micro SD memory card	Maximum flexibility with regard to user interface and intuitive menu guidance
Pump stop and torque control	Reduced mechanical loading and optimum pump stop control
Certified according to ATEX/IECEX directive	Suitable for the starting of explosion-proof motors
Fail-safe disconnection up to SIL 3 - PL e / STO	Reduced costs and space requirements thanks to direct wiring of the EMERGENCY STOP mushroom pushbutton to the soft starter for SIL 1

Switching devices – Soft starters and solid-state switching devices

SIRIUS 3RW soft starters

High Performance soft starters

3RW55 Failsafe soft starters > General data

Technical specifications

More information

Technical specifications, see
<https://support.industry.siemens.com/cs/ww/en/ps/25776/td>
 Equipment Manual, see
<https://support.industry.siemens.com/cs/ww/en/view/109753752>

FAQs, see <https://support.industry.siemens.com/cs/ww/en/ps/25776/faq>
 Simulation Tool for Soft Starters (STS), see page 6/9 or
<https://support.industry.siemens.com/cs/ww/en/view/101494917>

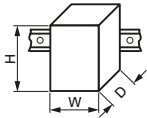
Type		3RW551.-.HF.4	3RW552.-.HF.4 3RW553.-.HF.4	3RW554.-.HF.4
Installation/fixing/dimensions				
Width x height x depth	mm	170 × 275 × 152	185 × 306 × 203	210 × 393 × 203
				
Type of mounting		Screw fixing		
Mounting position		Vertical (can be rotated +/- 90° and tilted +/- 22.5° forward or backward)		
Distance to be maintained with side-by-side mounting				
• Above	mm	100		
• At the side	mm	5		
• Below	mm	75		
Maximum installation altitude above sea level¹⁾	m	2 000		
Degree of protection IP on the front acc. to IEC 60529		IP20	IP00 (IP20 with cover)	
Touch protection on the front acc. to IEC 60529		Finger-safe for vertical touching from the front	Finger-safe for vertical touching from the front with cover	

Ambient conditions

Ambient temperature

- During operation²⁾ °C -25 ... +60
- During storage and transport °C -40 ... +80

Environmental category according to IEC 60721

- During operation 3K6 (no ice formation, only occasional condensation), 3C3 (no salt mist), 3S2 (sand must not get into the devices), 3M6
- During storage 1K6 (only occasional condensation), 1C2 (no salt mist), 1S2 (sand must not get into the devices), 1M4
- During transport 2K2, 2C1, 2S1, 2M2 (max. height of fall 0.3 m)

¹⁾ Derating from 1 000 m, see characteristic curve on page 6/8.

²⁾ Note derating above 40 °C.

Type		3RW55.-.HF04	3RW55.-.HF14
Control circuit/control			
Control supply voltage			
• At AC/DC	V	24/24	--/--
• At AC	V	--	110 ... 250
Relative negative tolerance/relative positive tolerance of the control supply voltage			
• At AC	%	-20/20	-15/10
• At DC	%	-20/20	--/--
Frequency of the control supply voltage	Hz	50 ... 60	
• Relative negative tolerance/relative positive tolerance	%	-10/10	
Type of overvoltage protection		Varistors	
Type of short-circuit protection for control circuit¹⁾		Fuse 4 A gG ($I_{cu} = 1$ kA), fuse 6 A quick-response ($I_{cu} = 1$ kA), MCB C1 ($I_{cu} = 600$ A), MCB C6 ($I_{cu} = 300$ A)	

¹⁾ Not included in scope of supply

Type		3RW55.-.HF.4
Power electronics		
Operational voltage, rated value	V	200 ... 480
• Relative negative tolerance/relative positive tolerance	%	-15/10
Operational voltage for inside-delta circuit, rated value	V	200 ... 480
• Relative negative tolerance/relative positive tolerance	%	-15/10
Operating frequency	Hz	50 ... 60
• Relative negative tolerance/relative positive tolerance	%	-10/10
Minimum load [% of I_M]¹⁾	%	10
Maximum cable length between soft starter and motor	m	800

¹⁾ Relative to set I_e .

Switching devices – Soft starters and solid-state switching devices

SIRIUS 3RW soft starters

High Performance soft starters

3RW55 Failsafe soft starters > General data

Type		3RW5513	3RW5514	3RW5515	3RW5516	3RW5517
Rated operational current I_e	A	13	18	25	32	38
Power electronics						
Load rating with rated operational current I_e						
IEC + UL/CSA, individual mounting at 40/50/60 °C, A AC-53a						
		13/11.5/10.5	18/15.9/13.8	25/22.3/19.6	25/22.3/19.6	38/33.5/30.5
Permissible rated motor current and starts/h						
Normal starting (CLASS 10A)						
Rated motor current I_M , $T_u = 40/50/60$ °C						
ON period = 70%; motor protection activated						
	A	13/11.5/10.5	18/15.9/13.8	25/22.3/19.6	32/28.4/26	38/33.5/30.5
• 300% I_M						
- Start-up time 5 s	1/h	43	43	43	43	43
- Start-up time 10 s	1/h	18	18	18	18	18
• 350% I_M						
- Start-up time 5 s	1/h	28	28	28	28	28
- Start-up time 10 s	1/h	10	10	10	10	10
Normal starting (CLASS 10E)						
Rated motor current I_M , $T_u = 40/50/60$ °C						
ON period = 70%; motor protection activated						
	A	13/11.5/10.5	18/15.9/13.8	25/22.3/19.6	32/28.4/26	38/33.5/30.5
• 300% I_M						
- Start-up time 10 s	1/h	21	21	21	21	21
- Start-up time 20 s	1/h	8	8	8	8	8
• 350% I_M						
- Start-up time 10 s	1/h	13	13	13	13	13
- Start-up time 20 s	1/h	4	4	4	4	4
Heavy starting (CLASS 20E)						
Rated motor current I_M , $T_u = 40/50/60$ °C						
ON period = 70%; motor protection activated						
	A	13/11.5/10.5	18/15.9/13.8	25/22.3/19.6	29.6/27.2/23.6	33.5/30.5/27.5
• 300% I_M						
- Start-up time 20 s	1/h	10	10	10	10	10
- Start-up time 40 s	1/h	4	4	4	4	4
• 350% I_M						
- Start-up time 20 s	1/h	7	7	7	7	7
- Start-up time 40 s	1/h	2.5	2.5	2.5	2.5	2.5
Heavy starting (CLASS 30E)						
Rated motor current I_M , $T_u = 40/50/60$ °C						
ON period = 70%; motor protection activated						
	A	13/11.5/10.5	18/15.9/13.8	25/22.3/19.6	26/23.6/21.2	29/26/23
• 300% I_M						
- Start-up time 30 s	1/h	7	7	7	7	7
- Start-up time 60 s	1/h	3	3	3	3	3
• 350% I_M						
- Start-up time 30 s	1/h	4	4	4	4	4
- Start-up time 60 s	1/h	1.8	1.8	1.8	1.8	1.8
Adjustable rated motor current I_M						
• Minimum/maximum	A	2.5/13	3.5/18	5/25	6.5/32	7.5/38
• Minimum/maximum in inside-delta circuits	A	4.3/22.5	6.1/31.1	8.7/43.3	11.3/55.4	13/65.8

Switching devices – Soft starters and solid-state switching devices

SIRIUS 3RW soft starters

High Performance soft starters

3RW55 Failsafe soft starters > General data

Type		3RW5524	3RW5525	3RW5526	3RW5527
Rated operational current I_e	A	47	63	77	93
Power electronics					
Load rating with rated operational current I_e					
IEC + UL/CSA, individual mounting at 40/50/60 °C, A AC-53a		47/41.6/36.2	63/55.5/50.5	77/68/62	93/82.5/75.5
Permissible rated motor current and starts/h					
Normal starting (CLASS 10A)					
Rated motor current I_M , $T_u = 40/50/60$ °C ON period = 70%; motor protection activated	A	47/41.6/36.2	63/55.5/50.5	77/68/62	93/82.5/75.5
• 300% I_M					
- Start-up time 5 s	1/h	43	43	43	43
- Start-up time 10 s	1/h	18	18	18	18
• 350% I_M					
- Start-up time 5 s	1/h	28	28	28	28
- Start-up time 10 s	1/h	10	10	10	10
Normal starting (CLASS 10E)					
Rated motor current I_M , $T_u = 40/50/60$ °C ON period = 70%; motor protection activated	A	47/41.6/36.2	63/55.5/50.5	77/68/62	93/82.5/75.5
• 300% I_M					
- Start-up time 10 s	1/h	21	21	21	21
- Start-up time 20 s	1/h	8	8	8	8
• 350% I_M					
- Start-up time 10 s	1/h	13	13	13	13
- Start-up time 20 s	1/h	4	4	4	4
Heavy starting (CLASS 20E)					
Rated motor current I_M , $T_u = 40/50/60$ °C ON period = 70%; motor protection activated	A	47/41.6/36.2	63/55.5/50.5	77/68/62	93/82.5/75.5
• 300% I_M					
- Start-up time 20 s	1/h	10	10	10	10
- Start-up time 40 s	1/h	4	4	4	4
• 350% I_M					
- Start-up time 20 s	1/h	7	7	7	7
- Start-up time 40 s	1/h	2.5	0	0	0
Heavy starting (CLASS 30E)					
Rated motor current I_M , $T_u = 40/50/60$ °C ON period = 70%; motor protection activated	A	43.4/38/34.4	53/48/43	68/62/56	82.5/75.5/65
• 300% I_M					
- Start-up time 30 s	1/h	7	7	7	7
- Start-up time 60 s	1/h	3	3	3	3
• 350% I_M					
- Start-up time 30 s	1/h	4	4	4	4
- Start-up time 60 s	1/h	1.8	1.8	1.8	1.8
Adjustable rated motor current I_M					
• Minimum/maximum	A	10/47	13/63	16/77	19/93
• Minimum/maximum in inside-delta circuits	A	17.3/81.4	22.5/109	27.7/133	32.9/161

Switching devices – Soft starters and solid-state switching devices

SIRIUS 3RW soft starters

High Performance soft starters

3RW55 Failsafe soft starters > General data

Type		3RW5534	3RW5535	3RW5536
Rated operational current I_e	A	113	143	171
Power electronics				
Load rating with rated operational current I_e				
IEC + UL/CSA, individual mounting at 40/50/60 °C, A AC-53a	A	113/101/89	143/128/118	171/153/141
Permissible rated motor current and starts/h				
Normal starting (CLASS 10A)				
Rated motor current I_M , $T_u = 40/50/60$ °C ON period = 70%; motor protection activated	A	113/101/89	143/128/118	171/153/141
• 300% I_M				
- Start-up time 5 s	1/h	43	43	35
- Start-up time 10 s	1/h	18	18	13
• 350% I_M				
- Start-up time 5 s	1/h	28	17	10
- Start-up time 10 s	1/h	10	4	0
Normal starting (CLASS 10E)				
Rated motor current I_M , $T_u = 40/50/60$ °C ON period = 70%; motor protection activated	A	113/101/89	143/128/118	171/153/141
• 300% I_M				
- Start-up time 10 s	1/h	21	21	14
- Start-up time 20 s	1/h	8	7	4
• 350% I_M				
- Start-up time 10 s	1/h	13	4	0
- Start-up time 20 s	1/h	4	0	0
Heavy starting (CLASS 20E)				
Rated motor current I_M , $T_u = 40/50/60$ °C ON period = 70%; motor protection activated	A	109/97/85	128/113/103	141/129/117
• 300% I_M				
- Start-up time 20 s	1/h	10	10	10
- Start-up time 40 s	1/h	4	4	4
• 350% I_M				
- Start-up time 20 s	1/h	7	6	6
- Start-up time 40 s	1/h	0	0	0
Heavy starting (CLASS 30E)				
Rated motor current I_M , $T_u = 40/50/60$ °C ON period = 70%; motor protection activated	A	89/81/74	108/98/88	117/105/93
• 300% I_M				
- Start-up time 30 s	1/h	7	7	7
- Start-up time 60 s	1/h	3	3	3
• 350% I_M				
- Start-up time 30 s	1/h	4	4	4
- Start-up time 60 s	1/h	1.8	1.8	1.8
Adjustable rated motor current I_M				
• Minimum/maximum	A	23/113	29/143	34/171
• Minimum/maximum in inside-delta circuits	A	39.8/195	50.2/247	58.9/296

Switching devices – Soft starters and solid-state switching devices

SIRIUS 3RW soft starters

High Performance soft starters

3RW55 Failsafe soft starters > General data

Type		3RW5543	3RW5544	3RW5545	3RW5546	3RW5547	3RW5548
Rated operational current I_e	A	210	250	315	370	470	570
Power electronics							
Load rating with rated operational current I_e							
IEC + UL/CSA, individual mounting at 40/50/60 °C, A AC-53a	A	210/186/170	250/220/200	315/279/255	370/328/300	470/416/380	570/504/460
Permissible rated motor current and starts/h							
Normal starting (CLASS 10A)							
Rated motor current I_M , $T_u = 40/50/60$ °C ON period = 70%; motor protection activated	A	210/186/170	250/220/200	315/279/255	370/328/300	470/416/380	570/504/460
• 300% I_M							
- Start-up time 5 s	1/h	43	43	38	43	32	13
- Start-up time 10 s	1/h	13	18	14	18	13	3
• 350% I_M							
- Start-up time 5 s	1/h	14	28	19	28	19	4
- Start-up time 10 s	1/h	0	10	5	10	6	0.4
Normal starting (CLASS 10E)							
Rated motor current I_M , $T_u = 40/50/60$ °C ON period = 70%; motor protection activated	A	210/186/170	250/220/200	315/279/255	370/328/300	470/416/380	551/490/445
• 300% I_M							
- Start-up time 10 s	1/h	13	21	14	20	13	5
- Start-up time 20 s	1/h	2	8	4	8	3	--
• 350% I_M							
- Start-up time 10 s	1/h	0	13	5	12	6	1
- Start-up time 20 s	1/h	0	4	0	3	0.4	--
Heavy starting (CLASS 20E)							
Rated motor current I_M , $T_u = 40/50/60$ °C ON period = 70%; motor protection activated	A	162/146/130	200/180/160	231/207/183	258/230/202	272/254/236	284/262/240
• 300% I_M							
- Start-up time 20 s	1/h	10	10	10	10	10	10
- Start-up time 40 s	1/h	4	4	4	4	4	4
• 350% I_M							
- Start-up time 20 s	1/h	7	7	7	7	7	7
- Start-up time 40 s	1/h	2	2.5	2.5	2.5	2.5	2.5
Heavy starting (CLASS 30E)							
Rated motor current I_M , $T_u = 40/50/60$ °C ON period = 70%; motor protection activated	A	138/122/106	160/140/120	183/159/135	202/174/160	210/190/170	220/200/180
• 300% I_M							
- Start-up time 30 s	1/h	7	7	7	7	7	7
- Start-up time 60 s	1/h	3	3	3	3	3	3
• 350% I_M							
- Start-up time 30 s	1/h	4	4	4	4	4	4
- Start-up time 60 s	1/h	1.8	1.8	1.8	1.8	1.8	1.8
Adjustable rated motor current I_M							
• Minimum/maximum	A	42/210	50/250	63/315	74/370	94/470	114/570
• Minimum/maximum in inside-delta circuits	A	72.7/363	86.6/433	109.1/545	128.2/640	162.8/814	197.5/987

Switching devices – Soft starters and solid-state switching devices

SIRIUS 3RW soft starters

High Performance soft starters

3RW55 Failsafe soft starters > General data

Motor feeders according to IEC with 3RV2 motor starter protectors or 3VA circuit breakers (without semiconductor protection)

Type of coordination "1", CLASS 10,
short-circuit breaking capacity I_q in kA, see table

Note:

For general recommendations for constructing motor feeders with soft starters, see page 6/11.

Soft starters	Motor starter protectors				Motor starter protectors			
	for 400 V systems		for 480 V systems		for 400 V systems		for 480 V systems	
Q11 Type	Q1 Type	I_q kA	Q1 Type	I_q kA	Q1 Type	I_q kA	Q1 Type	I_q kA
Type of coordination "1"	Inline circuit				Inside-delta circuit			
3RW5513	3RV2032-4TA10	65	3RV2032-4TA10	18	3RV2032-4DA10	65	3RV2032-4DA10	18
3RW5514	3RV2032-4DA10	65	3RV2032-4DA10	15	3RV2032-4EA10	65	3RV2032-4EA10	15
3RW5515	3RV2032-4EA10	65	3RV2032-4EA10	15	3RV2032-4VA10	65	3RV2032-4VA10	15
3RW5516	3RV2032-4VA10	65	3RV2032-4VA10	10	3RV2032-4JA10	65	3RV2032-4JA10	10
3RW5517	3RV2032-4WA10	65	3RV2032-4WA10	10	3RV2032-4RA10	65	3RV2032-4RA10	10
3RW5524	3RV2032-4JA10	65	3RV2032-4JA10	10	3RV2032-4RA10	65	3RV2032-4RA10	10
3RW5525	3VA2163-7MN32-0AA0	65	3VA2163-7MN32-0AA0	20	3VA2110-7MN32-0AA0	65	3VA2110-7MN32-0AA0	20
3RW5526	3VA2110-7MN32-0AA0	65	3VA2110-7MN32-0AA0	20	3VA2216-7MN32-0AA0	65	3VA2216-7MN32-0AA0	20
3RW5527	3VA2216-7MN32-0AA0	15	3VA2216-7MN32-0AA0	10	3VA2220-7MN32-0AA0	15	3VA2220-7MN32-0AA0	10
3RW5534	3VA2216-7MN32-0AA0	65	--	--	3VA2220-7MN32-0AA0	65	--	--
3RW5535	3VA2220-7MN32-0AA0	65	--	--	3VA2325-7MN32-0AA0	65	--	--
3RW5536	3VA2325-7MN32-0AA0	30	3VA2325-7MN32-0AA0	10	3VA2440-7MN32-0AA0	30	3VA2440-7MN32-0AA0	10
3RW5543	3VA2325-7MN32-0AA0	65	3VA2325-7MN32-0AA0	65	3VA2440-7MN32-0AA0	65	3VA2440-7MN32-0AA0	65
3RW5544	3VA2440-7MN32-0AA0	65	3VA2440-7MN32-0AA0	65	3VA2450-7MN32-0AA0	65	3VA2450-7MN32-0AA0	65
3RW5545	3VA2440-7MN32-0AA0	65	3VA2440-7MN32-0AA0	65	3VA2580-6HN32-0AA0	65	3VA2580-6HN32-0AA0	65
3RW5546	3VA2440-7MN32-0AA0	65	3VA2440-7MN32-0AA0	65	3VA2580-6HN32-0AA0	65	3VA2580-6HN32-0AA0	65
3RW5547	3VA2450-7MN32-0AA0	65	3VA2450-7MN32-0AA0	65	3VA2510-6HN32-0AA0	65	3VA2510-6HN32-0AA0	65
3RW5548	3VA2580-6HN32-0AA0	65	3VA2580-6HN32-0AA0	65	3VA2510-6HN32-0AA0	65	3VA2510-6HN32-0AA0	65

Note:

The service factor and measurement inaccuracies, for example, have been taken into account for the selection of the specified motor starter protectors/circuit breakers; the specified short-circuit breaking capacities I_q in kA are covered by combination tests. Smaller motor starter protectors/circuit breakers from the same series can be used at any time as smaller ones trip more quickly in the event of a short circuit (unchanged short-circuit breaking capacity) and thus protect the soft starter in any case. The dimensioning of the short-circuit components must match the connected three-phase motor, the short-circuit and overload requirements of the application, and the line protection for the cables used.

Switching devices – Soft starters and solid-state switching devices

SIRIUS 3RW soft starters

High Performance soft starters

3RW55 Failsafe soft starters > General data

Motor feeders according to IEC with 3NA3 fuses

gG class full-range fuses for cable and line protection according to IEC 60269-2, without semiconductor protection

Type of coordination "1",
short-circuit breaking capacity $I_{q} = 65 \text{ kA}$

Note:

For general recommendations for constructing motor feeders with soft starters, see page 6/11.

Soft starters	Inline circuit		Inside-delta circuit		
	gG class fuse	Line contactor (optional)	gG class fuse	Line contactor (optional)	Line contactor (optional)
Q11 Type	F1 Type	Q21 Type	F1 Type	Q21 Type	Q21 Type
Type of coordination "1"	Type of coordination "1" TOC 1		Type of coordination "1" TOC 1		
3RW5513	3NA3820-6	3RT2025	3NA3820-6	3RT2027	3RT2025
3RW5514	3NA3820-6	3RT2026	3NA3820-6	3RT2027	3RT2026
3RW5515	3NA3822-6	3RT2027	3NA3822-6	3RT2036	3RT2027
3RW5516	3NA3824-6	3RT2035	3NA3824-6	3RT2037	3RT2035
3RW5517	3NA3824-6	3RT2035	3NA3824-6	3RT2038	3RT2035
3RW5524	3NA3824-6	3RT2036	3NA3824-6	3RT2046	3RT2036
3RW5525	3NA3830-6	3RT2037	3NA3830-6	3RT2047	3RT2037
3RW5526	3NA3132-6	3RT2038	3NA3132-6	3RT1055	3RT2038
3RW5527	3NA3136-6	3RT2046	3NA3136-6	3RT1056	3RT2046
3RW5534	3NA3244-6	3RT1054	3NA3244-6	3RT1064	3RT1054
3RW5535	3NA3244-6	3RT1055	3NA3244-6	3RT1065	3RT1055
3RW5536	3NA3365-6	3RT1056	3NA3365-6	3RT1066	3RT1056
3RW5543	2 x 3NA3354-6	3RT1064	2 x 3NA3354-6	3RT1075	3RT1064
3RW5544	2 x 3NA3354-6	3RT1065	2 x 3NA3354-6	3RT1076	3RT1065
3RW5545	2 x 3NA3365-6	3RT1075	2 x 3NA3365-6	3TF68	3RT1075
3RW5546	2 x 3NA3365-6	3RT1075	2 x 3NA3365-6	3TF69	3RT1075
3RW5547	2 x 3NA3365-6	3RT1076	2 x 3NA3365-6	3TF69	3RT1076
3RW5548	2 x 3NA3365-6	3TF68	2 x 3NA3365-6	--	3TF68

Note:

The specified short-circuit breaking capacities I_{q} in kA are covered by combination tests. Smaller fuses than those specified can be used at any time as smaller ones trip more quickly in the event of a short circuit (unchanged short-circuit breaking capacity) and thus protect the soft starter in any case. The dimensioning of the short-circuit components must, however, be suitable for the connected three-phase motor and the line protection for the cables used.

Switching devices – Soft starters and solid-state switching devices

SIRIUS 3RW soft starters

High Performance soft starters

3RW55 Failsafe soft starters > General data

Motor feeders according to IEC with 3NE1 SITOR fuses

gR class full-range fuses for semiconductor protection, cable and line protection

Type of coordination "2",
short-circuit breaking capacity $I_{cs} = 65 \text{ kA}$

Note:

For general recommendations for constructing motor feeders with soft starters, [see page 6/11](#).

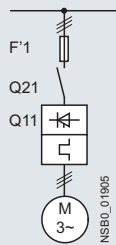

Soft starters	gR class fuse	Line contactor (optional)
Q11 Type	for systems up to 480 V F'1 Type	for systems up to 480 V Q21 Type
Type of coordination "2"	ToC 2 Inline circuit	
3RW5513	3NE1815-0	3RT2025
3RW5514	3NE1802-0	3RT2026
3RW5515	3NE1817-0	3RT2027
3RW5516	3NE1818-0	3RT2035
3RW5517	3NE1820-0	3RT2035
3RW5524	3NE1021-2	3RT2036
3RW5525	3NE1022-0	3RT2037
3RW5526	3NE1224-0	3RT2038
3RW5527	3NE1224-0	3RT2046
3RW5534	3NE1225-0	3RT1054
3RW5535	3NE1227-0	3RT1055
3RW5536	3NE1230-0	3RT1056
3RW5543	3NE1230-2	3RT1064
3RW5544	3NE1331-0	3RT1065
3RW5545	3NE1334-2	3RT1075
3RW5546	3NE1334-2	3RT1075
3RW5547	3NE1436-2	3RT1076
3RW5548	3NE1437-2	3TF68

Note:

The specified short-circuit breaking capacities I_{cs} in kA are covered by combination tests. Smaller fuses than those specified can be used at any time as smaller ones trip more quickly in the event of a short circuit (unchanged short-circuit breaking capacity) and thus protect the soft starter in any case. The dimensioning of the short-circuit components must, however, be suitable for the connected three-phase motor and the line protection for the cables used.

In inside-delta circuits, a gR class full-range fuse could not provide the semiconductor protection of the delta-connected soft starter with a short-circuit breaking capacity that is adequate for practical use. In this case, we recommend using aR class partial-range fuses for semiconductor protection for type of coordination "2" ([see page 6/48](#)).

Switching devices – Soft starters and solid-state switching devices

SIRIUS 3RW soft starters

High Performance soft starters

3RW55 Failsafe soft starters > General data

Motor feeders according to IEC with 3NE8 / 3NE3 / 3NC3 fuses

aR class partial-range fuses for semiconductor protection

Type of coordination "2",
short-circuit breaking capacity $I_{q} = 65 \text{ kA}$

Note:

For general recommendations for constructing motor feeders with soft starters, [see page 6/11](#).

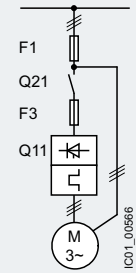
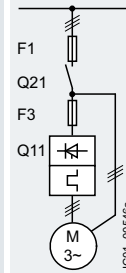
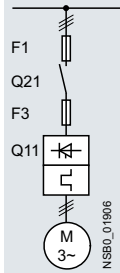

Soft starters	Inline circuit			Inside-delta circuit			
	gG class fuse	aR class fuse	Line contactor (optional)	gG class fuse	aR class fuse	Line contactor (optional)	Line contactor (optional)
for systems up to 480 V	for systems up to 480 V	for systems up to 480 V	for systems up to 480 V	for systems up to 480 V	for systems up to 480 V	for systems up to 480 V in the supply cable	for systems up to 480 V in the delta
Q11	F1	F3	Q21	F1	F3	Q21	Q21
Type	Type	Type	Type	Type	Type	Type	Type
Type of coordination "2"	Type of coordination "2"			Type of coordination "2"			
3RW5513	3NA3820-6	3NE8017-1	3RT2025	3NA3820-6	3NE8017-1	3RT2027	3RT2025
3RW5514	3NA3820-6	3NE8020-1	3RT2026	3NA3820-6	3NE8020-1	3RT2027	3RT2026
3RW5515	3NA3822-6	3NE8021-1	3RT2027	3NA3822-6	3NE8021-1	3RT2036	3RT2027
3RW5516	3NA3824-6	3NE8022-1	3RT2035	3NA3824-6	3NE8022-1	3RT2037	3RT2035
3RW5517	3NA3824-6	3NE8024-1	3RT2035	3NA3824-6	3NE8024-1	3RT2038	3RT2035
3RW5524	3NA3824-6	3NE8024-1	3RT2036	3NA3824-6	3NE8024-1	3RT2046	3RT2036
3RW5525	3NA3830-6	3NE3227	3RT2037	3NA3830-6	3NE3227	3RT2047	3RT2037
3RW5526	3NA3132-6	3NE3227	3RT2038	3NA3132-6	3NE3227	3RT1055	3RT2038
3RW5527	3NA3136-6	3NE3227	3RT2046	3NA3136-6	3NE3227	3RT1056	3RT2046
3RW5534	3NA3244-6	3NE3231	3RT1054	3NA3244-6	3NE3231	3RT1064	3RT1054
3RW5535	3NA3244-6	3NE3233	3RT1055	3NA3244-6	3NE3233	3RT1065	3RT1055
3RW5536	3NA3365-6	3NE3334-0B	3RT1056	3NA3365-6	3NE3334-0B	3RT1066	3RT1056
3RW5543	2 x 3NA3354-6	3NE3333	3RT1064	2 x 3NA3354-6	3NE3333	3RT1075	3RT1064
3RW5544	2 x 3NA3354-6	3NE3335	3RT1065	2 x 3NA3354-6	3NE3335	3RT1076	3RT1065
3RW5545	2 x 3NA3365-6	--	3RT1075	2 x 3NA3365-6	--	3TF68	3RT1075
3RW5546	2 x 3NA3365-6	--	3RT1075	2 x 3NA3365-6	--	3TF69	3RT1075
3RW5547	2 x 3NA3365-6	3NE3340-8	3RT1076	2 x 3NA3365-6	3NE3340-8	3TF69	3RT1076
3RW5548	2 x 3NA3365-6	3NC3342-1U	3TF68	2 x 3NA3365-6	3NC3342-1U	--	3TF68

Note:

The specified short-circuit breaking capacities I_{q} in kA are covered by combination tests. Smaller fuses than those specified can be used at any time as smaller ones trip more quickly in the event of a short circuit (unchanged short-circuit breaking capacity) and thus protect the soft starter in any case. The dimensioning of the short-circuit components must, however, be suitable for the connected three-phase motor and the line protection for the cables used.

For CLASS 10 applications, as an alternative to the gG class full-range fuses for cable and line protection 3NA3 (F1), 3RV2 motor starter protectors or 3VA circuit breakers can also be used, possibly with reduced short-circuit breaking capacity ([see page 6/45](#)). In these cases, optional line contactors can be dispensed with.

Switching devices – Soft starters and solid-state switching devices

SIRIUS 3RW soft starters

High Performance soft starters

3RW55 Failsafe soft starters > General data

Reversing operation with reversing contactors

Note:

For general recommendations for constructing motor feeders with soft starters, [see page 6/11](#).

(For an example circuit, [see 3RW55 Equipment Manual, Appendix A.3](#))

Soft starters	Reversing contactor assembly for systems up to 480 V	For reversing contactor for systems up to 480 V
Q11 Type	Q21 / Q22 Type	Q21 / Q22 Type
3RW5513	3RA2325	3RT2025
3RW5514	3RA2326	3RT2026
3RW5515	3RA2327	3RT2027
3RW5516	3RA2335	3RT2035
3RW5517	3RA2335	3RT2035
3RW5524	3RA2336	3RT2036
3RW5525	3RA2337	3RT2037
3RW5526	3RA2338	3RT2038
3RW5527	3RA2346	3RT2046
3RW5534	--	3RT1054
3RW5535	--	3RT1055
3RW5536	--	3RT1056
3RW5543	--	3RT1064
3RW5544	--	3RT1065
3RW5545	--	3RT1075
3RW5546	--	3RT1075
3RW5547	--	3RT1076
3RW5548	--	3TF68

Switching devices – Soft starters and solid-state switching devices

SIRIUS 3RW soft starters

High Performance soft starters

3RW55 Failsafe soft starters > Inline circuit **IE3/IE4 ready**

Selection and ordering data

For normal starting (CLASS 10E)

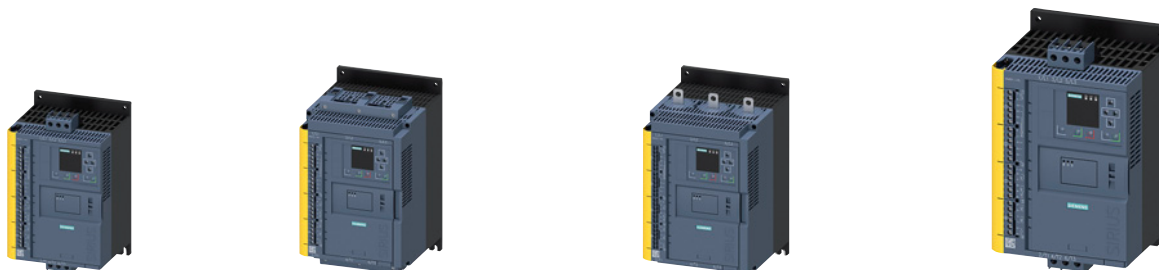

3RW551.

3RW552.

3RW553.

3RW554.

At 40 °C			At 50 °C			SD ¹⁾	Article No.	Price per PU	PU (UNIT, SET, M)	PS*	PG	
Operational current	Operating power for three-phase motors		Operational current	Rating [hp] for three-phase motors								
	At 230 V	At 400 V		At 200/208 V	At 220/230 V	At 460/480 V	d					
A	kW	kW	A	hp	hp	hp						
Operational voltage 200 ... 480 V												
13	3	5.5	11.5	2	3	7.5	5	3RW5513-□HF□4		1	1 unit	42S
18	4	7.5	15.9	3	5	10	5	3RW5514-□HF□4		1	1 unit	42S
25	5.5	11	22.3	5	7.5	15	5	3RW5515-□HF□4		1	1 unit	42S
32	7.5	15	28.4	7.5	10	20	5	3RW5516-□HF□4		1	1 unit	42S
38	11	18.5	33.5	10	10	20	5	3RW5517-□HF□4		1	1 unit	42S
47	11	22	41.6	10	10	30	5	3RW5524-□HF□4		1	1 unit	42S
63	18.5	30	55.5	15	20	40	5	3RW5525-□HF□4		1	1 unit	42S
77	22	37	68	20	25	50	5	3RW5526-□HF□4		1	1 unit	42S
93	22	45	82.5	25	30	60	5	3RW5527-□HF□4		1	1 unit	42S

Type of electrical connection for the control circuit

Screw terminals

Spring-loaded terminals

Control supply voltage

24 V AC/DC

110 ... 250 V AC

¹⁾ 3RW55 soft starter with screw terminals for operational voltage up to 480 V: Standard delivery time SD = 1 day (d).

Note:

For the constraints for the motor outputs specified here, see page 6/8.

1
3
0
1

At 40 °C			At 50 °C			SD ¹⁾	Article No.	Price per PU	PU (UNIT, SET, M)	PS*	PG	
Operational current	Operating power for three-phase motors		Operational current	Rating [hp] for three-phase motors								
	At 230 V	At 400 V		At 200/208 V	At 220/230 V	At 460/480 V	d					
A	kW	kW	A	hp	hp	hp						
Operational voltage 200 ... 480 V												
113	30	55	101	30	30	75	5	3RW5534-□HF□4		1	1 unit	42S
143	37	75	128	40	40	100	5	3RW5535-□HF□4		1	1 unit	42S
171	45	90	153	50	50	100	5	3RW5536-□HF□4		1	1 unit	42S
210	55	110	186	60	60	150	5	3RW5543-□HF□4		1	1 unit	42S
250	75	132	220	60	75	150	5	3RW5544-□HF□4		1	1 unit	42S
315	90	160	279	75	100	200	5	3RW5545-□HF□4		1	1 unit	42S
370	110	200	328	100	125	250	5	3RW5546-□HF□4		1	1 unit	42S
470	132	250	416	150	150	350	5	3RW5547-□HF□4		1	1 unit	42S
570	160	315	504	150	200	400	5	3RW5548-□HF□4		1	1 unit	42S

Type of electrical connection for the control circuit

Spring-loaded terminals

Screw terminals

Control supply voltage

24 V AC/DC

110 ... 250 V AC

¹⁾ 3RW55 soft starter with screw terminals for operational voltage up to 480 V: Standard delivery time SD = 1 day (d).

Note:

For the constraints for the motor outputs specified here, see page 6/8.

2
6
0
1

Switching devices – Soft starters and solid-state switching devices

SIRIUS 3RW soft starters

High Performance soft starters

IE3/IE4 ready

3RW55 Failsafe soft starters > Inside-delta circuit

Selection and ordering data

For normal starting (CLASS 10E)



3RW551.1



3RW552.2



3RW553.3



3RW554.4

At 40 °C for inside-delta circuit			At 50 °C for inside-delta circuit			SD ¹⁾	Article No.	Price per PU	PU (UNIT, SET, M)	PS*	PG
Operational current	Operating power for three-phase motors		Operational current	Rating [hp] for three-phase motors							
	At 230 V	At 400 V		At 200/208 V	At 220/230 V	At 460/480 V	d				
A	kW	kW	A	hp	hp	hp					
Operational voltage 200 ... 480 V											
22.5	5.5	11	19.9	5	5	10	5	3RW5513-□HF□4	1	1 unit	42S
31.5	7.5	15	28	7.5	7.5	20	5	3RW5514-□HF□4	1	1 unit	42S
43.3	11	18.5	39	10	10	25	5	3RW5515-□HF□4	1	1 unit	42S
55.4	15	22	49	15	15	30	5	3RW5516-□HF□4	1	1 unit	42S
65.8	18.5	30	58	15	20	40	5	3RW5517-□HF□4	1	1 unit	42S
81.4	22	45	72	20	25	50	5	3RW5524-□HF□4	1	1 unit	42S
109	30	55	96	30	30	75	5	3RW5525-□HF□4	1	1 unit	42S
133	37	75	118	30	40	75	5	3RW5526-□HF□4	1	1 unit	42S
161	45	90	143	40	50	100	5	3RW5527-□HF□4	1	1 unit	42S

Type of electrical connection for the control circuit

Screw terminals
Spring-loaded terminals

Control supply voltage

24 V AC/DC
110 ... 250 V AC

¹⁾ 3RW55 soft starter with screw terminals for operational voltage up to 480 V:
Standard delivery time SD = 1 day (d).

Note:

For the constraints for the motor outputs specified here, see page 6/8.

At 40 °C for inside-delta circuit			At 50 °C for inside-delta circuit			SD ¹⁾	Article No.	Price per PU	PU (UNIT, SET, M)	PS*	PG
Operational current	Operating power for three-phase motors		Operational current	Rating [hp] for three-phase motors							
	At 230 V	At 400 V		At 200/208 V	At 220/230 V	At 460/480 V	d				
A	kW	kW	A	hp	hp	hp					
Operational voltage 200 ... 480 V											
196	55	110	175	50	60	125	5	3RW5534-□HF□4	1	1 unit	42S
248	75	132	222	75	75	150	5	3RW5535-□HF□4	1	1 unit	42S
296	90	160	265	75	100	200	5	3RW5536-□HF□4	1	1 unit	42S
364	110	200	322	100	125	250	5	3RW5543-□HF□4	1	1 unit	42S
433	132	250	381	125	150	300	5	3RW5544-□HF□4	1	1 unit	42S
546	160	315	483	150	200	400	5	3RW5545-□HF□4	1	1 unit	42S
641	200	355	568	200	200	450	5	3RW5546-□HF□4	1	1 unit	42S
814	250	400	721	250	250	600	5	3RW5547-□HF□4	1	1 unit	42S
987	315	560	873	300	350	750	5	3RW5548-□HF□4	1	1 unit	42S

Type of electrical connection for the control circuit

Spring-loaded terminals
Screw terminals

Control supply voltage

24 V AC/DC
110 ... 250 V AC

¹⁾ 3RW55 soft starter with screw terminals for operational voltage up to 480 V:
Standard delivery time SD = 1 day (d).

Note:

For the constraints for the motor outputs specified here, see page 6/8.

Switching devices – Soft starters and solid-state switching devices

SIRIUS 3RW soft starters

High Performance soft starters

3RW55 Failsafe soft starters > Accessories

Selection and ordering data

Product designation	Manufacturer's Article No. of the soft starter	Type of product	Application	SD	Article No.	Price per PU	PU (UNIT, SET, M)	PS*	PG	
Fan covers										
	Fan cover	3RW551 (1x), 3RW552 (2x), 3RW553 (2x)	--	--	▶	3RW5983-0FC00		1	1 unit	42S
		3RW554 (1x)	--	--	▶	3RW5984-0FC00		1	1 unit	42S
3RW5983-0FC00										
Terminal covers										
	Terminal cover	3RW552 (2x), 3RW553 (2x)	--	--	▶	3RW5983-0TC20		1	1 unit	42S
		3RW554 (2x)	--	--	▶	3RW5984-0TC20		1	1 unit	42S
3RW5983-0TC20										
3RW5984-0TC20										
Enclosure components										
	Hinged cover	3RW55	Without cutout	--	▶	3RW5950-0GL20		1	1 unit	42S
3RW5950-0GL20										
Communication modules										
	Communication module	3RW55	PROFINET High Feature with integral switch	--	▶	3RW5950-0CH00		1	1 unit	42S
			PROFINET Standard	--	▶	3RW5980-0CS00		1	1 unit	42S
			PROFIBUS	--	▶	3RW5980-0CP00		1	1 unit	42S
3RW5980-0CS00										
			EtherNet/IP	--	▶	3RW5980-0CE00		1	1 unit	42S
			Modbus RTU	--	▶	3RW5980-0CR00		1	1 unit	42S
3RW5980-0CE00										
			Modbus TCP	--	▶	3RW5980-0CT00		1	1 unit	42S
3RW5980-0CR00										



* You can order this quantity or a multiple thereof. Illustrations are approximate

Switching devices – Soft starters and solid-state switching devices

SIRIUS 3RW soft starters

High Performance soft starters

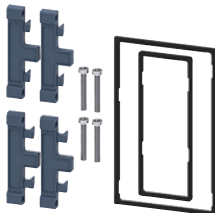
3RW55 Failsafe soft starters > Accessories

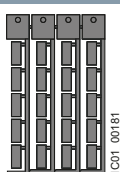
Product designation	Manufacturer's Article No. of the soft starter	Type of product	Application	SD	Article No.	Price per PU	PU (UNIT, SET, M)	PS*	PG	
HMI modules										
	IP65 door mounting kit for HMI modules	3RW55	IP65	For HMI modules	▶	3RW5980-0HD00		1	1 unit	42S
3RW5980-0HD00										
Connecting cables										
	HMI connecting cable	3RW55	5 m, round	For door mounting	▶	3RW5980-0HC60		1	1 unit	42S
		2.5 m, round	▶		3UF7933-0BA00-0		1	1 unit	42J	
		1.0 m, round	▶		3UF7937-0BA00-0		1	1 unit	42J	
		0.5 m, round	▶		3UF7932-0BA00-0		1	1 unit	42J	
3UF793.-0BA00-0										
Further accessories										
	Push-in lugs for wall mounting	--	Two lugs are required per device	For HMI modules and communication modules	2	3ZY1311-0AA00		1	10 units	41L
3ZY1311-0AA00										
Blank labels										
	Unit labeling plates¹⁾	--	20 mm x 7 mm, titanium gray	For SIRIUS devices	20	3RT2900-1SB20		100	340 units	41B
3RT2900-1SB20										

¹⁾ PC labeling systems for individual inscription of unit labeling plates are available from: murrplastik Systemtechnik GmbH (see page 16/16).

Switching devices – Soft starters and solid-state switching devices

SIRIUS 3RW soft starters

General Performance soft starters

3RW52 soft starters > General data

Overview

More information

Homepage, see www.siemens.com/sirius-soft-starter
 Industry Mall, see www.siemens.com/product?3RW52
 TIA Selection Tool Cloud (TST Cloud), see <https://www.siemens.com/tstcloud/?node=3rw52>
 Industry Online Support (SIOS) topic page, see <https://support.industry.siemens.com/cs/ww/en/view/109747404>

Simulation Tool for Soft Starters (STS), see page 6/9 or <https://support.industry.siemens.com/cs/ww/en/view/101494917>
 SIRIUS Soft Starter ES (TIA Portal) for diagnostics, see page 6/9 or <https://support.industry.siemens.com/cs/ww/en/ps/24230/dl>
 SIRIUS 3RW Soft Starter block library for SIMATIC PCS 7, see page 6/9 or <https://support.industry.siemens.com/cs/ww/en/view/109770336>



SIRIUS 3RW52 soft starters device family

SIRIUS 3RW52 General Performance soft starters are the ideal solution for standard applications. With ideal 3-phase motor control, they cover the performance range from 5.5 kW to 560 kW (at 400 V).

Optional HMI modules, plug-in communication modules (PROFINET, PROFIBUS, EtherNet/IP and Modbus) and either an analog output or thermistor motor protection ensure maximum flexibility.

With their modern hybrid switching technology, the SIRIUS 3RW52 soft starters offer efficient switching for long-term, energy-saving use.

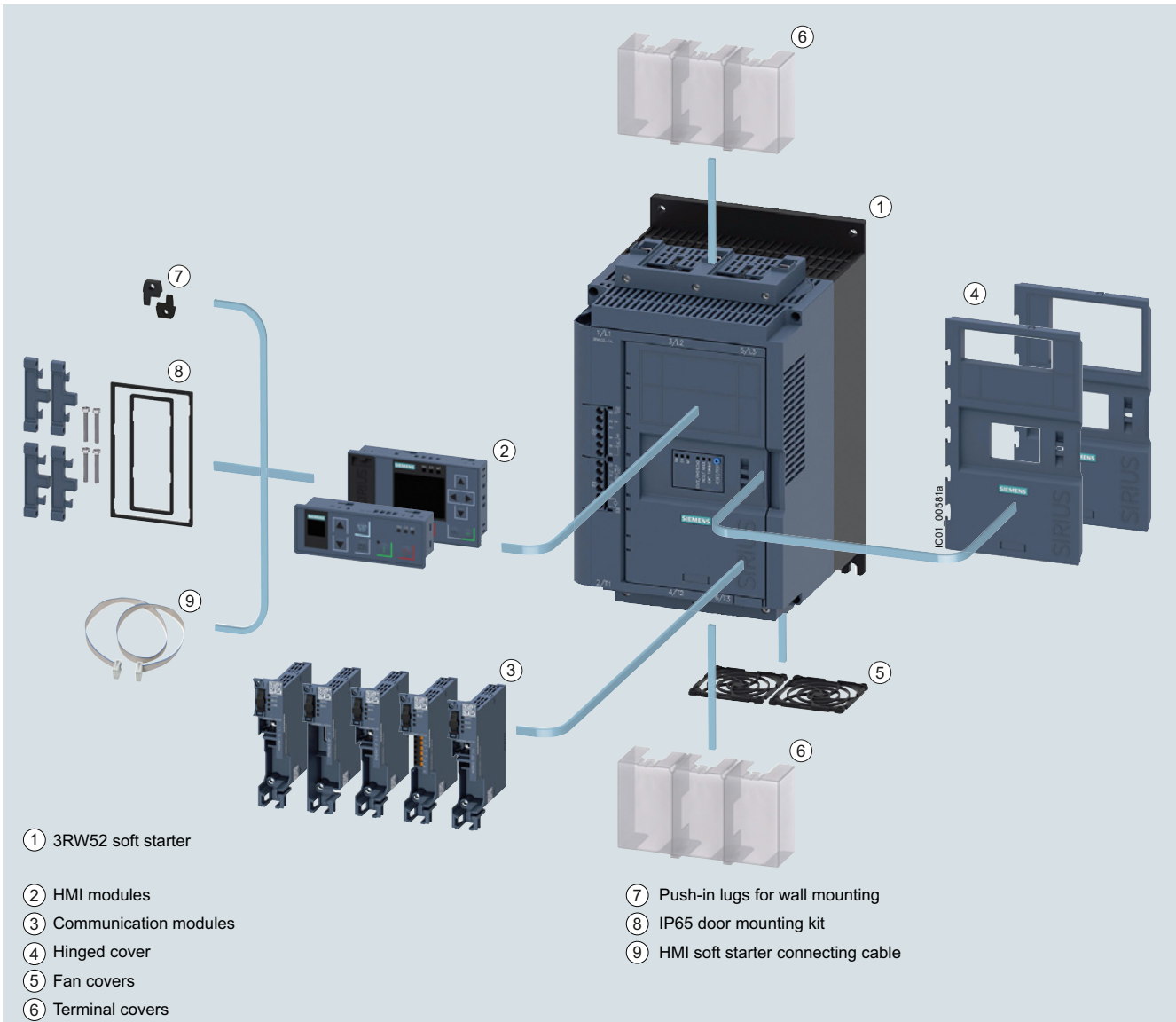

① 3RW52 soft starter

② HMI modules

③ Communication modules

④ Hinged cover

⑤ Fan covers

⑥ Terminal covers

⑦ Push-in lugs for wall mounting

⑧ IP65 door mounting kit

⑨ HMI soft starter connecting cable

SIRIUS 3RW52 General Performance soft starter with accessories (see page 6/70), for expansion with HMI module or communication module

Switching devices – Soft starters and solid-state switching devices

SIRIUS 3RW soft starters
General Performance soft starters

3RW52 soft starters > General data

Benefits

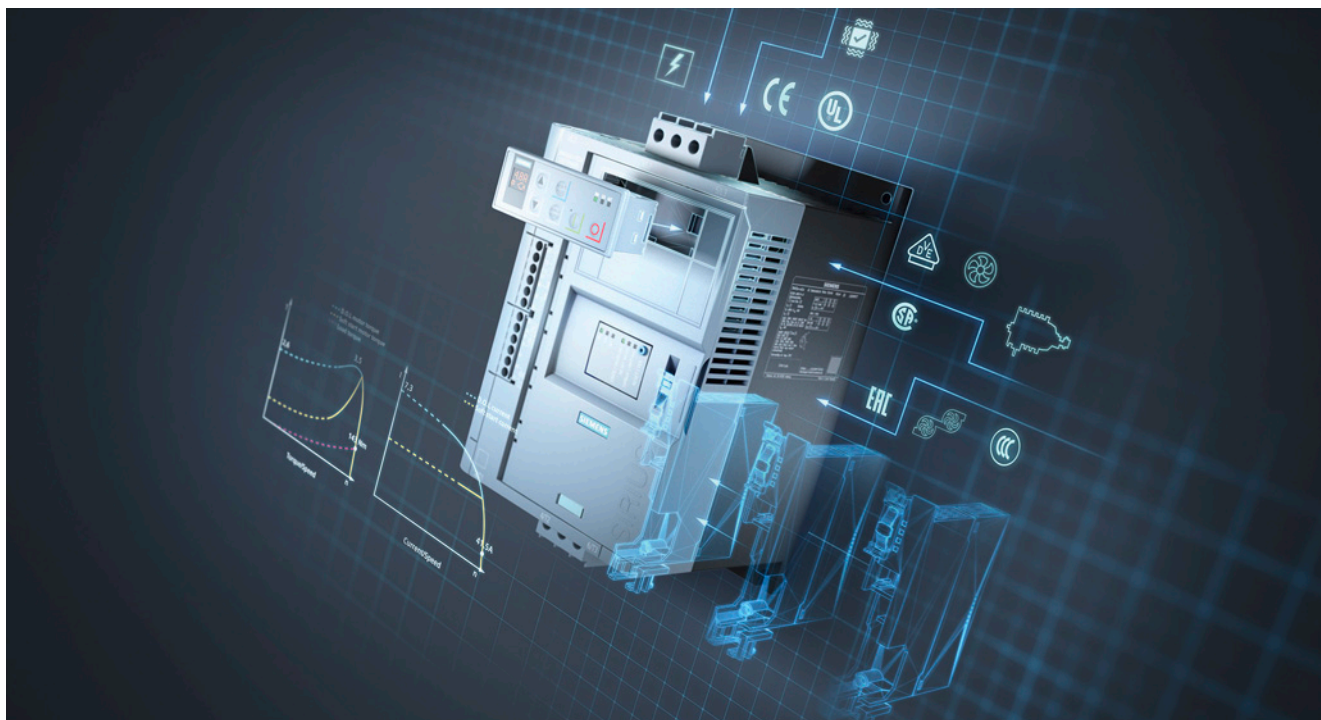

Product characteristics / function	Performance features / benefits
Hybrid switching technology and 3-phase motor control	Minimum power loss and optimum/symmetrical motor control
TIA integration – communication modules and HMI modules optional	Efficient configuration and maximum flexibility in automation engineering
Soft Torque	Reduced mechanical loading and optimum pump stop
Parameterization using potentiometers	Simple and fast commissioning
Wide range for control supply and main voltage	Low variance, high system availability even with weak supply networks

Switching devices – Soft starters and solid-state switching devices

SIRIUS 3RW soft starters

General Performance soft starters

3RW52 soft starters > General data

Technical specifications

More information

Technical specifications, see
<https://support.industry.siemens.com/cs/ww/en/ps/25100/td>
 Equipment Manual, see
<https://support.industry.siemens.com/cs/ww/en/view/109753751>

FAQs, see <https://support.industry.siemens.com/cs/ww/en/ps/25100/faq>
 Simulation Tool for Soft Starters (STS), see page 6/9 or
<https://support.industry.siemens.com/cs/ww/en/view/101494917>

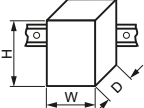
Type	3RW5213 3RW5214 3RW5215	3RW5216 3RW5217	3RW5224 3RW5225	3RW5226 3RW5227 3RW5234 3RW5235 3RW5236	3RW5243 3RW5244 3RW5245 3RW5246 3RW5247 3RW5248
Installation/fixing/dimensions					
Width x height x depth		mm 170 × 275 × 152	185 × 306 × 203	210 × 393 × 203	
Type of mounting	Screw fixing				
Mounting position	For vertical mounting surface can be rotated +/- 10° and tilted forward or backward	For vertical mounting surface can be rotated +/- 90°, for vertical mounting surface can be tilted +/- 22.5° forward or backward	For vertical mounting surface can be rotated +/- 10° and tilted forward or backward	For vertical mounting surface can be rotated +/- 90°, for vertical mounting surface can be tilted +/- 22.5° forward or backward	
Distance to be maintained with side-by-side mounting					
• Above	mm	100			
• At the side	mm	5			
• Below	mm	75			
Maximum installation altitude above sea level¹⁾	m	5 000			
Degree of protection IP on the front acc. to IEC 60529	IP20		IP00 (IP20 with cover)		
Touch protection on the front acc. to IEC 60529	Finger-safe for vertical touching from the front		Finger-safe for vertical touching from the front with cover		
Ambient conditions					
Ambient temperature					
• During operation ²⁾	°C	-25 ... +60			
• During storage and transport	°C	-40 ... +80			
Environmental category according to IEC 60721					
• During operation	3K6 (no ice formation, only occasional condensation), 3C3 (no salt mist), 3S2 (sand must not get into the devices), 3M6				
• During storage	1K6 (only occasional condensation), 1C2 (no salt mist), 1S2 (sand must not get into the devices), 1M4				
• During transport	2K2, 2C1, 2S1, 2M2 (max. height of fall 0.3 m)				

¹⁾ Derating from 1 000 m, see characteristic curve on page 6/8.

²⁾ Note derating above 40 °C.

Switching devices – Soft starters and solid-state switching devices

SIRIUS 3RW soft starters General Performance soft starters

3RW52 soft starters > General data

Type		3RW52...-C0.	3RW52...-C1.
Control circuit/control			
Control supply voltage			
• At AC/DC	V	24/24	--/--
• At AC	V	--	110 ... 250
• Relative negative tolerance/relative positive tolerance with AC	%	-20/20	-15/10
• Relative negative tolerance/relative positive tolerance with DC	%	-20/20	--/--
Frequency of the control supply voltage			
• Relative negative tolerance/relative positive tolerance	Hz	50 ... 60	
	%	-10/10	
Type of overvoltage protection			
Varistors			
Type of short-circuit protection for control circuit¹⁾			
Fuse 4 A gG ($I_{cu} = 1 \text{ kA}$), fuse 6 A quick-response ($I_{cu} = 1 \text{ kA}$), MCB C1 ($I_{cu} = 600 \text{ A}$), MCB C6 ($I_{cu} = 300 \text{ A}$)			

¹⁾ Not included in scope of supply

Type		3RW52...-C.4	3RW52...-C.5
Power electronics			
Operational voltage, rated value			
• Relative negative tolerance/relative positive tolerance	V	200 ... 480	200 ... 600
	%	-15/10	
Operational voltage for inside-delta circuit, rated value			
• Relative negative tolerance/relative positive tolerance	V	200 ... 480	200 ... 600
	%	-15/10	
Operating frequency			
• Relative negative tolerance/relative positive tolerance	Hz	50 ... 60	
	%	-10/10	
Minimum load [% of I_M]¹⁾			
	%	15	
Maximum cable length between soft starter and motor			
	m	800	

¹⁾ Relative to the smallest adjustable I_e .

Switching devices – Soft starters and solid-state switching devices

SIRIUS 3RW soft starters

General Performance soft starters

3RW52 soft starters > General data

Type		3RW5213	3RW5214	3RW5215	3RW5216	3RW5217
Rated operational current I_e	A	13	18	25	32	38
Power electronics						
Load rating with rated operational current I_e						
IEC + UL/CSA, individual mounting at 40/50/60 °C, A AC-53a	A	13/11.5/10.5	18/15.9/13.8	25/22.3/19.6	32/28.4/26	38/33.5/30.5
Permissible rated motor current and starts/h						
Normal starting (CLASS 10A)						
Rated motor current I_M , $T_u = 40/50/60$ °C ON period = 70%; motor protection activated	A	13/11.5/10.5	18/15.9/13.8	25/22.3/19.6	32/28.4/26	38/33.5/30.5
• 300% I_M						
- Start-up time 5 s	1/h	43	43	43	43	43
- Start-up time 10 s	1/h	18	18	18	18	18
• 350% I_M						
- Start-up time 5 s	1/h	28	28	28	28	28
- Start-up time 10 s	1/h	10	10	10	10	10
Normal starting (CLASS 10E)						
Rated motor current I_M , $T_u = 40/50/60$ °C ON period = 70%; motor protection activated	A	13/11.5/10.5	18/15.9/13.8	25/22.3/19.6	32/28.4/26	38/33.5/30.5
• 300% I_M						
- Start-up time 10 s	1/h	21	21	21	21	21
- Start-up time 20 s	1/h	8	8	8	8	8
• 350% I_M						
- Start-up time 10 s	1/h	13	13	13	13	13
- Start-up time 20 s	1/h	4	4	4	4	4
Heavy starting (CLASS 20E)						
Rated motor current I_M , $T_u = 40/50/60$ °C ON period = 70%; motor protection activated	A	13/11.5/10.5	18/15.9/13.8	25/22.3/19.6	29.6/27.2/23.6	33.5/30.5/27.5
• 300% I_M						
- Start-up time 20 s	1/h	10	10	10	10	10
- Start-up time 40 s	1/h	4	4	4	4	4
• 350% I_M						
- Start-up time 20 s	1/h	7	7	7	7	7
- Start-up time 40 s	1/h	2.5	2.5	2.5	2.5	2.5
Adjustable rated motor current I_M						
• Minimum/maximum	A	5.5/13	7.5/18	11.5/25	14/32	15.5/38
• Minimum/maximum in inside-delta circuits	A	9.5/22.5	13/31.2	19.9/43.3	24.2/55.4	26.8/65.8

Switching devices – Soft starters and solid-state switching devices

SIRIUS 3RW soft starters
General Performance soft starters

3RW52 soft starters > General data

Type		3RW5224	3RW5225	3RW5226	3RW5227
Rated operational current I_e	A	47	63	77	93
Power electronics					
Load rating with rated operational current I_e					
IEC + UL/CSA, individual mounting at 40/50/60 °C, A AC-53a	A	47/41.6/36.2	63/55.5/50.5	77/68/62	93/82.5/75.5
Permissible rated motor current and starts/h					
Normal starting (CLASS 10A)					
Rated motor current I_M , $T_u = 40/50/60$ °C ON period = 70%; motor protection activated	A	47/41.6/36.2	63/55.5/50.5	77/68/62	93/82.5/75.5
• 300% I_M					
- Start-up time 5 s	1/h	43	43	43	43
- Start-up time 10 s	1/h	18	18	18	18
• 350% I_M					
- Start-up time 5 s	1/h	28	28	28	28
- Start-up time 10 s	1/h	10	10	10	10
Normal starting (CLASS 10E)					
Rated motor current I_M , $T_u = 40/50/60$ °C ON period = 70%; motor protection activated	A	47/41.6/36.2	63/55.5/50.5	77/68/62	93/82.5/75.5
• 300% I_M					
- Start-up time 10 s	1/h	21	21	21	21
- Start-up time 20 s	1/h	8	8	8	8
• 350% I_M					
- Start-up time 10 s	1/h	13	13	13	13
- Start-up time 20 s	1/h	4	4	4	4
Heavy starting (CLASS 20E)					
Rated motor current I_M , $T_u = 40/50/60$ °C ON period = 70%; motor protection activated	A	47/41.6/36.2	63/55.5/50.5	65/59/53	93/82.5/75.5
• 300% I_M					
- Start-up time 20 s	1/h	10	10	10	10
- Start-up time 40 s	1/h	4	3	4	4
• 350% I_M					
- Start-up time 20 s	1/h	7	4	7	7
- Start-up time 40 s	1/h	2	0	2.5	2.5
Adjustable rated motor current I_M					
• Minimum/maximum	A	20/47	25.5/63	32/77	40.5/93
• Minimum/maximum in inside-delta circuits	A	34.6/81.4	44.2/109	55.4/133	70.1/161

Switching devices – Soft starters and solid-state switching devices

SIRIUS 3RW soft starters

General Performance soft starters

3RW52 soft starters > General data

Type		3RW5234	3RW5235	3RW5236
Rated operational current I_e	A	113	143	171
Power electronics				
Load rating with rated operational current I_e				
IEC + UL/CSA, individual mounting at 40/50/60 °C, AC-53a	A	113/101/89	143/128/118	171/153/141
Permissible rated motor current and starts/h				
Normal starting (CLASS 10A)				
Rated motor current I_M , $T_u = 40/50/60$ °C ON period = 70%; motor protection activated	A	113/101/89	143/128/118	171/153/141
• 300% I_M				
- Start-up time 5 s	1/h	43	43	43
- Start-up time 10 s	1/h	18	18	18
• 350% I_M				
- Start-up time 5 s	1/h	28	27	20
- Start-up time 10 s	1/h	10	8	4
Normal starting (CLASS 10E)				
Rated motor current I_M , $T_u = 40/50/60$ °C ON period = 70%; motor protection activated	A	113/101/89	139/127/116	158/146/129
• 300% I_M				
- Start-up time 10 s	1/h	21	21	21
- Start-up time 20 s	1/h	8	8	8
• 350% I_M				
- Start-up time 10 s	1/h	13	12	12
- Start-up time 20 s	1/h	4	1	1
Heavy starting (CLASS 20E)				
Rated motor current I_M , $T_u = 40/50/60$ °C ON period = 70%; motor protection activated	A	109/97/85	113/103/93	129/117/105
• 300% I_M				
- Start-up time 20 s	1/h	10	10	10
- Start-up time 40 s	1/h	4	4	4
• 350% I_M				
- Start-up time 20 s	1/h	7	7	7
- Start-up time 40 s	1/h	2.5	2.5	2.5
Adjustable rated motor current I_M				
• Minimum/maximum	A	53/113	68/143	81/171
• Minimum/maximum in inside-delta circuits	A	91.8/196	118/248	140/296

Switching devices – Soft starters and solid-state switching devices

SIRIUS 3RW soft starters

General Performance soft starters

3RW52 soft starters > General data

Type		3RW5243	3RW5244	3RW5245	3RW5246	3RW5247	3RW5248
Rated operational current I_e	A	210	250	315	370	470	570
Power electronics							
Load rating with rated operational current I_e							
IEC + UL/CSA, individual mounting at 40/50/60 °C, A AC-53a	A	210/186/170	250/220/200	315/279/255	370/328/300	470/416/380	570/504/460
Permissible rated motor current and starts/h							
Normal starting (CLASS 10A)							
Rated motor current I_M , $T_u = 40/50/60$ °C ON period = 70%; motor protection activated	A	210/186/170	250/220/200	315/279/255	370/328/300	470/416/380	570/504/460
• 300% I_M							
- Start-up time 5 s	1/h	43	43	43	43	30	20
- Start-up time 10 s	1/h	18	18	14	18	11	6
• 350% I_M							
- Start-up time 5 s	1/h	28	28	16	28	17	9
- Start-up time 10 s	1/h	5	10	4	10	5	1
Normal starting (CLASS 10E)							
Rated motor current I_M , $T_u = 40/50/60$ °C ON period = 70%; motor protection activated	A	197/184/170	250/220/200	279/255/231	370/328/300	398/362/326	460/416/372
• 300% I_M							
- Start-up time 10 s	1/h	21	21	21	21	21	18
- Start-up time 20 s	1/h	8	8	8	8	8	7
• 350% I_M							
- Start-up time 10 s	1/h	12	13	12	13	13	11
- Start-up time 20 s	1/h	1	4	3	4	4	2
Heavy starting (CLASS 20E)							
Rated motor current I_M , $T_u = 40/50/60$ °C ON period = 70%; motor protection activated	A	162/146/130	200/180/160	195/171/147	258/230/202	272/236/218	284/262/240
• 300% I_M							
- Start-up time 20 s	1/h	10	10	10	10	10	10
- Start-up time 40 s	1/h	4	4	4	4	4	4
• 350% I_M							
- Start-up time 20 s	1/h	7	7	7	7	7	7
- Start-up time 40 s	1/h	2.5	2.5	2.5	2.5	2.5	2.5
Adjustable rated motor current I_M							
• Minimum/maximum	A	90/210	100/250	135/315	160/370	200/470	240/570
• Minimum/maximum in inside-delta circuits	A	156/364	173/433	234/546	277/641	346/814	416/987

Switching devices – Soft starters and solid-state switching devices

SIRIUS 3RW soft starters

General Performance soft starters

3RW52 soft starters > General data

Motor feeders according to IEC with 3RV2 motor starter protectors or 3VA circuit breakers (without semiconductor protection)

Type of coordination "1", CLASS 10,
short-circuit breaking capacity I_q in kA, [see table](#)

Note:

For general recommendations for constructing motor feeders
with soft starters, [see page 6/11](#).

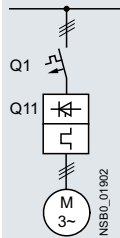

Motor starter protectors

for 400 V systems

Q1

Type

I_q
kA

for 500 V systems

Q1

Type

I_q
kA

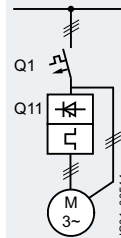

Motor starter protectors

for 400 V systems

Q1

Type

I_q
kA

for 500 V systems

Q1

Type

I_q
kA

Type of coordination

1

Inline circuit

Inside-delta circuit

Soft starters	Motor starter protectors for 400 V systems	I_q kA	Motor starter protectors for 500 V systems	I_q kA	Motor starter protectors for 400 V systems	I_q kA	Motor starter protectors for 500 V systems	I_q kA
Q11 Type	Q1 Type		Q1 Type		Q1 Type		Q1 Type	
3RW5213	3RV2032-4TA10	65	3RV2032-4TA10	18	3RV2032-4DA10	65	3RV2032-4DA10	18
3RW5214	3RV2032-4DA10	65	3RV2032-4DA10	15	3RV2032-4EA10	65	3RV2032-4EA10	15
3RW5215	3RV2032-4EA10	65	3RV2032-4EA10	15	3RV2032-4VA10	65	3RV2032-4VA10	15
3RW5216	3RV2032-4VA10	65	3RV2032-4VA10	10	3RV2032-4JA10	65	3RV2032-4JA10	10
3RW5217	3RV2032-4WA10	65	3RV2032-4WA10	10	3RV2032-4RA10	65	3RV2032-4RA10	10
3RW5224	3RV2032-4JA10	65	3RV2032-4JA10	10	3RV2032-4RA10	65	3RV2032-4RA10	10
3RW5225	3VA2163-7MN32-0AA0	65	3VA2163-7MN32-0AA0	20	3VA2110-7MN32-0AA0	65	3VA2110-7MN32-0AA0	20
3RW5226	3VA2110-7MN32-0AA0	65	3VA2110-7MN32-0AA0	20	3VA2216-7MN32-0AA0	65	3VA2216-7MN32-0AA0	20
3RW5227	3VA2216-7MN32-0AA0	15	3VA2216-7MN32-0AA0	10	3VA2220-7MN32-0AA0	15	3VA2220-7MN32-0AA0	10
3RW5234	3VA2216-7MN32-0AA0	65	--	--	3VA2220-7MN32-0AA0	65	--	--
3RW5235	3VA2220-7MN32-0AA0	65	--	--	3VA2325-7MN32-0AA0	65	--	--
3RW5236	3VA2325-7MN32-0AA0	30	3VA2325-7MN32-0AA0	10	3VA2440-7MN32-0AA0	30	3VA2440-7MN32-0AA0	10
3RW5243	3VA2325-7MN32-0AA0	65	3VA2325-7MN32-0AA0	65	3VA2440-7MN32-0AA0	65	3VA2440-7MN32-0AA0	65
3RW5244	3VA2440-7MN32-0AA0	65	3VA2440-7MN32-0AA0	65	3VA2450-7MN32-0AA0	65	3VA2450-7MN32-0AA0	65
3RW5245	3VA2440-7MN32-0AA0	65	3VA2440-7MN32-0AA0	65	3VA2580-6HN32-0AA0	65	3VA2580-6HN32-0AA0	65
3RW5246	3VA2440-7MN32-0AA0	65	3VA2440-7MN32-0AA0	65	3VA2580-6HN32-0AA0	65	3VA2580-6HN32-0AA0	65
3RW5247	3VA2450-7MN32-0AA0	65	3VA2450-7MN32-0AA0	65	3VA2510-6HN32-0AA0	65	3VA2510-6HN32-0AA0	65
3RW5248	3VA2580-6HN32-0AA0	65	3VA2580-6HN32-0AA0	65	3VA2510-6HN32-0AA0	65	3VA2510-6HN32-0AA0	65

Note:

The service factor and measurement inaccuracies, for example, have been taken into account for the selection of the specified motor starter protectors/circuit breakers; the specified short-circuit breaking capacities I_q in kA are covered by combination tests. Smaller motor starter protectors/circuit breakers from the same series can be used at any time as smaller ones trip more quickly in the event of a short circuit (unchanged short-circuit breaking capacity) and thus protect the soft starter in any case. The dimensioning of the short-circuit components must match the connected three-phase motor, the short-circuit and overload requirements of the application, and the line protection for the cables used.

Switching devices – Soft starters and solid-state switching devices

SIRIUS 3RW soft starters
General Performance soft starters

3RW52 soft starters > General data

Motor feeders according to IEC with 3NA3 fuses

gG class full-range fuses for cable and line protection according to IEC 60269-2, without semiconductor protection

Type of coordination "1",
short-circuit breaking capacity $I_{q} = 65 \text{ kA}$

Note:

For general recommendations for constructing motor feeders with soft starters, [see page 6/11](#).

Soft starters	gG class fuse			Line contactor (optional)		gG class fuse			Line contactor (optional)	
	for systems up to 600 V	for systems up to 480 V	for systems up to 600 V	for systems up to 480 V in the supply cable	for systems up to 600 V in the supply cable	for systems up to 480 V in the delta	for systems up to 600 V in the delta			
Q11 Type	F1 Type	Q21 Type	Q21 Type	F1 Type	Q21 Type	Q21 Type	Q21 Type	Q21 Type		
Type of coordination "1"	Inline circuit			Inside-delta circuit						
3RW5213	3NA3820-6	3RT2025	3RT2025	3NA3820-6	3RT2027	3RT2035	3RT2025	3RT2025		
3RW5214	3NA3820-6	3RT2026	3RT2027	3NA3820-6	3RT2027	3RT2037	3RT2026	3RT2027		
3RW5215	3NA3822-6	3RT2027	3RT2037	3NA3822-6	3RT2036	3RT2037	3RT2027	3RT2037		
3RW5216	3NA3824-6	3RT2035	3RT2037	3NA3824-6	3RT2037	3RT2038	3RT2035	3RT2037		
3RW5217	3NA3824-6	3RT2035	3RT2037	3NA3824-6	3RT2038	3RT2046	3RT2035	3RT2037		
3RW5224	3NA3824-6	3RT2036	3RT2037	3NA3824-6	3RT2046	3RT2047	3RT2036	3RT2037		
3RW5225	3NA3830-6	3RT2037	3RT2046	3NA3830-6	3RT2047	3RT1054	3RT2037	3RT2046		
3RW5226	3NA3132-6	3RT2038	3RT2046	3NA3132-6	3RT1055	3RT1055	3RT2038	3RT2046		
3RW5227	3NA3136-6	3RT2046	3RT2047	3NA3136-6	3RT1056	3RT1056	3RT2046	3RT2047		
3RW5234	3NA3244-6	3RT1054	3RT1054	3NA3244-6	3RT1064	3RT1064	3RT1054	3RT1054		
3RW5235	3NA3244-6	3RT1055	3RT1055	3NA3244-6	3RT1065	3RT1065	3RT1055	3RT1055		
3RW5236	3NA3365-6	3RT1056	3RT1064	3NA3365-6	3RT1066	3RT1075	3RT1056	3RT1064		
3RW5243	2 x 3NA3354-6	3RT1064	3RT1064	2 x 3NA3354-6	3RT1075	3RT1075	3RT1064	3RT1064		
3RW5244	2 x 3NA3354-6	3RT1065	3RT1065	2 x 3NA3354-6	3RT1076	3RT1076	3RT1065	3RT1065		
3RW5245	2 x 3NA3365-6	3RT1075	3RT1075	2 x 3NA3365-6	3TF68	3TF68	3RT1075	3RT1075		
3RW5246	2 x 3NA3365-6	3RT1075	3RT1075	2 x 3NA3365-6	3TF69	3TF69	3RT1075	3RT1075		
3RW5247	2 x 3NA3365-6	3RT1076	3RT1276	2 x 3NA3365-6	3TF69	3TF69	3RT1076	3RT1276		
3RW5248	2 x 3NA3365-6	3TF68	3TF68	2 x 3NA3365-6	--	--	3TF68	3TF68		

Note:

The specified short-circuit breaking capacities I_{q} in kA are covered by combination tests. Smaller fuses than those specified can be used at any time as smaller ones trip more quickly in the event of a short circuit (unchanged short-circuit breaking capacity) and thus protect the soft starter in any case. The dimensioning of the short-circuit components must, however, be suitable for the connected three-phase motor and the line protection for the cables used.

Switching devices – Soft starters and solid-state switching devices

SIRIUS 3RW soft starters

General Performance soft starters

3RW52 soft starters > General data

Motor feeders according to IEC with 3NE1 SITOR fuses

gR class full-range fuses for semiconductor protection, cable and line protection

Type of coordination "2",
short-circuit breaking capacity $I_{q} = 65 \text{ kA}$

Note:

For general recommendations for constructing motor feeders with soft starters, see page 6/11.

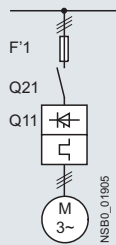

Soft starters	gR class fuse	Line contactor (optional)	
	for systems up to 600 V	for systems up to 480 V	for systems up to 600 V
Q11	F'1	Q21	Q21
Type	Type	Type	Type
Type of coordination "2"	Inline circuit		
	<small>toc 2</small>		
3RW5213	3NE1815-0	3RT2025	3RT2025
3RW5214	3NE1802-0	3RT2026	3RT2027
3RW5215	3NE1817-0	3RT2027	3RT2037
3RW5216	3NE1818-0	3RT2035	3RT2037
3RW5217	3NE1820-0	3RT2035	3RT2037
3RW5224	3NE1021-2	3RT2036	3RT2037
3RW5225	3NE1022-0	3RT2037	3RT2046
3RW5226	3NE1224-0	3RT2038	3RT2046
3RW5227	3NE1224-0	3RT2046	3RT2047
3RW5234	3NE1225-0	3RT1054	3RT1054
3RW5235	3NE1227-0	3RT1055	3RT1055
3RW5236	3NE1230-0	3RT1056	3RT1064
3RW5243	3NE1230-2 ¹⁾	3RT1064	3RT1064
3RW5244	3NE1331-0	3RT1065	3RT1065
3RW5245	3NE1334-2	3RT1075	3RT1075
3RW5246	3NE1334-2	3RT1075	3RT1075
3RW5247	3NE1436-2	3RT1076	3RT1276
3RW5248	3NE1437-2	3TF68	3TF68

¹⁾ For systems up to 500 V.

Note:

The specified short-circuit breaking capacities I_{q} in kA are covered by combination tests. Smaller fuses than those specified can be used at any time as smaller ones trip more quickly in the event of a short circuit (unchanged short-circuit breaking capacity) and thus protect the soft starter in any case. The dimensioning of the short-circuit components must, however, be suitable for the connected three-phase motor and the line protection for the cables used.

In inside-delta circuits, a gR class full-range fuse could not provide the semiconductor protection of the delta-connected soft starter with a short-circuit breaking capacity that is adequate for practical use. In this case, we recommend using aR class partial-range fuses for semiconductor protection for type of coordination "2" (see page 6/65).

Switching devices – Soft starters and solid-state switching devices

SIRIUS 3RW soft starters
General Performance soft starters

3RW52 soft starters > General data

Motor feeders according to IEC with fuses 3NE8 / 3NE4 / 3NE3

aR class partial-range fuses for semiconductor protection

Type of coordination "2",
short-circuit breaking capacity $I_{q1} = 65 \text{ kA}$ Note:For general recommendations for constructing motor feeders
with soft starters, [see page 6/11](#).

Soft starters	Inline circuit			Inside-delta circuit						
	gG class fuse	aR class fuse	Line contactor (optional)	gG class fuse	aR class fuse	Line contactor (optional)				
Q11 Type	for systems up to 600 V	for systems up to 500 V	for systems up to 480 V for systems up to 600 V	for systems up to 600 V	for systems up to 600 V	for systems up to 480 V in the supply cable	for systems up to 600 V in the supply cable	for systems up to 480 V in the delta	for systems up to 600 V in the delta	
Type of coordination "2"	Inline circuit			Inside-delta circuit						
3RW5213	3NA3820-6	3NE8017-1	3RT2025	3RT2025	3NA3820-6	3NE8017-1	3RT2027	3RT2035	3RT2025	3RT2025
3RW5214	3NA3820-6	3NE8020-1	3RT2026	3RT2027	3NA3820-6	3NE8020-1	3RT2027	3RT2037	3RT2026	3RT2027
3RW5215	3NA3822-6	3NE8021-1	3RT2027	3RT2037	3NA3822-6	3NE8021-1	3RT2036	3RT2037	3RT2027	3RT2037
3RW5216	3NA3824-6	3NE8022-1	3RT2035	3RT2037	3NA3824-6	3NE8022-1	3RT2037	3RT2038	3RT2035	3RT2037
3RW5217	3NA3824-6	3NE8024-1	3RT2035	3RT2037	3NA3824-6	3NE8024-1	3RT2038	3RT2046	3RT2035	3RT2037
3RW5224	3NA3824-6	3NE8024-1	3RT2036	3RT2037	3NA3824-6	3NE8024-1	3RT2046	3RT2047	3RT2036	3RT2037
3RW5225	3NA3830-6	3NE8024-1	3RT2037	3RT2046	3NA3830-6	3NE8024-1	3RT2047	3RT1054	3RT2037	3RT2046
3RW5226	3NA3132-6	3NE8024-1	3RT2038	3RT2046	3NA3132-6	3NE8024-1	3RT1055	3RT1055	3RT2038	3RT2046
3RW5227	3NA3136-6	3NE4124	3RT2046	3RT2047	3NA3136-6	3NE4124	3RT1056	3RT1056	3RT2046	3RT2047
3RW5234	3NA3244-6	3NE3332-0B	3RT1054	3RT1054	3NA3244-6	3NE3332-0B	3RT1064	3RT1064	3RT1054	3RT1054
3RW5235	3NA3244-6	3NE3334-0B	3RT1055	3RT1055	3NA3244-6	3NE3334-0B	3RT1065	3RT1065	3RT1055	3RT1055
3RW5236	3NA3365-6	3NE3335	3RT1056	3RT1064	3NA3365-6	3NE3335	3RT1066	3RT1075	3RT1056	3RT1064
3RW5243	2 x 3NA3354-6	3NE3333	3RT1064	3RT1064	2 x 3NA3354-6	3NE3333	3RT1075	3RT1075	3RT1064	3RT1064
3RW5244	2 x 3NA3354-6	3NE3336	3RT1065	3RT1065	2 x 3NA3354-6	3NE3336	3RT1076	3RT1076	3RT1065	3RT1065
3RW5245	2 x 3NA3365-6	3NE3336	3RT1075	3RT1075	2 x 3NA3365-6	3NE3336	3TF68	3TF68	3RT1075	3RT1075
3RW5246	2 x 3NA3365-6	3NE3336	3RT1075	3RT1075	2 x 3NA3365-6	3NE3336	3TF69	3TF69	3RT1075	3RT1075
3RW5247	2 x 3NA3365-6	3NE3340-8	3RT1076	3RT1276	2 x 3NA3365-6	3NE3340-8	3TF69	3TF69	3RT1076	3RT1276
3RW5248	2 x 3NA3365-6	3NE3340-8	3TF68	3TF68	2 x 3NA3365-6	3NE3340-8	--	--	3TF68	3TF68

Note:

The specified short-circuit breaking capacities I_{q1} in kA are covered by combination tests. Smaller fuses than those specified can be used at any time as smaller ones trip more quickly in the event of a short circuit (unchanged short-circuit breaking capacity) and thus protect the soft starter in any case. The dimensioning of the short-circuit components must, however, be suitable for the connected three-phase motor and the line protection for the cables used.

For CLASS 10 applications, as an alternative to the gG class full-range fuses for cable and line protection 3NA3 (F1), 3RV2 motor starter protectors or 3VA circuit breakers can also be used, possibly with reduced short-circuit breaking capacity ([see page 6/62](#)). In these cases, optional line contactors can be dispensed with.

Switching devices – Soft starters and solid-state switching devices

SIRIUS 3RW soft starters

General Performance soft starters

3RW52 soft starters > Inline circuit **IE3/IE4 ready**

Selection and ordering data

For normal starting (CLASS 10A)



3RW521.



3RW522.



3RW523.



3RW524.

At 40 °C				At 50 °C				SD ¹⁾	Article No.	Price per PU	PU (UNIT, SET, M)	PS*	PG
Operational current	Operating power for three-phase motors			Operational current	Rating [hp] for three-phase motors								
	At 230 V	At 400 V	At 500 V		At 200/208 V	At 220/230 V	At 460/480 V	At 575/600 V	d				
A	kW	kW	kW	A	hp	hp	hp	hp					
Operational voltage 200 ... 480 V													
13	3	5.5	--	11.5	2	3	7.5	--	5	3RW5213-□□C□4	1	1 unit	42S
18	4	7.5	--	15.9	3	5	10	--	5	3RW5214-□□C□4	1	1 unit	42S
25	5.5	11	--	22.3	5	7.5	15	--	5	3RW5215-□□C□4	1	1 unit	42S
32	7.5	15	--	28.4	7.5	10	20	--	5	3RW5216-□□C□4	1	1 unit	42S
38	11	18.5	--	33.5	10	10	20	--	5	3RW5217-□□C□4	1	1 unit	42S
47	11	22	--	41.6	10	10	30	--	5	3RW5224-□□C□4	1	1 unit	42S
63	18.5	30	--	55.5	15	20	40	--	5	3RW5225-□□C□4	1	1 unit	42S
77	22	37	--	68	20	25	50	--	5	3RW5226-□□C□4	1	1 unit	42S
93	22	45	--	82.5	25	30	60	--	5	3RW5227-□□C□4	1	1 unit	42S

Type of electrical connection for the control circuit

Screw terminals

Spring-loaded terminals

Product function

Analog output

Thermistor motor protection

Control supply voltage

24 V AC/DC

110 ... 250 V AC

¹⁾ 3RW52 soft starter with screw terminals for operational voltage up to 480 V:
Standard delivery time SD = 1 day (d).

Note:

For the constraints for the motor outputs specified here, see page 6/8.



At 40 °C				At 50 °C				SD ¹⁾	Article No.	Price per PU	PU (UNIT, SET, M)	PS*	PG
Operational current	Operating power for three-phase motors			Operational current	Rating [hp] for three-phase motors								
	At 230 V	At 400 V	At 500 V		At 200/208 V	At 220/230 V	At 460/480 V	At 575/600 V	d				
A	kW	kW	kW	A	hp	hp	hp	hp					
Operational voltage 200 ... 480 V													
113	30	55	--	101	30	30	75	--	5	3RW5234-□□C□4	1	1 unit	42S
143	37	75	--	128	40	40	100	--	5	3RW5235-□□C□4	1	1 unit	42S
171	45	90	--	153	50	50	100	--	5	3RW5236-□□C□4	1	1 unit	42S
210	55	110	--	186	60	60	150	--	5	3RW5243-□□C□4	1	1 unit	42S
250	75	132	--	220	60	75	150	--	5	3RW5244-□□C□4	1	1 unit	42S
315	90	160	--	279	75	100	200	--	5	3RW5245-□□C□4	1	1 unit	42S
370	110	200	--	328	100	125	250	--	5	3RW5246-□□C□4	1	1 unit	42S
470	132	250	--	416	150	150	350	--	5	3RW5247-□□C□4	1	1 unit	42S
570	160	315	--	504	150	200	400	--	5	3RW5248-□□C□4	1	1 unit	42S

Type of electrical connection for the control circuit

Spring-loaded terminals

Screw terminals

Product function

Analog output

Thermistor motor protection

Control supply voltage

24 V AC/DC

110 ... 250 V AC

¹⁾ 3RW52 soft starter with screw terminals for operational voltage up to 480 V:
Standard delivery time SD = 1 day (d).

Note:

For the constraints for the motor outputs specified here, see page 6/8.



Switching devices – Soft starters and solid-state switching devices

SIRIUS 3RW soft starters

General Performance soft starters

IE3/IE4 ready 3RW52 soft starters > Inline circuit

For normal starting (CLASS 10A)

3RW521.1



3RW522.1



3RW523.1



3RW524.1

At 40 °C				At 50 °C				SD ¹⁾	Article No.	Price per PU	PU (UNIT, SET, M)	PS*	PG
Operational current	Operating power for three-phase motors			Operational current	Rating [hp] for three-phase motors								
	At 230 V	At 400 V	At 500 V		At 200/208 V	At 220/230 V	At 460/480 V	At 575/600 V	d				
A	kW	kW	kW	A	hp	hp	hp	hp					
Operational voltage 200 ... 600 V													
13	3	5.5	7.5	11.5	2	3	7.5	10	5	3RW5213-□□C□5	1	1 unit	42S
18	4	7.5	11	15.9	3	5	10	10	5	3RW5214-□□C□5	1	1 unit	42S
25	5.5	11	15	22.3	5	7.5	15	20	5	3RW5215-□□C□5	1	1 unit	42S
32	7.5	15	18.5	28.4	7.5	10	20	25	5	3RW5216-□□C□5	1	1 unit	42S
38	11	18.5	22	33.5	10	10	20	30	5	3RW5217-□□C□5	1	1 unit	42S
47	11	22	30	41.6	10	10	30	40	5	3RW5224-□□C□5	1	1 unit	42S
63	18.5	30	37	55.5	15	20	40	50	5	3RW5225-□□C□5	1	1 unit	42S
77	22	37	45	68	20	25	50	60	5	3RW5226-□□C□5	1	1 unit	42S
93	22	45	55	82.5	25	30	60	75	5	3RW5227-□□C□5	1	1 unit	42S

Type of electrical connection for the control circuit

Screw terminals

Spring-loaded terminals

Product function

Analog output

Thermistor motor protection

Control supply voltage

24 V AC/DC

110 ... 250 V AC

- ¹⁾ 3RW52 soft starter with screw terminals for operational voltage up to 600 V:
Standard delivery time SD = 2 days (d).

Note:

For the constraints for the motor outputs specified here, see page 6/8.

1
3
A
T
0
1

At 40 °C				At 50 °C				SD ¹⁾	Article No.	Price per PU	PU (UNIT, SET, M)	PS*	PG
Operational current	Operating power for three-phase motors			Operational current	Rating [hp] for three-phase motors								
	At 230 V	At 400 V	At 500 V		At 200/208 V	At 220/230 V	At 460/480 V	At 575/600 V	d				
A	kW	kW	kW	A	hp	hp	hp	hp					
Operational voltage 200 ... 600 V													
113	30	55	75	101	30	30	75	100	5	3RW5234-□□C□5	1	1 unit	42S
143	37	75	90	128	40	40	100	125	5	3RW5235-□□C□5	1	1 unit	42S
171	45	90	110	153	50	50	100	150	5	3RW5236-□□C□5	1	1 unit	42S
210	55	110	132	186	60	60	150	150	5	3RW5243-□□C□5	1	1 unit	42S
250	75	132	160	220	60	75	150	200	5	3RW5244-□□C□5	1	1 unit	42S
315	90	160	200	279	75	100	200	250	5	3RW5245-□□C□5	1	1 unit	42S
370	110	200	250	328	100	125	250	300	5	3RW5246-□□C□5	1	1 unit	42S
470	132	250	315	416	150	150	350	450	5	3RW5247-□□C□5	1	1 unit	42S
570	160	315	355	504	150	200	400	500	5	3RW5248-□□C□5	1	1 unit	42S

Type of electrical connection for the control circuit

Spring-loaded terminals

Screw terminals

Product function

Analog output

Thermistor motor protection

Control supply voltage

24 V AC/DC

110 ... 250 V AC

- ¹⁾ 3RW52 soft starter with screw terminals for operational voltage up to 600 V:
Standard delivery time SD = 2 days (d).

Note:

For the constraints for the motor outputs specified here, see page 6/8.

2
6
A
T
0
1

Switching devices – Soft starters and solid-state switching devices

SIRIUS 3RW soft starters

General Performance soft starters

3RW52 soft starters > Inside-delta circuit **IE3/IE4 ready**

Selection and ordering data

For normal starting (CLASS 10A)



3RW521.1



3RW522.



3RW523.



3RW524.

At 40 °C for inside-delta circuit				At 50 °C for inside-delta circuit				SD ¹⁾	Article No.	Price per PU	PU (UNIT, SET, M)	PS*	PG
Operational current	Operating power for three-phase motors			Operational current	Rating [hp] for three-phase motors								
	At 230 V	At 400 V	At 500 V		At 200/208 V	At 220/230 V	At 460/480 V	At 575/600 V					
A	kW	kW	kW	A	hp	hp	hp	hp	d				
Operational voltage 200 ... 480 V													
22.5	5.5	11	--	19.9	5	5	10	--	5	3RW5213-□□C□4	1	1 unit	42S
31.5	7.5	15	--	28	7.5	7.5	20	--	5	3RW5214-□□C□4	1	1 unit	42S
43.3	11	18.5	--	39	10	10	25	--	5	3RW5215-□□C□4	1	1 unit	42S
55.4	15	22	--	49	15	15	30	--	5	3RW5216-□□C□4	1	1 unit	42S
65.8	18.5	30	--	58	15	20	40	--	5	3RW5217-□□C□4	1	1 unit	42S
81.4	22	45	--	72	20	25	50	--	5	3RW5224-□□C□4	1	1 unit	42S
109	30	55	--	96	30	30	75	--	5	3RW5225-□□C□4	1	1 unit	42S
133	37	75	--	118	30	40	75	--	5	3RW5226-□□C□4	1	1 unit	42S
161	45	90	--	143	40	50	100	--	5	3RW5227-□□C□4	1	1 unit	42S

Type of electrical connection for the control circuit

- Screw terminals
- Spring-loaded terminals

Product function

- Analog output
- Thermistor motor protection

Control supply voltage

- 24 V AC/DC
- 110 ... 250 V AC

¹⁾ 3RW52 soft starter with screw terminals for operational voltage up to 480 V: Standard delivery time SD = 1 day (d).

Note:

For the constraints for the motor outputs specified here, see page 6/8.



At 40 °C for inside-delta circuit				At 50 °C for inside-delta circuit				SD ¹⁾	Article No.	Price per PU	PU (UNIT, SET, M)	PS*	PG
Operational current	Operating power for three-phase motors			Operational current	Rating [hp] for three-phase motors								
	At 230 V	At 400 V	At 500 V		At 200/208 V	At 220/230 V	At 460/480 V	At 575/600 V					
A	kW	kW	kW	A	hp	hp	hp	hp	d				
Operational voltage 200 ... 480 V													
196	55	110	--	175	50	60	125	--	5	3RW5234-□□C□4	1	1 unit	42S
248	75	132	--	222	75	75	150	--	5	3RW5235-□□C□4	1	1 unit	42S
296	90	160	--	265	75	100	200	--	5	3RW5236-□□C□4	1	1 unit	42S
364	110	200	--	322	100	125	250	--	5	3RW5243-□□C□4	1	1 unit	42S
433	132	250	--	381	125	150	300	--	5	3RW5244-□□C□4	1	1 unit	42S
546	160	315	--	483	150	200	400	--	5	3RW5245-□□C□4	1	1 unit	42S
641	200	355	--	568	200	200	450	--	5	3RW5246-□□C□4	1	1 unit	42S
814	250	400	--	721	250	250	600	--	5	3RW5247-□□C□4	1	1 unit	42S
987	315	560	--	873	300	350	750	--	5	3RW5248-□□C□4	1	1 unit	42S

Type of electrical connection for the control circuit

- Spring-loaded terminals
- Screw terminals

Product function

- Analog output
- Thermistor motor protection

Control supply voltage

- 24 V AC/DC
- 110 ... 250 V AC

¹⁾ 3RW52 soft starter with screw terminals for operational voltage up to 480 V: Standard delivery time SD = 1 day (d).

Note:

For the constraints for the motor outputs specified here, see page 6/8.



Switching devices – Soft starters and solid-state switching devices

SIRIUS 3RW soft starters

General Performance soft starters

IE3/IE4 ready 3RW52 soft starters > Inside-delta circuit

For normal starting (CLASS 10A)



3RW521.1



3RW522.1



3RW523.1



3RW524.1

At 40 °C for inside-delta circuit				At 50 °C for inside-delta circuit				SD ¹⁾	Article No.	Price per PU	PU (UNIT, SET, M)	PS*	PG
Operational current	Operating power for three-phase motors			Operational current	Rating [hp] for three-phase motors								
	At 230 V	At 400 V	At 500 V		At 200/208 V	At 220/230 V	At 460/480 V	At 575/600 V	d				
A	kW	kW	kW	A	hp	hp	hp	hp					
Operational voltage 200 ... 600 V													
22.5	5.5	11	15	19.9	5	5	10	15	5	3RW5213-□□C□5	1	1 unit	42S
31.5	7.5	15	18.5	28	7.5	7.5	20	25	5	3RW5214-□□C□5	1	1 unit	42S
43.3	11	18.5	22	39	10	10	25	30	5	3RW5215-□□C□5	1	1 unit	42S
55.4	15	22	30	49	15	15	30	40	5	3RW5216-□□C□5	1	1 unit	42S
65.8	18.5	30	37	58	15	20	40	50	5	3RW5217-□□C□5	1	1 unit	42S
81.4	22	45	45	72	20	25	50	60	5	3RW5224-□□C□5	1	1 unit	42S
109	30	55	55	96	30	30	75	75	5	3RW5225-□□C□5	1	1 unit	42S
133	37	75	90	118	30	40	75	100	5	3RW5226-□□C□5	1	1 unit	42S
161	45	90	110	143	40	50	100	125	5	3RW5227-□□C□5	1	1 unit	42S

Type of electrical connection for the control circuit

- Screw terminals
- Spring-loaded terminals

Product function

- Analog output
- Thermistor motor protection

Control supply voltage

- 24 V AC/DC
- 110 ... 250 V AC

¹⁾ 3RW52 soft starter with screw terminals for operational voltage up to 600 V: Standard delivery time SD = 2 days (d).

Note:

For the constraints for the motor outputs specified here, see page 6/8.



At 40 °C for inside-delta circuit				At 50 °C for inside-delta circuit				SD ¹⁾	Article No.	Price per PU	PU (UNIT, SET, M)	PS*	PG
Operational current	Operating power for three-phase motors			Operational current	Rating [hp] for three-phase motors								
	At 230 V	At 400 V	At 500 V		At 200/208 V	At 220/230 V	At 460/480 V	At 575/600 V	d				
A	kW	kW	kW	A	hp	hp	hp	hp					
Operational voltage 200 ... 600 V													
196	55	110	132	175	50	60	125	150	5	3RW5234-□□C□5	1	1 unit	42S
248	75	132	160	222	75	75	150	200	5	3RW5235-□□C□5	1	1 unit	42S
296	90	160	200	265	75	100	200	250	5	3RW5236-□□C□5	1	1 unit	42S
364	110	200	250	322	100	125	250	300	5	3RW5243-□□C□5	1	1 unit	42S
433	132	250	315	381	125	150	300	350	5	3RW5244-□□C□5	1	1 unit	42S
546	160	315	355	483	150	200	400	500	5	3RW5245-□□C□5	1	1 unit	42S
641	200	355	450	568	200	200	450	600	5	3RW5246-□□C□5	1	1 unit	42S
814	250	400	500	721	250	250	600	800	5	3RW5247-□□C□5	1	1 unit	42S
987	315	560	630	873	300	350	750	950	5	3RW5248-□□C□5	1	1 unit	42S

Type of electrical connection for the control circuit

- Spring-loaded terminals
- Screw terminals

Product function

- Analog output
- Thermistor motor protection

Control supply voltage

- 24 V AC/DC
- 110 ... 250 V AC

¹⁾ 3RW52 soft starter with screw terminals for operational voltage up to 600 V: Standard delivery time SD = 2 days (d).

Note:

For the constraints for the motor outputs specified here, see page 6/8.



Switching devices – Soft starters and solid-state switching devices

SIRIUS 3RW soft starters

General Performance soft starters

3RW52 soft starters > Accessories

Selection and ordering data







Product designation	Manufacturer's Article No. of the soft starter	Type of product	Application	SD	Article No.	Price per PU	PU (UNIT, SET, M)	PS*	PG	
Fan covers										
	Fan cover	3RW5216/17 (1x), 3RW5226/27 (2x), 3RW523 (2x)	--	--	▶	3RW5983-0FC00		1	1 unit	42S
		3RW524 (1x)	--	--	▶	3RW5984-0FC00		1	1 unit	42S
3RW5983-0FC00										
Terminal covers										
	Terminal cover	3RW522 (2x), 3RW523 (2x)	--	--	▶	3RW5983-0TC20		1	1 unit	42S
		3RW524 (2x)	--	--	▶	3RW5984-0TC20		1	1 unit	42S
3RW5983-0TC20										
3RW5984-0TC20										
Enclosure components										
	Hinged cover	3RW52	With cutout for High Feature HMI module	--	▶	3RW5950-0GL30		1	1 unit	42S
			With cutout for Standard HMI module	--	▶	3RW5950-0GL40		1	1 unit	42S
3RW5950-0GL30										
3RW5950-0GL40										
Communication modules										
	Communication module	3RW52	PROFINET Standard	--	▶	3RW5980-0CS00		1	1 unit	42S
			PROFIBUS	--	▶	3RW5980-0CP00		1	1 unit	42S
			EtherNet/IP	--	▶	3RW5980-0CE00		1	1 unit	42S
3RW5980-0CS00										
			Modbus RTU	--	▶	3RW5980-0CR00		1	1 unit	42S
			Modbus TCP	--	▶	3RW5980-0CT00		1	1 unit	42S
3RW5980-0CR00										

Switching devices – Soft starters and solid-state switching devices

SIRIUS 3RW soft starters

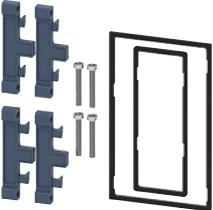
General Performance soft starters

3RW52 soft starters > Accessories

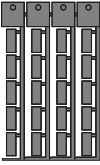
Product designation	Manufacturer's Article No. of the soft starter	Type of product	Application	SD	Article No.	Price per PU	PU (UNIT, SET, M)	PS*	PG
HMI modules									
	HMI module	3RW52	High Feature	--	▶ 3RW5980-0HF00		1	1 unit	42S
3RW5980-0HF00									
			Standard	--	▶ 3RW5980-0HS00		1	1 unit	42S
3RW5980-0HS00									
	IP65 door mounting kit for HMI modules	3RW52	IP65	For HMI modules	▶ 3RW5980-0HD00		1	1 unit	42S
3RW5980-0HD00									
Connecting cables									
	HMI connecting cable	3RW52	5 m, round	For door mounting	▶ 3RW5980-0HC60		1	1 unit	42S
			2.5 m, round		▶ 3UF7933-0BA00-0		1	1 unit	42J
			1.0 m, round		▶ 3UF7937-0BA00-0		1	1 unit	42J
			0.5 m, round		▶ 3UF7932-0BA00-0		1	1 unit	42J
3UF793.-0BA00-0									
			0.1 m, flat	For mounting in the device	▶ 3UF7931-0AA00-0		1	1 unit	42J
3UF7931-0AA00-0									
Further accessories									
	Push-in lugs for wall mounting	--	Two lugs are required per device	For HMI modules and communication modules	2 ▶ 3ZY1311-0AA00		1	10 units	41L
3ZY1311-0AA00									
Blank labels									
	Unit labeling plates¹⁾	--	20 mm x 7 mm, titanium gray	For SIRIUS devices	20 ▶ 3RT2900-1SB20		100	340 units	41B
3RT2900-1SB20									

¹⁾ PC labeling systems for individual inscription of unit labeling plates are available from: murrplastik Systemtechnik GmbH (see page 16/16).

Switching devices – Soft starters and solid-state switching devices

SIRIUS 3RW soft starters

Basic Performance soft starters

3RW50 soft starters > General data

Overview

More information

Homepage, see www.siemens.com/sirius-soft-starter
 Industry Mall, see www.siemens.com/product?3RW50
 TIA Selection Tool Cloud (TST Cloud), see <https://www.siemens.com/tstcloud/?node=3rw50>
 Industry Online Support (SOS) topic page, see <https://support.industry.siemens.com/cs/ww/en/view/109747404>

Simulation Tool for Soft Starters (STS), see page 6/9 or <https://support.industry.siemens.com/cs/ww/en/view/101494917>
 SIRIUS Soft Starter ES (TIA Portal) for diagnostics, see page 6/9 or <https://support.industry.siemens.com/cs/ww/en/ps/24230/dl>



SIRIUS 3RW50 soft starters device family

SIRIUS 3RW50 Basic Performance soft starters are the compact solution for standard applications. With 2-phase motor control, they cover the performance range from 75 to 315 kW (at 400 V).

Optional HMI modules for installation in the control cabinet door, laterally mountable communication modules (PROFINET, PROFIBUS, EtherNet/IP and Modbus) and either an analog output or thermistor motor protection ensure maximum flexibility.

With their modern hybrid switching technology, the SIRIUS 3RW50 soft starters offer efficient switching for long-term, energy-saving use.

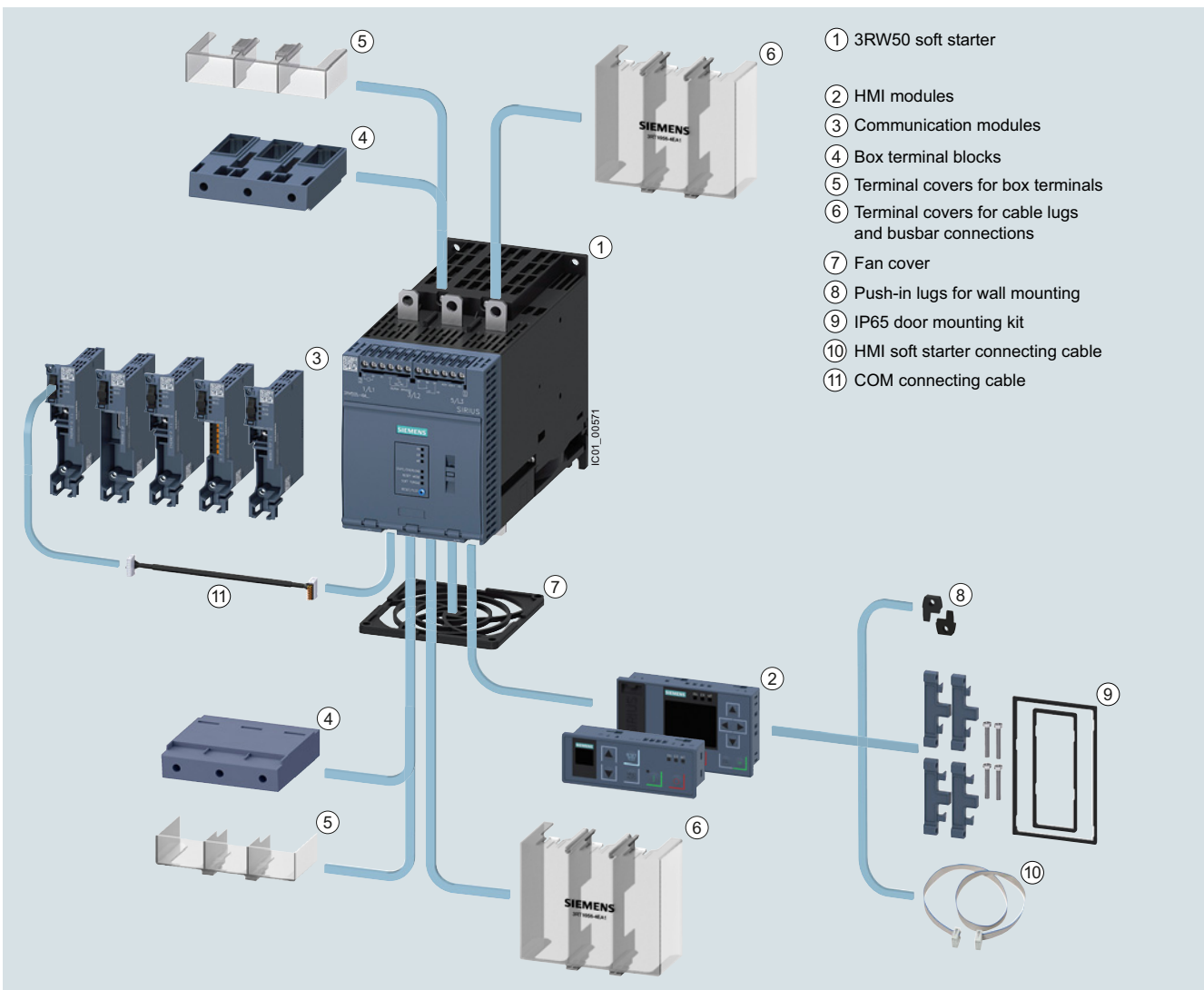

- ① 3RW50 soft starter
- ② HMI modules
- ③ Communication modules
- ④ Box terminal blocks
- ⑤ Terminal covers for box terminals
- ⑥ Terminal covers for cable lugs and busbar connections
- ⑦ Fan cover
- ⑧ Push-in lugs for wall mounting
- ⑨ IP65 door mounting kit
- ⑩ HMI soft starter connecting cable
- ⑪ COM connecting cable

SIRIUS 3RW50 Basic Performance soft starter with accessories (see page 6/81), for expansion with HMI module or communication module

Switching devices – Soft starters and solid-state switching devices

SIRIUS 3RW soft starters
Basic Performance soft starters

3RW50 soft starters > General data

Benefits

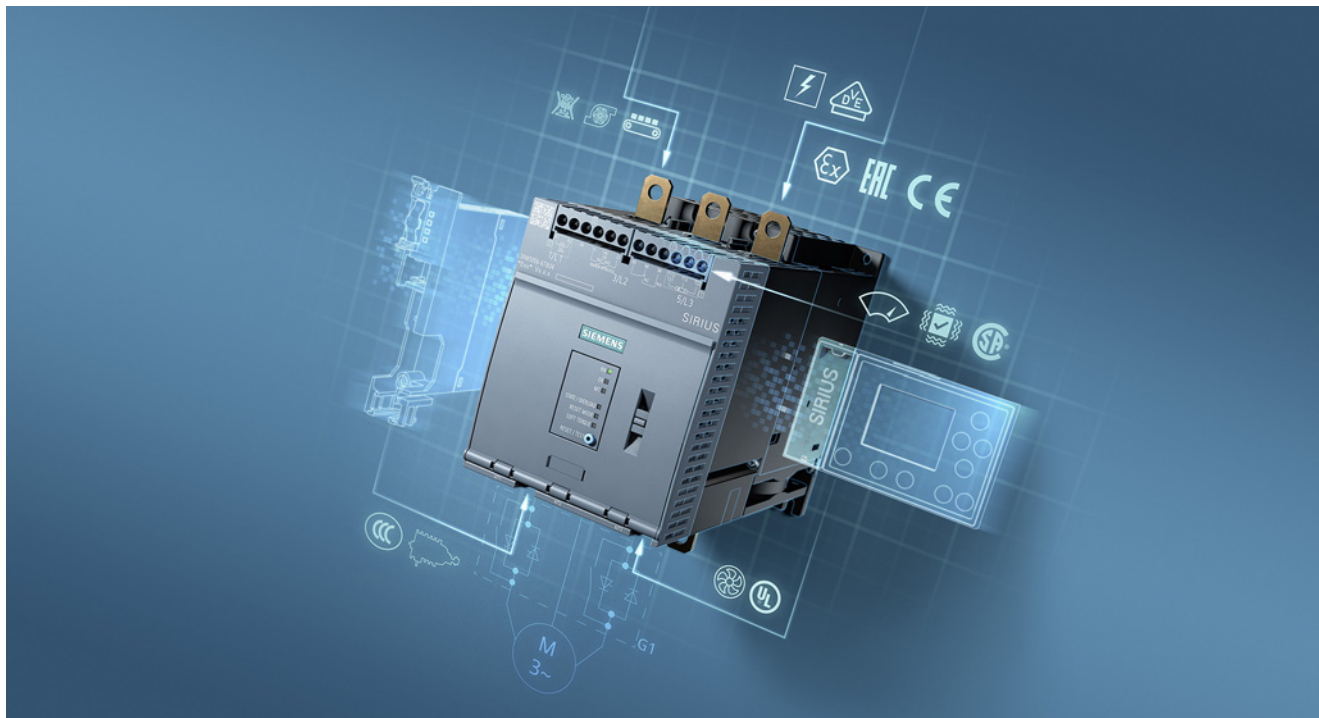

Product characteristics / function	Performance features / benefits
Hybrid switching technology and 2-phase motor control	Minimum power loss and optimized motor control by avoiding DC components
Small and compact design	Space-saving, clearly arranged control panel layout
TIA integration – communication modules and HMI modules optional	Efficient configuration and maximum flexibility in automation engineering
Motor overload and intrinsic device protection without additional wiring	Adjustable trip classes, integrated diagnostic functions
Soft Torque	Reduced mechanical loading and optimum pump stop
Parameterization using potentiometers	Simple and fast commissioning
Wide range for control supply and main voltage	Low variance, high system availability even with weak supply networks
Certified according to ATEX/IECEx directive	Suitable for the starting of explosion-proof motors with "increased safety" type of protection

Switching devices – Soft starters and solid-state switching devices

SIRIUS 3RW soft starters

Basic Performance soft starters

3RW50 soft starters > General data

Technical specifications

More information

Technical specifications, see
<https://support.industry.siemens.com/cs/ww/en/ps/25252/td>
 Equipment Manual, see
<https://support.industry.siemens.com/cs/ww/en/view/109753750>

FAQs, see <https://support.industry.siemens.com/cs/ww/en/ps/25252/faq>
 Simulation Tool for Soft Starters (STS), see page 6/9 or
<https://support.industry.siemens.com/cs/ww/en/view/101494917>

Type

3RW5055
3RW5056

3RW5072
3RW5073
3RW5074
3RW5075
3RW5076
3RW5077

Installation/fixing/dimensions

Width x height x depth

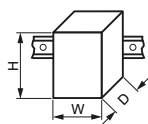

mm 120 × 198 × 249

160 × 230 × 282

Type of mounting

Screw fixing

Mounting position

For vertical mounting surface can be rotated +/- 90°,
 for vertical mounting surface can be tilted +/- 22.5° forward or backward

Distance to be maintained with side-by-side mounting

- Above mm 100
- At the side mm 5
- Below mm 75

Maximum installation altitude above sea level¹⁾

m 5 000

Degree of protection IP on the front acc. to IEC 60529

IP00 (IP20 with cover)

Touch protection on the front acc. to IEC 60529

Finger-safe for vertical touching from the front with cover

Ambient conditions

Ambient temperature

- During operation²⁾ °C -25 ... +60
- During storage and transport °C -40 ... +80

Environmental category according to IEC 60721

- During operation 3K6 (no ice formation, only occasional condensation), 3C3 (no salt mist), 3S2 (sand must not get into the devices), 3M6
- During storage 1K6 (only occasional condensation), 1C2 (no salt mist), 1S2 (sand must not get into the devices), 1M4
- During transport 2K2, 2C1, 2S1, 2M2 (max. height of fall 0.3 m)

¹⁾ Derating from 1 000 m, see characteristic curve on page 6/8.

²⁾ Note derating above 40 °C.

Type

3RW50...B0.

3RW50...B1.

Control circuit/control

Control supply voltage

- | | V | 3RW50...B0. | 3RW50...B1. |
|---|---|-------------|-------------|
| • At AC/DC, rated value | V | 24/24 | --/-- |
| • At AC | V | -- | 110 ... 250 |
| • Relative negative tolerance/relative positive tolerance with AC | % | -20/20 | -15/10 |
| • Relative negative tolerance/relative positive tolerance with DC | % | -20/20 | --/-- |

Frequency of the control supply voltage

- | | Hz | 3RW50...B0. | 3RW50...B1. |
|---|----|-------------|-------------|
| • Relative negative tolerance/relative positive tolerance | % | 50 ... 60 | -10/10 |

Type of overvoltage protection

Varistors

Type of short-circuit protection for control circuit¹⁾

Fuse 4 A gG ($I_{cu} = 1$ kA), fuse 6 A quick-response ($I_{cu} = 1$ kA),
 MCB C1 ($I_{cu} = 600$ A), MCB C6 ($I_{cu} = 300$ A)

¹⁾ Not included in scope of supply

Type

3RW50...B4

3RW50...B5

Power electronics

Operational voltage, rated value

- | | V | 3RW50...B4 | 3RW50...B5 |
|---|---|-------------|-------------|
| Operational voltage, rated value | V | 200 ... 480 | 200 ... 600 |
| • Relative negative tolerance/relative positive tolerance | % | -15/10 | |

Operating frequency, rated value

- | | Hz | 3RW50...B4 | 3RW50...B5 |
|---|----|------------|------------|
| Operating frequency, rated value | Hz | 50 ... 60 | |
| • Relative negative tolerance/relative positive tolerance | % | -10/10 | |

Minimum load [% of I_M]¹⁾

% 15

Maximum cable length between soft starter and motor

m 800

¹⁾ Relative to the smallest adjustable I_e .

Switching devices – Soft starters and solid-state switching devices

SIRIUS 3RW soft starters

Basic Performance soft starters

3RW50 soft starters > General data

Type		3RW5055	3RW5056				
Rated operational current I_e	A	143	171				
Power electronics							
Load rating with rated operational current I_e							
IEC + UL/CSA, individual mounting at 40/50/60 °C, AC-53a	A	143/128/118	171/153/141				
Permissible rated motor current and starts/h							
Normal starting (CLASS 10A)							
Rated motor current I_M , $T_U = 40/50/60$ °C ON period = 70%; motor protection activated	A	143/128/118	171/153/141				
• 300% I_M							
- Start-up time 5 s	1/h	43	43				
- Start-up time 10 s	1/h	18	18				
• 350% I_M							
- Start-up time 5 s	1/h	28	28				
- Start-up time 10 s	1/h	10	9				
Normal starting (CLASS 10E)							
Rated motor current I_M , $T_U = 40/50/60$ °C ON period = 70%; motor protection activated	A	143/128/118	171/153/141				
• 300% I_M							
- Start-up time 10 s	1/h	21	21				
- Start-up time 20 s	1/h	8	8				
• 350% I_M							
- Start-up time 10 s	1/h	12	9				
- Start-up time 20 s	1/h	4	--				
Heavy starting (CLASS 20E)							
Rated motor current I_M , $T_U = 40/50/60$ °C ON period = 70%; motor protection activated	A	108/98/88	135/123/111				
• 300% I_M							
- Start-up time 20 s	1/h	10	10				
- Start-up time 40 s	1/h	4	4				
• 350% I_M							
- Start-up time 20 s	1/h	7	7				
- Start-up time 40 s	1/h	2.5	2.5				
Adjustable rated motor current I_M							
• Minimum/maximum	A	68/143	81/117				
Power electronics							
Load rating with rated operational current I_e							
IEC + UL/CSA, individual mounting at 40/50/60 °C, AC-53a	A	210/186/170	250/220/200	315/279/255	370/328/300	470/416/380	570/504/460
Permissible rated motor current and starts/h							
Normal starting (CLASS 10A)							
Rated motor current I_M , $T_U = 40/50/60$ °C ON period = 70%; motor protection activated	A	210/186/170	250/220/200	315/279/255	370/328/300	470/416/380	570/504/460
• 300% I_M							
- Start-up time 5 s	1/h	43	43	43	43	43	28
- Start-up time 10 s	1/h	18	18	18	18	18	11
• 350% I_M							
- Start-up time 5 s	1/h	28	28	28	28	28	16
- Start-up time 10 s	1/h	8	10	10	10	10	4
Normal starting (CLASS 10E)							
Rated motor current I_M , $T_U = 40/50/60$ °C ON period = 70%; motor protection activated	A	210/186/170	250/220/200	315/279/255	370/328/300	470/416/380	570/504/460
• 300% I_M							
- Start-up time 10 s	1/h	21	21	21	21	20	21
- Start-up time 20 s	1/h	8	8	8	8	7	8
• 350% I_M							
- Start-up time 10 s	1/h	8	13	12	13	12	13
- Start-up time 20 s	1/h	--	4	4	4	2	4
Heavy starting (CLASS 20E)							
Rated motor current I_M , $T_U = 40/50/60$ °C ON period = 70%; motor protection activated	A	162/146/130	200/180/160	219/195/171	258/230/202	272/254/218	284/262/240
• 300% I_M							
- Start-up time 20 s	1/h	10	10	10	10	10	10
- Start-up time 40 s	1/h	4	4	4	4	4	4
• 350% I_M							
- Start-up time 20 s	1/h	7	7	7	7	7	7
- Start-up time 40 s	1/h	2.5	2.5	2.5	2.5	2.5	2.5
Adjustable rated motor current I_M							
• Minimum/maximum	A	90/210	100/250	135/315	160/370	200/470	240/570

Switching devices – Soft starters and solid-state switching devices

SIRIUS 3RW soft starters

Basic Performance soft starters

3RW50 soft starters > General data

Motor feeders according to IEC with 3VA circuit breakers (without semiconductor protection)

Type of coordination "1", CLASS 10,
short-circuit breaking capacity I_q in kA, [see table](#)

Note:

For general recommendations for constructing motor feeders
with soft starters, [see page 6/11](#).

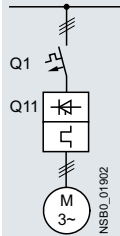

Soft starters	Motor starter protectors		Motor starter protectors	
	for 400 V systems		for 500 V systems	
Q11	Q1	I_q	Q1	I_q
Type	Type	kA	Type	kA
Type of coordination "1"	Inline circuit			
3RW5055	3VA2220-7MN32-0AA0	20	3VA2220-7MN32-0AA0	20
3RW5056	3VA2220-7MN32-0AA0	20	3VA2220-7MN32-0AA0	20
3RW5072	3VA2440-7MN32-0AA0	65	3VA2440-7MN32-0AA0	65
3RW5073	3VA2440-7MN32-0AA0	65	3VA2440-7MN32-0AA0	65
3RW5074	3VA2440-7MN32-0AA0	65	3VA2440-7MN32-0AA0	65
3RW5075	3VA2580-6HN32-0AA0	65	3VA2580-6HN32-0AA0	65
3RW5076	3VA2580-6HN32-0AA0	65	3VA2580-6HN32-0AA0	65
3RW5077	3VA2580-6HN32-0AA0	65	3VA2580-6HN32-0AA0	65

Note:

The service factor and measurement inaccuracies, for example, have been taken into account for the selection of the specified circuit breakers; the specified short-circuit breaking capacities I_q in kA are covered by combination tests. Smaller motor starter protectors/circuit breakers from the same series can be used at any time as smaller ones trip more quickly in the event of a short circuit (unchanged short-circuit breaking capacity) and thus protect the soft starter in any case. The dimensioning of the short-circuit components must match the connected three-phase motor, the short-circuit and overload requirements of the application, and the line protection for the cables used.

Switching devices – Soft starters and solid-state switching devices

SIRIUS 3RW soft starters
Basic Performance soft starters

3RW50 soft starters > General data

Motor feeders according to IEC with 3NA3 fuses

gG class full-range fuses for cable and line protection according to IEC 60269-2, without semiconductor protection

Type of coordination "1",
short-circuit breaking capacity $I_{q} = 65 \text{ kA}$

Note:

For general recommendations for constructing motor feeders with soft starters, [see page 6/11](#).

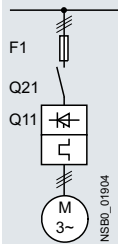

Soft starters	gG class fuse	Line contactor (optional)	
	for systems up to 600 V	for systems up to 480 V	for systems up to 600 V
Q11	F1	Q21	Q21
Type	Type	Type	Type
Type of coordination "1"	Inline circuit		
3RW5055	3NA3244-6	3RT1055	3RT1055
3RW5056	3NA3244-6	3RT1056	3RT1064
3RW5072	2 x 3NA3354-6	3RT1064	3RT1064
3RW5073	2 x 3NA3354-6	3RT1065	3RT1065
3RW5074	2 x 3NA3365-6	3RT1075	3RT1075
3RW5075	2 x 3NA3365-6	3RT1075	3RT1075
3RW5076	2 x 3NA3365-6	3RT1076	3RT1076
3RW5077	2 x 3NA3365-6	3TF68	3TF68

Note:

The specified short-circuit breaking capacities I_{q} in kA are covered by combination tests. Smaller fuses than those specified can be used at any time as smaller ones trip more quickly in the event of a short circuit (unchanged short-circuit breaking capacity) and thus protect the soft starter in any case. The dimensioning of the short-circuit components must, however, be suitable for the connected three-phase motor and the line protection for the cables used.

Switching devices – Soft starters and solid-state switching devices

SIRIUS 3RW soft starters

Basic Performance soft starters

3RW50 soft starters > General data

Motor feeders according to IEC with 3NE1 SITOR fuses

gR class full-range fuses for semiconductor protection, cable and line protection

Type of coordination "2",
short-circuit breaking capacity $I_{cs} = 65 \text{ kA}$

Note:

For general recommendations for constructing motor feeders with soft starters, [see page 6/11](#).

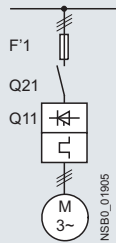

Soft starters	gR class fuse	Line contactor (optional)	
	for systems up to 600 V	for systems up to 480 V	for systems up to 600 V
Q11	F'1	Q21	Q21
Type	Type	Type	Type
Type of coordination "2"	Inline circuit Toc 2		
3RW5055	3NE1227-0	3RT1055	3RT1055
3RW5056	3NE1230-0	3RT1056	3RT1064
3RW5072	3NE1230-2	3RT1064	3RT1064
3RW5073	3NE1331-0	3RT1065	3RT1065
3RW5074	3NE1333-2	3RT1075	3RT1075
3RW5075	3NE1334-2	3RT1075	3RT1075
3RW5076	3NE1436-2	3RT1076	3RT1076
3RW5077	3NE1437-2	3TF68	3TF68

Note:

The specified short-circuit breaking capacities I_{cs} in kA are covered by combination tests. Smaller fuses than those specified can be used at any time as smaller ones trip more quickly in the event of a short circuit (unchanged short-circuit breaking capacity) and thus protect the soft starter in any case. The dimensioning of the short-circuit components must, however, be suitable for the connected three-phase motor and the line protection for the cables used.

Motor feeders according to IEC with 3NE3 fuses

aR class partial-range fuses for semiconductor protection

Type of coordination "2",
short-circuit breaking capacity $I_q = 65$ kA

Note:

For general recommendations for constructing motor feeders with soft starters, [see page 6/11](#).

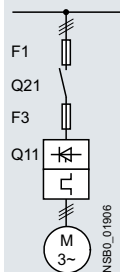

Soft starters	gG class fuse	aR class fuse	Line contactor (optional)	
	for systems up to 600 V	for systems up to 600 V	for systems up to 480 V	for systems up to 600 V
Q11	F1	F3	Q21	Q21
Type	Type	Type	Type	Type
Type of coordination "2"	Inline circuit			
3RW5055	3NA3244-6	3NE3334-0B	3RT1055	3RT1055
3RW5056	3NA3244-6	3NE3335	3RT1056	3RT1064
3RW5072	2 x 3NA3354-6	3NE3333	3RT1064	3RT1064
3RW5073	2 x 3NA3354-6	3NE3335	3RT1065	3RT1065
3RW5074	2 x 3NA3365-6	3NE3335	3RT1075	3RT1075
3RW5075	2 x 3NA3365-6	3NE3336	3RT1075	3RT1075
3RW5076	2 x 3NA3365-6	3NE3340-8	3RT1076	3RT1076
3RW5077	2 x 3NA3365-6	3NE3340-8	3TF68	3TF68

Note:

The specified short-circuit breaking capacities I_q in kA are covered by combination tests. Smaller fuses than those specified can be used at any time as smaller ones trip more quickly in the event of a short circuit (unchanged short-circuit breaking capacity) and thus protect the soft starter in any case. The dimensioning of the short-circuit components must, however, be suitable for the connected three-phase motor and the line protection for the cables used.

For CLASS 10 applications, as an alternative to the gG class full-range fuses for cable and line protection 3NA3 (F1), 3VA circuit breakers can also be used, possibly with reduced short-circuit breaking capacity ([see page 6/76](#)). In these cases, optional line contactors can be dispensed with.

Switching devices – Soft starters and solid-state switching devices

SIRIUS 3RW soft starters

Basic Performance soft starters

3RW50 soft starters > Inline circuit **IE3/IE4 ready**

Selection and ordering data

For normal starting (CLASS 10E)



3RW5055



3RW5075

At 40 °C		At 50 °C				Size	SD ¹⁾	Article No.	Price per PU	PU (UNIT, SET, M)	PS*	PG		
Operational current	Operating power for three-phase motors			Operational current	Rating [hp] for three-phase motors				d					
	At 230 V	At 400 V	At 500 V		At 200/208 V	At 220/230 V	At 460/480 V	At 575/600 V						
A	kW	kW	kW	A	hp	hp	hp	hp						
Operational voltage 200 ... 480 V														
143	37	75	--	128	40	40	100	--	S6	5	3RW5055-□□B□4	1	1 unit	42S
171	45	90	--	153	50	50	100	--	S6	5	3RW5056-□□B□4	1	1 unit	42S
210	55	110	--	186	60	60	150	--	S12	5	3RW5072-□□B□4	1	1 unit	42S
250	75	132	--	220	60	75	150	--	S12	5	3RW5073-□□B□4	1	1 unit	42S
315	90	160	--	279	75	100	200	--	S12	5	3RW5074-□□B□4	1	1 unit	42S
370	110	200	--	328	100	125	250	--	S12	5	3RW5075-□□B□4	1	1 unit	42S
470	132	250	--	416	150	150	350	--	S12	5	3RW5076-□□B□4	1	1 unit	42S
570	160	315	--	504	150	200	400	--	S12	5	3RW5077-□□B□4	1	1 unit	42S

Type of electrical connection for the control circuit

Spring-loaded terminals
Screw terminals

Product function

Analog output
Thermistor motor protection

Control supply voltage

24 V AC/DC
110 ... 250 V AC

¹⁾ 3RW50 soft starter with screw terminals for operational voltage up to 480 V: Standard delivery time SD = 1 day (d).

Note:

For the constraints for the motor outputs specified here, see page 6/8.



At 40 °C		At 50 °C				Size	SD ¹⁾	Article No.	Price per PU	PU (UNIT, SET, M)	PS*	PG		
Operational current	Operating power for three-phase motors			Operational current	Rating [hp] for three-phase motors				d					
	At 230 V	At 400 V	At 500 V		At 200/208 V	At 220/230 V	At 460/480 V	At 575/600 V						
A	kW	kW	kW	A	hp	hp	hp	hp						
Operational voltage 200 ... 600 V														
143	37	75	90	128	40	40	100	125	S6	5	3RW5055-□□B□5	1	1 unit	42S
171	45	90	110	153	50	50	100	150	S6	5	3RW5056-□□B□5	1	1 unit	42S
210	55	110	132	186	60	60	150	150	S12	5	3RW5072-□□B□5	1	1 unit	42S
250	75	132	160	220	60	75	150	200	S12	5	3RW5073-□□B□5	1	1 unit	42S
315	90	160	200	279	75	100	200	250	S12	5	3RW5074-□□B□5	1	1 unit	42S
370	110	200	250	328	100	125	250	300	S12	5	3RW5075-□□B□5	1	1 unit	42S
470	132	250	315	416	150	150	350	450	S12	2	3RW5076-□□B□5	1	1 unit	42S
570	160	315	355	504	150	200	400	500	S12	5	3RW5077-□□B□5	1	1 unit	42S

Type of electrical connection for the control circuit

Spring-loaded terminals
Screw terminals

Product function

Analog output
Thermistor motor protection

Control supply voltage

24 V AC/DC
110 ... 250 V AC

¹⁾ 3RW50 soft starter with screw terminals for operational voltage up to 600 V: Standard delivery time SD = 2 days (d).

Note:

For the constraints for the motor outputs specified here, see page 6/8.







Switching devices – Soft starters and solid-state switching devices

SIRIUS 3RW soft starters

Basic Performance soft starters

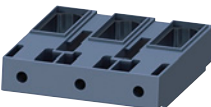
3RW50 soft starters > Accessories

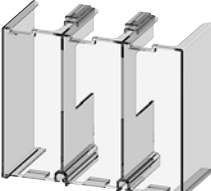
Selection and ordering data





Product designation	Manufacturer's Article No. of the soft starter	Type of product	Application	SD	Article No.	Price per PU	PU (UNIT, SET, M)	PS*	PG	
Fan covers										
	Fan cover	3RW50 (1x)	--	--	▶	3RW5985-0FC00		1	1 unit	42S
3RW5985-0FC00										
Box terminal block										
	Box terminal block for round and ribbon cables	3RW505 (2x)	Up to 70 mm ²	--	▶	3RT1955-4G		1	1 unit	41B
			Up to 120 mm ²	--	▶	3RT1956-4G		1	1 unit	41B
		3RW507 (2x)	Up to 240 mm ² (with auxiliary conductor connection)	--	▶	3RT1966-4G		1	1 unit	41B
3RT1956-4G										
Terminal covers										
	Covers for box terminals	3RW505 (2x)	--	--	▶	3RT1956-4EA2		1	1 unit	41B
			3RW507 (2x)	--	--	5	3RT1966-4EA2		1	1 unit
3RT1956-4EA2										
	Covers for cable lugs and busbar connections	3RW505 (2x)	--	--	▶	3RT1956-4EA1		1	1 unit	41B
			3RW507 (2x)	--	--	5	3RT1966-4EA1		1	1 unit
3RT1956-4EA1										
Communication modules										
	Communication module	3RW50	PROFINET Standard	--	▶	3RW5980-0CS00		1	1 unit	42S
			PROFIBUS	--	▶	3RW5980-0CP00		1	1 unit	42S
			EtherNet/IP	--	▶	3RW5980-0CE00		1	1 unit	42S
			Modbus RTU	--	▶	3RW5980-0CR00		1	1 unit	42S
			Modbus TCP	--	▶	3RW5980-0CT00		1	1 unit	42S
3RW5980-0CS00										
	COM connecting cable	3RW50	0.3 m, round	--	▶	3RW5900-0CC00		1	1 unit	42S
3RW5900-0CC00										
For mounting laterally on the device										

Switching devices – Soft starters and solid-state switching devices

SIRIUS 3RW soft starters

Basic Performance soft starters

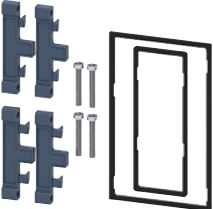
3RW50 soft starters > Accessories

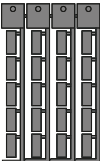
Product designation	Manufacturer's Article No. of the soft starter	Type of product	Application	SD	Article No.	Price per PU	PU (UNIT, SET, M)	PS*	PG
HMI modules									
	HMI module	3RW50	High Feature	--	▶ 3RW5980-0HF00		1	1 unit	42S
3RW5980-0HF00									
			Standard	--	▶ 3RW5980-0HS00		1	1 unit	42S
3RW5980-0HS00									
	IP65 door mounting kit for HMI modules	3RW50	IP65	For HMI modules	▶ 3RW5980-0HD00		1	1 unit	42S
3RW5980-0HD00									
Connecting cables									
	HMI connecting cable	3RW50	5 m, round	For door mounting	▶ 3RW5980-0HC60		1	1 unit	42S
			2.5 m, round		▶ 3UF7933-0BA00-0		1	1 unit	42J
			1.0 m, round		▶ 3UF7937-0BA00-0		1	1 unit	42J
			0.5 m, round		▶ 3UF7932-0BA00-0		1	1 unit	42J
3UF793.-0BA00-0									
Further accessories									
	Push-in lugs for wall mounting	--	Two lugs are required per device	For HMI modules and communication modules	2 3ZY1311-0AA00		1	10 units	41L
3ZY1311-0AA00									
Blank labels									
	Unit labeling plates¹⁾	--	20 mm x 7 mm, titanium gray	For SIRIUS devices	20 3RT2900-1SB20		100	340 units	41B
3RT2900-1SB20									

¹⁾ PC labeling systems for individual inscription of unit labeling plates are available from: murrplastik Systemtechnik GmbH (see page 16/16).

Switching devices – Soft starters and solid-state switching devices

SIRIUS 3RW soft starters
Basic Performance soft starters

3RW40 soft starters > General data

Overview

More information

Homepage, see www.siemens.com/sirius-soft-starter
Industry Mall, see www.siemens.com/product?3RW40

TIA Selection Tool Cloud (TST Cloud), see <https://www.siemens.com/tstcloud/?node=3rw40>
Simulation Tool for Soft Starters (STS), see page 6/9 or <https://support.industry.siemens.com/cs/ww/en/view/101494917>



SIRIUS 3RW40 soft starter

The SIRIUS 3RW40 Basic Performance soft starters are suitable for soft starting and stopping of three-phase asynchronous motors.

Thanks to 2-phase control, not only is the current kept at minimum values in all three phases throughout the entire starting time, but disturbing direct current components are also eliminated. This not only enables the 2-phase starting of motors up to 55 kW (at 400 V) but also avoids the current and torque peaks which occur e.g. with wye-delta starters.

The SIRIUS 3RW40 soft starters are suitable for the starting of explosion-proof motors with "increased safety" type of protection EEx e according to ATEX Directive 94/9/EC.

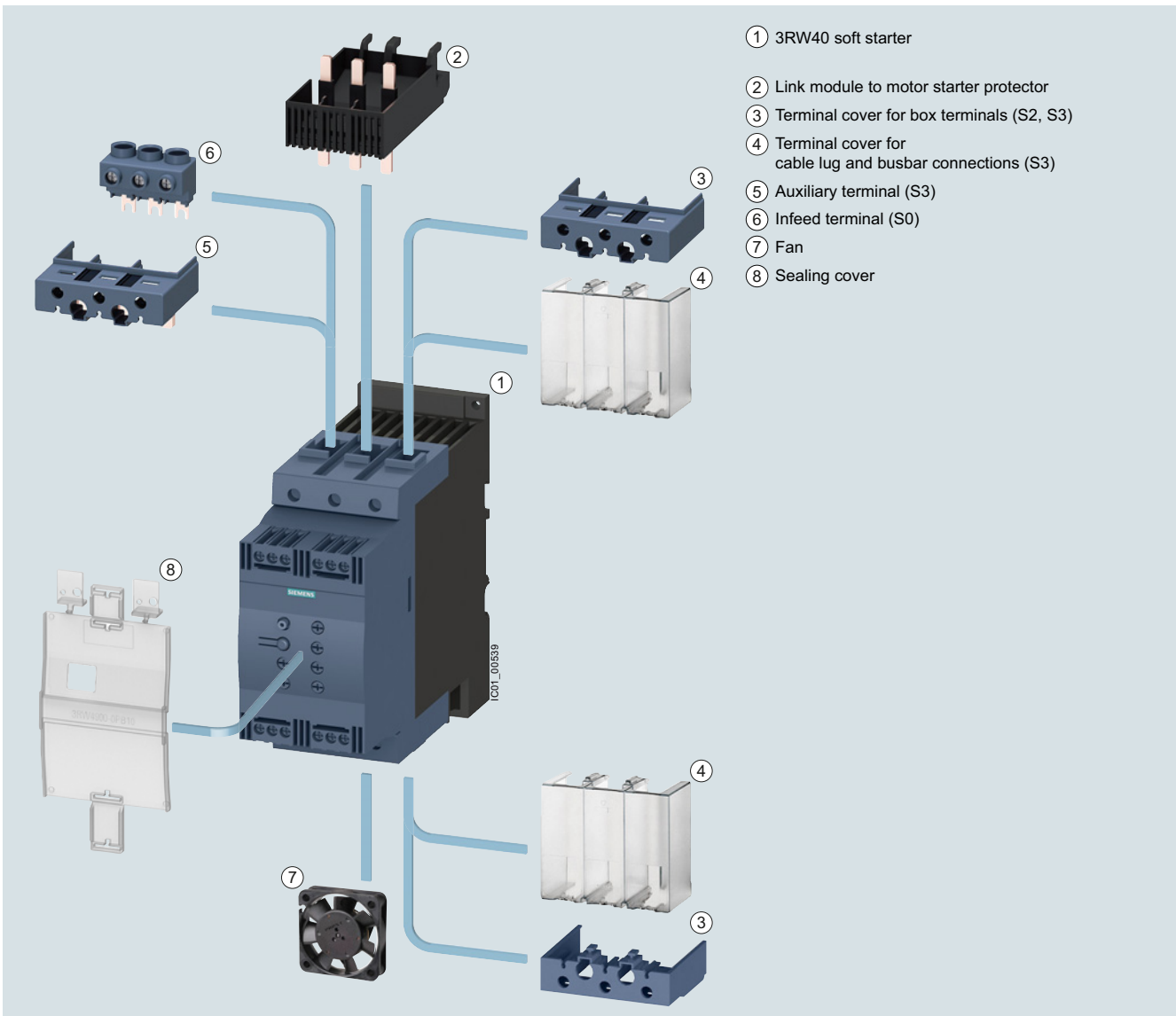

- ① 3RW40 soft starter
- ② Link module to motor starter protector
- ③ Terminal cover for box terminals (S2, S3)
- ④ Terminal cover for cable lug and busbar connections (S3)
- ⑤ Auxiliary terminal (S3)
- ⑥ Infeed terminal (S0)
- ⑦ Fan
- ⑧ Sealing cover

SIRIUS 3RW40 Basic Performance soft starter with accessories (see page 6/93)

Switching devices – Soft starters and solid-state switching devices

SIRIUS 3RW soft starters

Basic Performance soft starters

3RW40 soft starters > General data

Benefits



3RW402.



3RW403.



3RW404.

Product characteristics / function	Performance features / benefits
Small and compact design	Space-saving, clearly arranged control panel layout
Motor overload and intrinsic device protection without additional wiring	Adjustable trip classes, integrated diagnostic functions
Integrated in the SIRIUS modular system	Link modules to motor starter protectors
Hybrid switching technology and 2-phase motor control	Minimum power loss and optimized motor control by avoiding DC components
Certified according to ATEX Directive 94/9/EC	Suitable for the starting of explosion-proof motors with "increased safety" type of protection EEx e.
Optional thermistor motor protection	Full motor protection

Switching devices – Soft starters and solid-state switching devices

SIRIUS 3RW soft starters

Basic Performance soft starters



3RW40 soft starters > General data

Technical specifications

More information

Technical specifications, see <https://support.industry.siemens.com/cs/ww/en/ps/25251/td>
Equipment Manual, see <https://support.industry.siemens.com/cs/ww/en/view/38752095>

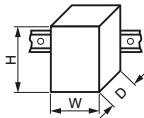
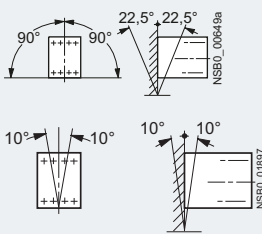
FAQs, see <https://support.industry.siemens.com/cs/ww/en/ps/25251/faq>
Simulation Tool for Soft Starters (STS), see page 6/9 or <https://support.industry.siemens.com/cs/ww/en/view/101494917>

Type		3RW402.	3RW403.	3RW404.
Mechanics and environment				
Mounting dimensions (W x H x D)		mm		
<ul style="list-style-type: none"> Screw terminals Spring-loaded terminals 		mm	45 x 125 x 154 45 x 150 x 154	55 x 144 x 170 55 x 144 x 170
Permissible ambient temperature		°C	-25 ... +60; (derating from +40)	
During operation		°C	-40 ... +80	
Weight		kg	0.77	1.35 1.9
Permissible mounting position¹⁾				
<ul style="list-style-type: none"> With auxiliary fan (for 3RW402. ... 3RW404.) Without auxiliary fan (for 3RW402. ... 3RW404.) 				
Installation type¹⁾	Stand-alone installation			
Permissible installation altitude		m	5 000 (Derating from 1 000, see characteristic curve on page 6/8)	
Degree of protection IP on the front acc. to IEC 60529			IP20	
Touch protection on the front acc. to IEC 60529			Finger-safe for vertical touching from the front	
¹⁾ In the case of deviations, please observe derating, see Equipment Manual in the chapter "Configuring".				
Terminal		3RW402., 3RW403., 3RW404.		
Control electronics				
Rated values				
Rated control supply voltage	A1/A2	V	24 AC/DC	110 ... 230 AC/DC
<ul style="list-style-type: none"> Tolerance 		%	± 20	-15/+10
Rated frequency		Hz	50/60	
<ul style="list-style-type: none"> Tolerance 		%	± 10	
Type			3RW402.-..B.4, 3RW403.-..B.4, 3RW404.-..B.4	3RW402.-..B.5, 3RW403.-..B.5, 3RW404.-..B.5
Power electronics				
Rated operational voltage		V AC	200 ... 480	400 ... 600
Tolerance		%	-15/+10	
Maximum blocking voltage (thyristor)		V AC	1 600	
Rated frequency		Hz	50/60	
Tolerance		%	± 10	
Uninterrupted duty at 40 °C (% of I_g)		%	115	
Minimum load (% of smallest adjustable rated motor current I_M)		%	20 (at least 2 A)	
Maximum cable length between soft starter and motor		m	300	

Switching devices – Soft starters and solid-state switching devices

SIRIUS 3RW soft starters

Basic Performance soft starters

3RW40 soft starters > General data

Type		3RW4024	3RW4026	3RW4027	3RW4028
Power electronics					
Load rating with rated operational current I_e					
• According to IEC and UL/CSA ¹⁾ , individual mounting at 40/50/60 °C, AC-53a	A	12.5/11/10	25.3/23/21	32.2/29/26	38/34/31
Smallest adjustable rated motor current I_M					
For the motor overload protection	A	5	10	17	23
Power loss					
• In operation after completed starting with uninterrupted rated operational current (40 °C) approx.	W	2	8	13	19
• During starting with current limiting set to 300% I_M (40 °C)	W	68	188	220	256
Permissible rated motor current and starts per hour					
• For normal starting (CLASS 10) at 40/50 °C					
- Rated motor current $I_M^{(2)}$, start-up time 3 s	A	12.5/11	25/23	32/29	38/34
- Starts per hour ³⁾	1/h	50/50	23/23	23/23	19/19
- Rated motor current $I_M^{(2)}$, start-up time 4 s	A	12.5/11	25/23	32/29	38/34
- Starts per hour ³⁾	1/h	36/36	15/15	16/16	12/12
• For heavy starting (CLASS 20) at 40/50 °C					
- Rated motor current $I_M^{(2)}$, start-up time 6 s	A	10/9	21/19	27/24	31/28
- Starts per hour ³⁾	1/h	47/47	21/21	20/20	18/18
- Rated motor current $I_M^{(2)}$, start-up time 8 s	A	10/9	21/19	27/24	31/28
- Starts per hour ³⁾	1/h	34/34	15/15	14/14	13/13
¹⁾ Measurement at 60 °C according to UL/CSA not required. ²⁾ Current limiting on soft starter set to 300% I_M , $T_U = 40/50$ °C. Maximum adjustable rated motor current I_M dependent on CLASS setting. ³⁾ For intermittent duty S4 with ON period = 30%, $T_U = 40/50$ °C, stand-alone installation vertical. The quoted switching frequencies do not apply for automatic mode. Factors for permissible switching frequency in other mounting position, direct mounting, side-by-side mounting, and implementation of optional auxiliary fan, see Equipment Manual in the chapter "Configuring" .					

Type		3RW4036	3RW4037	3RW4038	3RW4046	3RW4047
Power electronics						
Load rating with rated operational current I_e						
• According to IEC and UL/CSA ¹⁾ , individual mounting at 40/50/60 °C, AC-53a	A	45/42/39	63/58/53	72/62.1/60	80/73/66	106/98/90
Smallest adjustable rated motor current I_M						
For the motor overload protection	A	23	26	35	43	46
Power loss						
• In operation after completed starting with uninterrupted rated operational current (40 °C) approx.	W	6	12	15	12	21
• During starting with current limiting set to 300% I_M (40 °C)	W	316	444	500	576	768
Permissible rated motor current and starts per hour						
• For normal starting (CLASS 10) at 40/50 °C						
- Rated motor current $I_M^{(2)}$, start-up time 3 s	A	45/42	63/58	72/62	80/73	106/98
- Starts per hour ³⁾	1/h	38/38	23/23	22/22	22/22	15/15
- Rated motor current $I_M^{(2)}$, start-up time 4 s	A	45/42	63/58	72/62	80/73	106/98
- Starts per hour ³⁾	1/h	26/26	15/15	15/15	15/15	10/10
• For heavy starting (CLASS 20) at 40/50 °C						
- Rated motor current $I_M^{(2)}$, start-up time 6 s	A	38/34	46/42	50/46	64/58	77/70
- Starts per hour ³⁾	1/h	30/30	31/31	34/34	23/23	23/23
- Rated motor current $I_M^{(2)}$, start-up time 8 s	A	38/34	46/42	50/46	64/58	77/70
- Starts per hour ³⁾	1/h	21/21	22/22	24/24	16/16	16/16
¹⁾ Measurement at 60 °C according to UL/CSA not required. ²⁾ Current limiting on soft starter set to 300% I_M , $T_U = 40/50$ °C. Maximum adjustable rated motor current I_M dependent on CLASS setting. ³⁾ For intermittent duty S4 with ON period = 30%, $T_U = 40/50$ °C, stand-alone installation vertical. The quoted switching frequencies do not apply for automatic mode. Factors for permissible switching frequency in other mounting position, direct mounting, side-by-side mounting, and implementation of optional auxiliary fan, see Equipment Manual in the chapter "Configuring" .						

Switching devices – Soft starters and solid-state switching devices

SIRIUS 3RW soft starters
Basic Performance soft starters

3RW40 soft starters > General data

Motor feeders according to IEC with 3RV2 motor starter protectors (without semiconductor protection)

Type of coordination "1", CLASS 10,
short-circuit breaking capacity I_q in kA, [see table](#)

Note:

For general recommendations for constructing motor feeders
with soft starters, [see page 6/11](#).

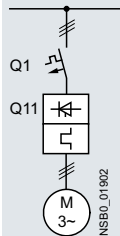

Soft starters	Motor starter protectors			
	for 400 V systems		for 500 V systems	
Q11	Q1	I_q	Q1	I_q
Type	Type	kA	Type	kA
Type of coordination "1"	Inline circuit			
3RW4024	3RV2021-4AA10	55	3RV2021-4AA10	10
3RW4026	3RV2021-4DA10	55	3RV2021-4DA10	10
3RW4027	3RV2021-4EA10	55	3RV2021-4EA10	10
3RW4028	3RV2021-4FA10	55	3RV2021-4FA10	10
3RW4036	3RV2031-4WA10	10	3RV2031-4WA10	10
3RW4037	3RV2031-4JA10	10	3RV2031-4JA10	5
3RW4038	3RV2031-4KA10	10	3RV2031-4KA10	5
3RW4046	3RV2041-4RA10	11	3RV2041-4YA10	5
3RW4047	3RV2041-4MA10	11	3RV2041-4MA10	5

Note:

The specified short-circuit breaking capacities I_q in kA are covered by combination tests. Smaller motor starter protectors/circuit breakers from the same series can be used at any time as smaller ones trip more quickly in the event of a short circuit (unchanged short-circuit breaking capacity) and thus protect the soft starter in any case. The dimensioning of the short-circuit components must match the connected three-phase motor, the short-circuit and overload requirements of the application, and the line protection for the cables used.

Switching devices – Soft starters and solid-state switching devices

SIRIUS 3RW soft starters

Basic Performance soft starters

3RW40 soft starters > General data

Motor feeders according to IEC with 3NA3 fuses

gG class full-range fuses for cable and line protection according to IEC 60269-2, without semiconductor protection

Type of coordination "1",
short-circuit breaking capacity $I_{q1} = 65 \text{ kA}$

Note:

For general recommendations for constructing motor feeders with soft starters, [see page 6/11](#).

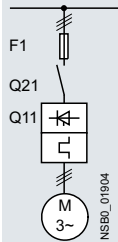

Soft starters	gG class fuse		Line contactor (optional)	
	for systems up to 600 V	for systems up to 400 V	for systems up to 480 V	for systems up to 600 V
Q11	F1	Q21	Q21	Q21
Type	Type	Type	Type	Type
Type of coordination "1"	<div style="border: 1px solid black; padding: 2px; display: inline-block;">T_{QC} 1</div> Inline circuit			
3RW4024	3NA3820-6	3RT2025	3RT2025/ 3RT2018 (in size S00)	3RT2025
3RW4026	3NA3822-6	3RT2026	3RT2027	3RT2037
3RW4027	3NA3824-6	3RT2027	3RT2028	3RT2037
3RW4028	3NA3824-6	3RT2028	3RT2035	3RT2037
3RW4036	3NA3130-6	3RT2036	3RT2036	3RT2038
3RW4037	3NA3132-6	3RT2037	3RT2037	3RT2046
3RW4038	3NA3132-6	3RT2038	3RT2038	3RT2046
3RW4046	3NA3136-6	3RT2045	3RT2045	3RT2047
3RW4047	3NA3136-6	3RT2047	3RT2047	3RT1054

Note:

The specified short-circuit breaking capacities I_{q1} in kA are covered by combination tests. Smaller fuses than those specified can be used at any time as smaller ones trip more quickly in the event of a short circuit (unchanged short-circuit breaking capacity) and thus protect the soft starter in any case. The dimensioning of the short-circuit components must, however, be suitable for the connected three-phase motor and the line protection for the cables used.

Switching devices – Soft starters and solid-state switching devices

SIRIUS 3RW soft starters
Basic Performance soft starters

3RW40 soft starters > General data

Motor feeders according to IEC with 3NE1 SITOR fuses

gR class full-range fuses for semiconductor protection, cable and line protection

Type of coordination "2",
short-circuit breaking capacity $I_{q} = 65 \text{ kA}$

Note:

For general recommendations for constructing motor feeders with soft starters, [see page 6/11](#).

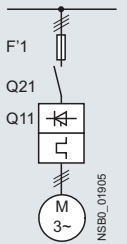

Soft starters	gR class fuse	Line contactor (optional)		
	for systems up to 600 V	for systems up to 400 V	for systems up to 480 V	for systems up to 600 V
Q11	F'1	Q21	Q21	Q21
Type	Type	Type	Type	Type
Type of coordination "2"	Inline circuit			
				
3RW4024	3NE1814-0	3RT2025	3RT2025/ 3RT2018 (in size S00)	3RT2025
3RW4026	3NE1803-0	3RT2026	3RT2027	3RT2037
3RW4027	3NE1020-2	3RT2027	3RT2028	3RT2037
3RW4028	3NE1020-2	3RT2028	3RT2035	3RT2037
3RW4036	3NE1020-2	3RT2036	3RT2036	3RT2038
3RW4037	3NE1820-0	3RT2037	3RT2037	3RT2046
3RW4038	3NE1820-0	3RT2038	3RT2038	3RT2046
3RW4046	3NE1021-0	3RT2045	3RT2045	3RT2047
3RW4047	3NE1022-0	3RT2047	3RT2047	3RT1054

Note:

The specified short-circuit breaking capacities I_{q} in kA are covered by combination tests. Smaller fuses than those specified can be used at any time as smaller ones trip more quickly in the event of a short circuit (unchanged short-circuit breaking capacity) and thus protect the soft starter in any case. The dimensioning of the short-circuit components must, however, be suitable for the connected three-phase motor and the line protection for the cables used.

Switching devices – Soft starters and solid-state switching devices

SIRIUS 3RW soft starters

Basic Performance soft starters

3RW40 soft starters > General data

Motor feeders according to IEC with 3NE8 / 3NE4 / 3NE3 / 3NC fuses

aR class partial-range fuses for semiconductor protection

Type of coordination "2",
short-circuit breaking capacity $I_q = 65 \text{ kA}$

Note:

For general recommendations for constructing motor feeders with soft starters, [see page 6/11](#).

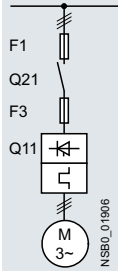

Soft starters	gG class fuse		aR class fuse		Cylindrical fuses	Line contactor (optional)		
	for systems up to 600 V	for systems up to 600 V	for systems up to 600 V	for systems up to 600 V		for systems up to 480 V	for systems up to 400 V	for systems up to 480 V
Q11	F1	F3	F3	F3	F3	Q21	Q21	Q21
Type	Type	Type	Type	Type	Type	Type	Type	Type
Type of coordination "2"	Inline circuit							
3RW4024	3NA3820-6	--	3NE4101	3NE8015-1	3NC2240	3RT2025	3RT2025/ 3RT2018 (in size S00)	3RT2025
3RW4026	3NA3822-6	--	3NE4102	3NE8017-1	3NC2263	3RT2026	3RT2027	3RT2037
3RW4027	3NA3824-6	--	3NE4118	3NE8018-1	3NC2280	3RT2027	3RT2028	3RT2037
3RW4028	3NA3824-6	--	3NE4118	3NE8020-1	3NC2280	3RT2028	3RT2035	3RT2037
3RW4036	3NA3130-6	--	3NE4120	3NE8020-1	3NC2280	3RT2036	3RT2036	3RT2038
3RW4037	3NA3132-6	--	3NE4121	3NE8021-1	--	3RT2037	3RT2037	3RT2046
3RW4038	3NA3132-6	3NE3221	--	3NE8022-1	--	3RT2038	3RT2038	3RT2046
3RW4046	3NA3136-6	3NE3222	--	3NE8022-1	--	3RT2045	3RT2045	3RT2047
3RW4047	3NA3136-6	3NE3224	--	3NE8024-1	--	3RT2047	3RT2047	3RT1054

Note:

The specified short-circuit breaking capacities I_q in kA are covered by combination tests. Smaller fuses than those specified can be used at any time as smaller ones trip more quickly in the event of a short circuit (unchanged short-circuit breaking capacity) and thus protect the soft starter in any case. The dimensioning of the short-circuit components must, however, be suitable for the connected three-phase motor and the line protection for the cables used.

For CLASS 10 applications, as an alternative to the gG class full-range fuses for cable and line protection 3NA3 (F1), 3RV2 motor starter protectors can also be used, possibly with reduced short-circuit breaking capacity ([see page 6/87](#)). In these cases, optional line contactors can be dispensed with.

Switching devices – Soft starters and solid-state switching devices

SIRIUS 3RW soft starters
Basic Performance soft starters

IE3/IE4 ready 3RW40 soft starters > Inline circuit

Selection and ordering data

For normal starting (CLASS 10)



3RW402.



3RW403.



3RW404.

3RW ambient temperature 40 °C				3RW ambient temperature 50 °C				Size	SD ¹⁾	Article No.	Price per PU	PU (UNIT, SET, M)	PS*	PG
Rated values of three-phase motors				Rated values of three-phase motors										
Operational current I_e	Rating at operational voltage U_e			Operational current I_e	Rating at operational voltage U_e			d						
	230 V	400 V	500 V		200 V	230 V	460 V							575 V
A	kW	kW	kW	A	hp	hp	hp	hp						
Rated operational voltage U_e 200 ... 480 V														
12.5	3	5.5	--	11	3	3	7.5	--	S0	▶	3RW4024-□BB□4	1	1 unit	42G
25	5.5	11	--	23	5	5	15	--	S0	▶	3RW4026-□BB□4	1	1 unit	42G
32	7.5	15	--	29	7.5	7.5	20	--	S0	▶	3RW4027-□BB□4	1	1 unit	42G
38	11	18.5	--	34	10	10	25	--	S0	▶	3RW4028-□BB□4	1	1 unit	42G
45	11	22	--	42	10	15	30	--	S2	▶	3RW4036-□BB□4	1	1 unit	42G
63	18.5	30	--	58	15	20	40	--	S2	▶	3RW4037-□BB□4	1	1 unit	42G
72	22	37	--	62	20	20	40	--	S2	▶	3RW4038-□BB□4	1	1 unit	42G
80	22	45	--	73	20	25	50	--	S3	▶	3RW4046-□BB□4	1	1 unit	42G
106	30	55	--	98	30	30	75	--	S3	▶	3RW4047-□BB□4	1	1 unit	42G
Rated operational voltage U_e 400 ... 600 V														
12.5	--	5.5	7.5	11	--	--	7.5	10	S0	5	3RW4024-□BB□5	1	1 unit	42G
25	--	11	15	23	--	--	15	20	S0	5	3RW4026-□BB□5	1	1 unit	42G
32	--	15	18.5	29	--	--	20	25	S0	5	3RW4027-□BB□5	1	1 unit	42G
38	--	18.5	22	34	--	--	25	30	S0	5	3RW4028-□BB□5	1	1 unit	42G
45	--	22	30	42	--	--	30	40	S2	5	3RW4036-□BB□5	1	1 unit	42G
63	--	30	37	58	--	--	40	50	S2	5	3RW4037-□BB□5	1	1 unit	42G
72	--	37	45	62	--	--	40	60	S2	5	3RW4038-□BB□5	1	1 unit	42G
80	--	45	55	73	--	--	50	60	S3	5	3RW4046-□BB□5	1	1 unit	42G
106	--	55	75	98	--	--	75	75	S3	5	3RW4047-□BB□5	1	1 unit	42G

Article No. supplement for connection types

- Screw terminals
- Spring-loaded terminals²⁾

Control supply voltage

- 24 V AC/DC
- 110 ... 230 V AC/DC

¹⁾ Soft starter U_e 200 to 480 V with screw terminals:
Standard delivery time SD = 1 day (d).

²⁾ Main connection from size S2: screw terminals.

Note:

For the constraints for the motor outputs specified here, see page 6/8.

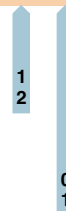

Switching devices – Soft starters and solid-state switching devices

SIRIUS 3RW soft starters

Basic Performance soft starters

3RW40 soft starters > Inline circuit **IE3/IE4 ready**

For normal starting (CLASS 10)



3RW402.



3RW403.



3RW404.

3RW ambient temperature 40 °C				3RW ambient temperature 50 °C				Size	SD ¹⁾	Article No.	Price per PU	PU (UNIT, SET, M)	PS*	PG
Rated values of three-phase motors				Rated values of three-phase motors										
Operational current I_e	Rating at operational voltage U_e			Operational current I_e	Rating at operational voltage U_e			d						
	230 V	400 V	500 V		200 V	230 V	460 V							575 V
A	kW			A	hp									
Rated operational voltage U_e 200 ... 480 V, with thermistor motor protection, rated control supply voltage U_s 24 V AC/DC														
12.5	3	5.5	--	11	3	3	7.5	--	S0	▶	3RW4024-□TB04	1	1 unit	42G
25	5.5	11	--	23	5	5	15	--	S0	▶	3RW4026-□TB04	1	1 unit	42G
32	7.5	15	--	29	7.5	7.5	20	--	S0	5	3RW4027-□TB04	1	1 unit	42G
38	11	18.5	--	34	10	10	25	--	S0	▶	3RW4028-□TB04	1	1 unit	42G
45	11	22	--	42	10	15	30	--	S2	▶	3RW4036-□TB04	1	1 unit	42G
63	18.5	30	--	58	15	20	40	--	S2	▶	3RW4037-□TB04	1	1 unit	42G
72	22	37	--	62	20	20	40	--	S2	▶	3RW4038-□TB04	1	1 unit	42G
80	22	45	--	73	20	25	50	--	S3	▶	3RW4046-□TB04	1	1 unit	42G
106	30	55	--	98	30	30	75	--	S3	▶	3RW4047-□TB04	1	1 unit	42G
Rated operational voltage U_e 400 ... 600 V, with thermistor motor protection, rated control supply voltage U_s 24 V AC/DC														
12.5	--	5.5	7.5	11	--	--	7.5	10	S0	5	3RW4024-□TB05	1	1 unit	42G
25	--	11	15	23	--	--	15	20	S0	5	3RW4026-□TB05	1	1 unit	42G
32	--	15	18.5	29	--	--	20	25	S0	5	3RW4027-□TB05	1	1 unit	42G
38	--	18.5	22	34	--	--	25	30	S0	5	3RW4028-□TB05	1	1 unit	42G
45	--	22	30	42	--	--	30	40	S2	5	3RW4036-□TB05	1	1 unit	42G
63	--	30	37	58	--	--	40	50	S2	5	3RW4037-□TB05	1	1 unit	42G
72	--	37	45	62	--	--	40	60	S2	5	3RW4038-□TB05	1	1 unit	42G
80	--	45	55	73	--	--	50	60	S3	5	3RW4046-□TB05	1	1 unit	42G
106	--	55	75	98	--	--	75	75	S3	5	3RW4047-□TB05	1	1 unit	42G

Article No. supplement for connection types

- Screw terminals
- Spring-loaded terminals²⁾

¹⁾ Soft starter U_e 200 to 480 V with screw terminals:
Standard delivery time SD = 1 day (d).

²⁾ Main connection from size S2: screw terminals.

Note:

For the constraints for the motor outputs specified here, see page 6/8.





1
2

Switching devices – Soft starters and solid-state switching devices

SIRIUS 3RW soft starters
Basic Performance soft starters

3RW40 soft starters > Accessories

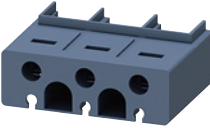
Selection and ordering data

Conductor cross-section		Tightening torque	For soft starters size	SD	Article No.	Price per PU	PU (UNIT, SET, M)	PS*	PG
Solid or stranded	Finely stranded with end sleeve								
mm ²	mm ²	AWG	Nm	d					
3-phase infeed terminals									
	2.5 ... 25	2.5 ... 16	10 ... 4	3 ... 4	S0 (3RW402.)				
3RV2925-5AB							1	1 unit	41E
Auxiliary terminals									
	Auxiliary terminals, 3-pole								
3RW404.	S3	For connection of auxiliary and control cables (0.5 ... 2.5 mm ²) to the main conductor terminals		2	3RT2946-4F		1	1 unit	41B
3RT2946-4F									
Covers for soft starters									
	Terminal covers for box terminals								
3RW403.	S2	Additional touch protection to be fitted at the box terminals (two units required per device)		▶	3RT2936-4EA2		1	1 unit	41B
3RW404.	S3				▶	3RT2946-4EA2		1	1 unit
3RT2936-4EA2									
	Terminal covers for cable lugs and busbar connections								
3RW404.	S3	For complying with the voltage clearances and as touch protection if box terminal is removed (two units required per device)		20	3RT1946-4EA1		1	1 unit	41B
3RT1946-4EA1									
	Sealing covers								
3RW402. to 3RW404.	S0, S2, S3	--		2	3RW4900-0PB10		1	1 unit	42G
3RW4900-0PB10									

Switching devices – Soft starters and solid-state switching devices

SIRIUS 3RW soft starters

Basic Performance soft starters

3RW40 soft starters > Accessories

For motor starter protectors	For soft starters	Version	SD	Article No.	Price per PU	PU (UNIT, SET, M)	PS*	PG
Size	Size		d					

Standard mounting rail adapters



3RA2932-1CA00

S2	S2	For mechanical fixing of motor starter protector and soft starter; for snapping onto standard mounting rail or for screw fixing Single-unit packaging	2	3RA2932-1CA00		1	1 unit	41B
-----------	-----------	---	---	----------------------	--	---	--------	-----

For soft starters	Version	SD	Article No.	Price per PU	PU (UNIT, SET, M)	PS*	PG
Type	Size	d					

Fans (to increase switching frequency and for device mounting in positions different to the standard position)



3RW49..-8VB00

3RW402.	S0	▶	3RW4928-8VB00		1	1 unit	42G
3RW403., 3RW404.	S2, S3	▶	3RW4947-8VB00		1	1 unit	42G

For soft starters	Motor starter protectors	SD	Article No.	Price per PU	PU (UNIT, SET, M)	PS*	PG
Type	Size	Size	d				

Link modules to motor starter protectors¹⁾

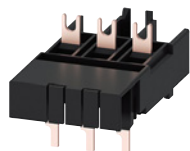

3RA2921-1BA00

• Screw terminals				Screw terminals				
3RW402.	S0	S00/S0	▶	3RA2921-1BA00		1	1 unit	41B
3RW4036	S2	S2	▶	3RA2931-1AA00		1	1 unit	41B
3RW404.	S3	S3	▶	3RA1941-1AA00		1	1 unit	41B
• Spring-loaded terminals				Spring-loaded terminals				
3RW402.	S0	S0	2	3RA2921-2GA00		1	1 unit	41B

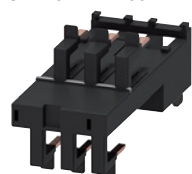

3RA2921-2GA00

- ¹⁾ Can be used in size S0 up to maximum 32 A.
Can be used in size S2 up to maximum 65 A in combination with 3RA2932-1CA00 standard mounting rail adapter (specially for soft starters).
Can be used in size S3 only with mounting plate.

Version	SD	Article No.	Price per PU	PU (UNIT, SET, M)	PS*	PG
d						

Tools for opening spring-loaded terminals in sizes S00 and S0



3RA2908-1A

Screwdrivers For all SIRIUS devices with spring-loaded terminals Length approx. 200 mm, 3.0 mm x 0.5 mm, titanium gray/black, partially insulated	2	Spring-loaded terminals		3RA2908-1A		1	1 unit	41B
---	---	--------------------------------	--	-------------------	--	---	--------	-----

Blank labels

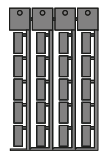

3RT2900-1SB20

Unit labeling plates¹⁾ For SIRIUS devices 20 mm x 7 mm, titanium gray	20	3RT2900-1SB20				100	340 units	41B
---	----	----------------------	--	--	--	-----	-----------	-----

- ¹⁾ PC labeling systems for individual inscription of unit labeling plates are available from: murrplastik Systemtechnik GmbH (see page 16/16).

Switching devices – Soft starters and solid-state switching devices

SIRIUS 3RW soft starters
Basic Performance soft starters

3RW30 soft starters > General data

Overview

More information

Homepage, see www.siemens.com/sirius-soft-starter
Industry Mall, see www.siemens.com/product?3RW30

TIA Selection Tool Cloud (TST Cloud), see <https://www.siemens.com/tstcloud/?node=3rw30>
Simulation Tool for Soft Starters (STS), see page 6/9 or <https://support.industry.siemens.com/cs/ww/en/view/101494917>



SIRIUS 3RW30 soft starter

The SIRIUS 3RW30 Basic Performance soft starters are suitable for soft starting of three-phase asynchronous motors.

Thanks to 2-phase control, not only is the current kept at minimum values in all three phases throughout the entire starting time, but disturbing direct current components are also eliminated. This not only enables the 2-phase starting of motors up to 55 kW (at 400 V) but also avoids the current and torque peaks which occur e.g. with wye-delta starters.

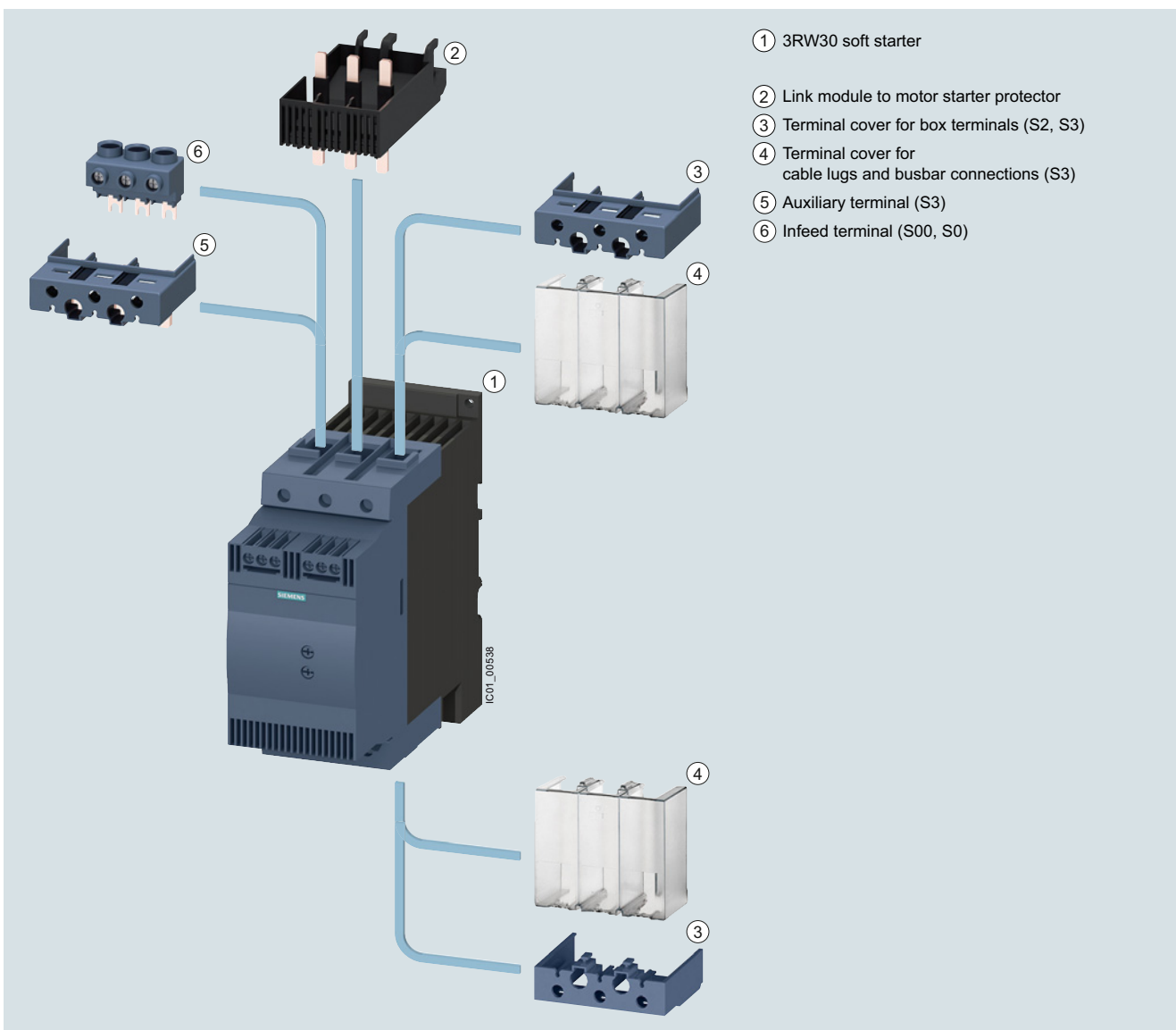

- ① 3RW30 soft starter
- ② Link module to motor starter protector
- ③ Terminal cover for box terminals (S2, S3)
- ④ Terminal cover for cable lugs and busbar connections (S3)
- ⑤ Auxiliary terminal (S3)
- ⑥ Infeed terminal (S00, S0)

SIRIUS 3RW30 Basic Performance soft starter with accessories (see page 6/104)

Switching devices – Soft starters and solid-state switching devices

SIRIUS 3RW soft starters

Basic Performance soft starters

3RW30 soft starters > General data

Benefits



3RW301.



3RW302.



3RW303.



3RW304.



3RW3003-2CB54

Product characteristics / function	Performance features / benefits
Small and compact design	Space-saving, clearly arranged control panel layout
Parameterization using potentiometers	Simple and fast commissioning
Integrated in the SIRIUS modular system	Link modules to motor starter protectors
Hybrid switching technology and 2-phase motor control	Minimum power loss and optimized motor control by avoiding DC components

Technical specifications

More information

Equipment Manual, see <https://support.industry.siemens.com/cs/ww/en/view/38752095>
 FAQs, see <https://support.industry.siemens.com/cs/ww/en/ps/16213/faq>

Catalog LV 10, see www.siemens.com/lowvoltage/lv10

Type		3RW301.	3RW302.	3RW303.	3RW304.	
Mechanics and environment						
Mounting dimensions (W x H x D)						
<ul style="list-style-type: none"> Screw terminals Spring-loaded terminals 		mm	45 x 95 x 151	45 x 125 x 151	55 x 144 x 168	70 x 160 x 186
		mm	45 x 117 x 151	45 x 150 x 151	55 x 144 x 168	70 x 160 x 186
Permissible ambient temperature						
During operation	°C	-25 ... +60; (derating from +40)				
During storage	°C	-40 ... +80				
Weight						
	kg	0.58	0.69	1.20	1.71	
Permissible mounting position¹⁾ (auxiliary fan not possible)						
Installation type¹⁾						
	Stand-alone installation					
		① ≥ 15 mm (≥ 0.59 in) ② ≥ 40 mm (≥ 1.56 in) ③ ≥ 60 mm (≥ 2.36 in)		① ≥ 30 mm (≥ 1.18 in) ② ≥ 40 mm (≥ 1.56 in) ③ ≥ 60 mm (≥ 2.36 in)		
Permissible installation altitude						
	m	5 000 (Derating from 1 000, see characteristic curve on page 6/9)				
Degree of protection IP on the front acc. to IEC 60529						
IP20						
Touch protection on the front acc. to IEC 60529						
Finger-safe for vertical touching from the front						

¹⁾ In the case of deviations, please observe derating, see Equipment Manual in the chapter "Configuring".

Switching devices – Soft starters and solid-state switching devices

SIRIUS 3RW soft starters
Basic Performance soft starters

3RW30 soft starters > General data

Type	Terminal	3RW301., 3RW302.		3RW303., 3RW304.			
Control electronics							
Rated values							
Rated control supply voltage	A1/A2	V	24	110 ... 230	24	110 ... 230	
• Tolerance		%	± 20	-15/+10	± 20	-15/+10	
Rated frequency		Hz	50/60				
• Tolerance		%	± 10				
Power electronics							
Rated operational voltage		V AC	200 ... 480				
Tolerance		%	-15/+10				
Rated frequency		Hz	50/60				
Tolerance		%	± 10				
Uninterrupted duty at 40 °C (% of I_e)		%	115				
Minimum load (% of I_e)		%	10 (at least 1 A)				
Maximum cable length between soft starter and motor		m	300				
Power electronics							
Load rating with rated operational current I_e							
• According to IEC and UL/CSA ¹⁾ , individual mounting at 40/50/60 °C, AC-53a	A		3.6/3.3/3	6.5/6/5.5	9/8/7	12.5/12/11	17.6/17/14
Power loss							
• In operation after completed starting with uninterrupted rated operational current (40 °C) approx.	W		0.25	0.5	1	2	4
• During starting with 300% I_M (40 °C)	W		24	52	80	80	116
Permissible rated motor current and starts per hour							
• For normal starting (CLASS 10) at 40/50 °C							
- Rated motor current I_M ²⁾ , start-up time 3 s	A		3.6/3.3	6.5/6.0	9/8	12.5/12.0	17.6/17.0
- Starts per hour ³⁾	1/h		200/150	87/60	50/50	85/70	62/46
- Rated motor current I_M ²⁾ , start-up time 4 s	A		3.6/3.3	6.5/6.0	9/8	12.5/12.0	17.6/17.0
- Starts per hour ³⁾	1/h		150/100	64/46	35/35	62/47	45/32
1) Measurement at 60 °C according to UL/CSA not required.			3) For intermittent duty S4 with ON period = 30%, $T_U = 40/50$ °C, stand-alone installation vertical. The quoted switching frequencies do not apply for automatic mode.				
2) At 300% I_M , $T_U = 40/50$ °C.							
Power electronics							
Load rating with rated operational current I_e							
• According to IEC and UL/CSA ¹⁾ , individual mounting at 40/50/60 °C, AC-53a	A		25.3/23/21	32.2/29/26	38/34/31		
Power loss							
• In operation after completed starting with uninterrupted rated operational current (40 °C) approx.	W		8	13	19		
• During starting with 300% I_M (40 °C)	W		188	220	256		
Permissible rated motor current and starts per hour							
• For normal starting (CLASS 10) at 40/50 °C							
- Rated motor current I_M ²⁾ , start-up time 3 s	A		25/23	32/29	38/34		
- Starts per hour ³⁾	1/h		23/23	23/23	19/19		
- Rated motor current I_M ²⁾ , start-up time 4 s	A		25/23	32/29	38/34		
- Starts per hour ³⁾	1/h		15/15	16/16	12/12		
1) Measurement at 60 °C according to UL/CSA not required.			3) For intermittent duty S4 with ON period = 30%, $T_U = 40/50$ °C, stand-alone installation vertical. The quoted switching frequencies do not apply for automatic mode. Factors for permissible switching frequency with deviating mounting position, direct mounting, side-by-side mounting, see Equipment Manual in the chapter "Configuring".				
2) At 300% I_M , $T_U = 40/50$ °C.							
Power electronics							
Load rating with rated operational current I_e							
• According to IEC and UL/CSA ¹⁾ , individual mounting at 40/50/60 °C, AC-53a	A		45/42/39	65/58/53	72/62.1/60	80/73/66	106/98/90
Power loss							
• In operation after completed starting with uninterrupted rated operational current (40 °C) approx.	W		6	12	15	12	21
• During starting with 300% I_M (40 °C)	W		316	444	500	576	768
Permissible rated motor current and starts per hour							
• For normal starting (CLASS 10) at 40/50 °C							
- Rated motor current I_M ²⁾ , start-up time 3 s	A		45/42	63/58	72/62	80/73	106/108
- Starts per hour ³⁾	1/h		38/38	23/23	22/22	22/22	15/15
- Rated motor current I_M ²⁾ , start-up time 4 s	A		45/42	63/58	72/62	80/73	106/98
- Starts per hour ³⁾	1/h		26/26	15/15	15/15	15/15	10/10
1) Measurement at 60 °C according to UL/CSA not required.			3) For intermittent duty S4 with ON period = 30%, $T_U = 40/50$ °C, stand-alone installation vertical. The quoted switching frequencies do not apply for automatic mode.				
2) At 300% I_M , $T_U = 40/50$ °C.							
Power electronics							
Load rating with rated operational current I_e							
• According to IEC and UL/CSA ¹⁾ , individual mounting at 40/50/60 °C, AC-53a	A		45/42/39	65/58/53	72/62.1/60	80/73/66	106/98/90
Power loss							
• In operation after completed starting with uninterrupted rated operational current (40 °C) approx.	W		6	12	15	12	21
• During starting with 300% I_M (40 °C)	W		316	444	500	576	768
Permissible rated motor current and starts per hour							
• For normal starting (CLASS 10) at 40/50 °C							
- Rated motor current I_M ²⁾ , start-up time 3 s	A		45/42	63/58	72/62	80/73	106/108
- Starts per hour ³⁾	1/h		38/38	23/23	22/22	22/22	15/15
- Rated motor current I_M ²⁾ , start-up time 4 s	A		45/42	63/58	72/62	80/73	106/98
- Starts per hour ³⁾	1/h		26/26	15/15	15/15	15/15	10/10
1) Measurement at 60 °C according to UL/CSA not required.			3) For intermittent duty S4 with ON period = 30%, $T_U = 40/50$ °C, stand-alone installation vertical. The quoted switching frequencies do not apply for automatic mode.				
2) At 300% I_M , $T_U = 40/50$ °C.							

Switching devices – Soft starters and solid-state switching devices

SIRIUS 3RW soft starters

Basic Performance soft starters

3RW30 soft starters > General data

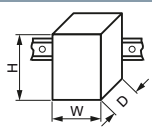
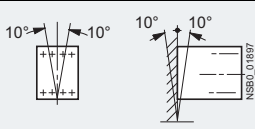
Type		3RW3003-1CB54	3RW3003-2CB54
Mechanics and environment			
Mounting dimensions (W x H x D)			
<ul style="list-style-type: none"> Screw terminals Spring-loaded terminals 		mm	22.5 x 100 x 120
		mm	--
Permissible ambient temperature			
During operation	°C	-25 ... +60; (derating from +40)	
During storage	°C	-40 ... +80	
Weight	kg	0.207	0.188
Permissible mounting position			
			
Permissible installation altitude	m	5 000 (Derating from 1 000, see characteristic curve on page 6/9)	
Degree of protection IP on the front acc. to IEC 60529		IP20	
Touch protection on the front acc. to IEC 60529		Finger-safe for vertical touching from the front	
Control electronics			
Rated values			
Rated control supply voltage	V	24 ... 230 AC/DC	
<ul style="list-style-type: none"> Tolerance 	%	± 10	
Rated frequency at AC	Hz	50/60	
<ul style="list-style-type: none"> Tolerance 	%	± 10	
Power electronics			
Rated operational voltage	V AC	200 ... 400	
Tolerance	%	± 10	
Rated frequency	Hz	50/60	
Tolerance	%	± 10	
Uninterrupted duty (% of I_e)	%	100	
Minimum load ¹⁾ (% of I_e); at 40 °C	%	9	
Maximum conductor length between soft starter and motor	m	100 ²⁾	
Load rating with rated operational current I_e			
<ul style="list-style-type: none"> According to IEC and UL/CSA, individual mounting at 40/50/60 °C, AC-53a 	A	3/2.6/2.2	
<ul style="list-style-type: none"> According to IEC and UL/CSA, side-by-side mounting at 40/50/60 °C, AC-53a 	A	2.6/2.2/1.8	
Power loss			
<ul style="list-style-type: none"> In operation after completed starting with uninterrupted rated operational current (40 °C) approx. 	W	6.5	
<ul style="list-style-type: none"> With utilization of maximum switching frequency 	W	3	
Permissible starts per hour (cannot be increased by using a fan)			
<ul style="list-style-type: none"> For intermittent duty S4 $T_{ij} = 40$ °C, stand-alone installation vertical 	1/h	1 500	
<ul style="list-style-type: none"> ON period = 70% for 300% I_e 	1/s	0.2	
Dead time after uninterrupted duty			
with I_e before restart	s	0	

¹⁾ The rated motor current (specified on the motor's name plate) should at least amount to the specified percentage of the SIRIUS soft starter unit's rated operational current I_e .

²⁾ If this value is exceeded, problems with line capacities may arise, which can result in false firing.

Switching devices – Soft starters and solid-state switching devices

SIRIUS 3RW soft starters
Basic Performance soft starters

3RW30 soft starters > General data

Motor feeders according to IEC with 3RV2 motor starter protectors (without semiconductor protection)

Type of coordination "1", CLASS 10,
short-circuit breaking capacity I_q in kA, [see table](#)

Note:

For general recommendations for constructing motor feeders
with soft starters, [see page 6/11](#).

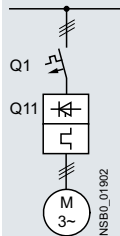

Soft starters	Motor starter protectors	
Q11	for 400 V systems	
Type	Q1	I_q kA
Type of coordination "1"	Inline circuit	
3RW3003	3RV2011-1EA10	50
3RW3013	3RV2011-1FA10	5
3RW3014	3RV2011-1HA10	5
3RW3016	3RV2011-1JA10	5
3RW3017	3RV2011-1KA10	5
3RW3018	3RV2021-4BA10	5
3RW3026	3RV2021-4DA10	55
3RW3027	3RV2021-4EA10	55
3RW3028	3RV2021-4FA10	55
3RW3036	3RV2031-4WA10	10
3RW3037	3RV2031-4JA10	10
3RW3038	3RV2031-4KA10	10
3RW3046	3RV2041-4RA10	11
3RW3047	3RV2041-4MA10	11

Note:

The specified short-circuit breaking capacities I_q in kA are covered by combination tests. Smaller motor starter protectors/circuit breakers from the same series can be used at any time as smaller ones trip more quickly in the event of a short circuit (unchanged short-circuit breaking capacity) and thus protect the soft starter in any case. The dimensioning of the short-circuit components must match the connected three-phase motor, the short-circuit and overload requirements of the application, and the line protection for the cables used.

Switching devices – Soft starters and solid-state switching devices

SIRIUS 3RW soft starters

Basic Performance soft starters

3RW30 soft starters > General data

Motor feeders according to IEC with 3NA3 fuses

gG class full-range fuses for cable and line protection according to IEC 60269-2, without semiconductor protection

Type of coordination "1",
short-circuit breaking capacity $I_{q} = 65$ kA

Note:

For general recommendations for constructing motor feeders with soft starters, see page 6/11.

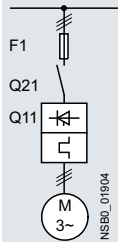

Soft starters	gG class fuse	Line contactor (optional)	
	for systems up to 480 V	for systems up to 400 V	for systems up to 480 V
Q11 Type	F1 Type	Q21 Type	Q21 Type
Type of coordination "1"	Inline circuit T_{QC} 1		
3RW3003¹⁾	3NA3805 ²⁾	3RT2015	3RT2015
3RW3013	3NA3803-6	3RT2015	3RT2015
3RW3014	3NA3805-6	3RT2015	3RT2016
3RW3016	3NA3807-6	3RT2016	3RT2017
3RW3017	3NA3810-6	3RT2018	3RT2025
3RW3018	3NA3814-6	3RT2026	3RT2026
3RW3026	3NA3822-6	3RT2026	3RT2027
3RW3027	3NA3824-6	3RT2027	3RT2028
3RW3028	3NA3824-6	3RT2028	3RT2035
3RW3036	3NA3130-6	3RT2036	3RT2036
3RW3037	3NA3132-6	3RT2037	3RT2037
3RW3038	3NA3132-6	3RT2038	3RT2038
3RW3046	3NA3136-6	3RT2045	3RT2045
3RW3047	3NA3136-6	3RT2047	3RT2047

¹⁾ $I_{q} = 50$ kA at 400 V.

²⁾ 3NA3805-1 (NH00), 5SB261 (DIAZED), 5SE2201-6 (NEOZED).

Note:

The specified short-circuit breaking capacities I_{q} in kA are covered by combination tests. Smaller fuses than those specified can be used at any time as smaller ones trip more quickly in the event of a short circuit (unchanged short-circuit breaking capacity) and thus protect the soft starter in any case. The dimensioning of the short-circuit components must, however, be suitable for the connected three-phase motor and the line protection for the cables used.

Motor feeders according to IEC with 3NE1 SITOR fuses

gR class full-range fuses for semiconductor protection,
cable and line protection

Type of coordination "2",
short-circuit breaking capacity $I_q = 65$ kA

Note:

For general recommendations for constructing motor feeders
with soft starters, see page 6/11.

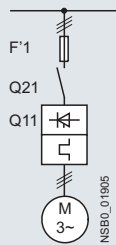

Soft starters	gR class fuse	Line contactor (optional)	
Q11	for systems up to 480 V	for systems up to 400 V	for systems up to 480 V
Type	F'1	Q21	Q21
Type	Type	Type	Type
Type of coordination "2"	Inline circuit TOC 2		
3RW3003 ¹⁾	3NE 1813-0 ²⁾	3RT2015	3RT2015
3RW3013	3NE 1813-0	3RT2015	3RT2015
3RW3014	3NE 1813-0	3RT2015	3RT2016
3RW3016	3NE 1813-0	3RT2016	3RT2017
3RW3017	3NE 1813-0	3RT2018	3RT2025
3RW3018	3NE 1814-0	3RT2026	3RT2026
3RW3026	3NE 1803-0	3RT2026	3RT2027
3RW3027	3NE 1020-2	3RT2027	3RT2028
3RW3028	3NE 1020-2	3RT2028	3RT2035
3RW3036	3NE 1020-2	3RT2036	3RT2036
3RW3037	3NE 1820-0	3RT2037	3RT2037
3RW3038	3NE 1820-0	3RT2038	3RT2038
3RW3046	3NE 1021-0	3RT2045	3RT2045
3RW3047	3NE 1022-0	3RT2047	3RT2047

¹⁾ $I_q = 50$ kA at 400 V.

²⁾ No SITOR fuse required!
Alternatively: 3NA3803 (NH00), 5SB221 (DIAZED), 5SE2206 (NEOZED).

Note:

The specified short-circuit breaking capacities I_q in kA are covered by combination tests. Smaller fuses than those specified can be used at any time as smaller ones trip more quickly in the event of a short circuit (unchanged short-circuit breaking capacity) and thus protect the soft starter in any case. The dimensioning of the short-circuit components must, however, be suitable for the connected three-phase motor and the line protection for the cables used.

Switching devices – Soft starters and solid-state switching devices

SIRIUS 3RW soft starters

Basic Performance soft starters

3RW30 soft starters > General data

Motor feeders according to IEC with 3NE8 / 3NE4 / 3NE3 / 3NC fuses

aR class partial-range fuses for semiconductor protection

Type of coordination "2",
short-circuit breaking capacity $I_q = 65$ kA

Note:

For general recommendations for constructing motor feeders with soft starters, [see page 6/11](#).

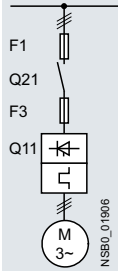

Soft starters	gG class fuse	aR class fuse			Cylindrical fuse	Line contactor (optional)	
	for systems up to 480 V	for systems up to 480 V	for systems up to 480 V	for systems up to 480 V	for systems up to 480 V	for systems up to 400 V	for systems up to 480 V
Q11	F1	F3	F3	F3	F3	Q21	Q21
Type	Type	Type	Type	Type	Type	Type	Type
Type of coordination "2"	Inline circuit						
3RW3003¹⁾	3NA3805 ²⁾	--	--	3NE8015-1	3NC1010	3RT2015	3RT2015
3RW3013	3NA3803-6	--	3NE4101	3NE8015-1	3NC2220	3RT2015	3RT2015
3RW3014	3NA3805-6	--	3NE4101	3NE8015-1	3NC2220	3RT2015	3RT2016
3RW3016	3NA3807-6	--	3NE4101	3NE8015-1	3NC2220	3RT2016	3RT2017
3RW3017	3NA3810-6	--	3NE4101	3NE8015-1	3NC2250	3RT2018	3RT2025
3RW3018	3NA3814-6	--	3NE4101	3NE8003-1	3NC2263	3RT2026	3RT2026
3RW3026	3NA3822-6	--	3NE4102	3NE8017-1	3NC2263	3RT2026	3RT2027
3RW3027	3NA3824-6	--	3NE4118	3NE8018-1	3NC2280	3RT2027	3RT2028
3RW3028	3NA3824-6	--	3NE4118	3NE8020-1	3NC2280	3RT2028	3RT2035
3RW3036	3NA3130-6	--	3NE4120	3NE8020-1	3NC2280	3RT2036	3RT2036
3RW3037	3NA3132-6	--	3NE4121	3NE8021-1	--	3RT2037	3RT2037
3RW3038	3NA3132-6	3NE3221	--	3NE8022-1	--	3RT2038	3RT2038
3RW3046	3NA3136-6	3NE3222	--	3NE8022-1	--	3RT2045	3RT2045
3RW3047	3NA3136-6	3NE3224	--	3NE8024-1	--	3RT2047	3RT2047

¹⁾ $I_q = 50$ kA at 400 V.

²⁾ 3NA3805-1 (NH00), 5SB261 (DIAZED).

Note:

The specified short-circuit breaking capacities I_q in kA are covered by combination tests. Smaller fuses than those specified can be used at any time as smaller ones trip more quickly in the event of a short circuit (unchanged short-circuit breaking capacity) and thus protect the soft starter in any case. The dimensioning of the short-circuit components must, however, be suitable for the connected three-phase motor and the line protection for the cables used.

For CLASS 10 applications, as an alternative to the gG class full-range fuses for cable and line protection 3NA3 (F1), 3RV2 motor starter protectors can also be used, possibly with reduced short-circuit breaking capacity ([see page 6/99](#)). In these cases, optional line contactors can be dispensed with.

Switching devices – Soft starters and solid-state switching devices

SIRIUS 3RW soft starters

Basic Performance soft starters

IE3/IE4 ready 3RW30 soft starters > Inline circuit

Selection and ordering data

For simple starting conditions



3RW ambient temperature 40 °C				3RW ambient temperature 50 °C				Size	SD ¹⁾	Article No.	Price per PU	PU (UNIT, SET, M)	PS*	PG
Rated values of three-phase motors				Rated values of three-phase motors										
Operational current I_e	Rating at operational voltage U_e			Operational current I_e	Rating at operational voltage U_e			d						
	230 V	400 V	500 V		200 V	230 V	460 V							575 V
A	kW	kW	kW	A	hp	hp	hp	hp						
Rated operational voltage U_e 200 ... 480 V														
3.6	0.75	1.5	--	3	0.5	0.5	1.5	--	S00	▶	3RW3013-□BB□4	1	1 unit	42G
6.5	1.5	3	--	6	1	1	3	--	S00	▶	3RW3014-□BB□4	1	1 unit	42G
9	2.2	4	--	8	2	2	5	--	S00	▶	3RW3016-□BB□4	1	1 unit	42G
12.5	3	5.5	--	12	3	3	7.5	--	S00	▶	3RW3017-□BB□4	1	1 unit	42G
17.6	4	7.5	--	17	3	3	10	--	S00	▶	3RW3018-□BB□4	1	1 unit	42G
25	5.5	11	--	23	5	5	15	--	S0	▶	3RW3026-□BB□4	1	1 unit	42G
32	7.5	15	--	29	7.5	7.5	20	--	S0	▶	3RW3027-□BB□4	1	1 unit	42G
38	11	18.5	--	34	10	10	25	--	S0	▶	3RW3028-□BB□4	1	1 unit	42G
45	11	22	--	42	10	15	30	--	S2	▶	3RW3036-□BB□4	1	1 unit	42G
63	18.5	30	--	58	15	20	40	--	S2	▶	3RW3037-□BB□4	1	1 unit	42G
72	22	37	--	62	20	20	40	--	S2	▶	3RW3038-□BB□4	1	1 unit	42G
80	22	45	--	73	20	25	50	--	S3	▶	3RW3046-□BB□4	1	1 unit	42G
106	30	55	--	98	30	30	75	--	S3	▶	3RW3047-□BB□4	1	1 unit	42G

Article No. supplement for connection types

- Screw terminals
- Spring-loaded terminals²⁾

Control supply voltage U_s

- 24 V AC/DC
- 110 ... 230 V AC/DC

Soft starters for easy starting conditions and high switching frequency, rated operational voltage U_e 200 ... 400 V, rated control supply voltage U_s 24 ... 230 V AC/DC

3	0.55	1.1	--	A	0.5	0.5	--	--	22.5 mm					
										▶	3RW3003-1CB54	1	1 unit	42G
										▶	3RW3003-2CB54	1	1 unit	42G

¹⁾ Soft starter U_e 200 to 480 V with screw terminals: Standard delivery time SD = 1 day (d).

²⁾ Main connection from size S2: screw terminals.

Note:

For the constraints for the motor outputs specified here, see page 6/8.

Switching devices – Soft starters and solid-state switching devices

SIRIUS 3RW soft starters







Basic Performance soft starters

3RW30 soft starters > Accessories

Selection and ordering data

More information

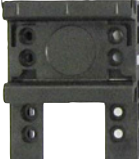
Equipment Manual, see <https://support.industry.siemens.com/cs/ww/en/view/38752095>

Solid or stranded	Conductor cross-section		Tightening torque	For soft starters size	SD	Article No.	Price per PU	PU (UNIT, SET, M)	PS*	PG
	mm ²	Finely stranded with end sleeve mm ²								
3-phase infeed terminals										
	2.5 ... 25	2.5 ... 16	10 ... 4	3 ... 4	S00 (3RW301.), S0 (3RW302.)	3RV2925-5AB		1	1 unit	41E
3RV2925-5AB										
For soft starters Type	Size				SD	Article No.	Price per PU	PU (UNIT, SET, M)	PS*	PG
Auxiliary terminals										
	Auxiliary terminals, 3-pole									
3RW304.	S3				2	3RT2946-4F		1	1 unit	41B
3RT2946-4F										
Covers for soft starters										
	Terminal covers for box terminals									
Additional touch protection to be fitted at the box terminals (two units required per device)										
3RW303.	S2					3RT2936-4EA2		1	1 unit	41B
3RW304.	S3					3RT2946-4EA2		1	1 unit	41B
3RT2946-4EA2										
	Terminal covers for cable lugs and busbar connections									
For complying with the voltage clearances and as touch protection if box terminal is removed (two units required per device)										
3RW304.	S3				20	3RT1946-4EA1		1	1 unit	41B
3RT1946-4EA1										
For motor starter protectors Size	For soft starters Size	Version			SD	Article No.	Price per PU	PU (UNIT, SET, M)	PS*	PG
Mounting rails for mounting contactors for the customer assembly of 3RA21 load feeders with busbar adapters for 60 mm systems										
	--	S0	For the discrete configuration of direct-on-line starters, an additional mounting rail is needed for the contactor in addition to the existing mounting rail on the busbar adapter for the motor starter protector.		2	8US1998-7CB45		1	10 units	140
8US1998-7CB45	For pushing onto the device adapter, including fixing screws									
Standard mounting rail adapters										
	S2	S2	For mechanical fixing of motor starter protector and soft starter; for snapping onto standard mounting rail or for screw fixing		2	3RA2932-1CA00		1	1 unit	41B
3RA2932-1CA00	Single-unit packaging									

Switching devices – Soft starters and solid-state switching devices

SIRIUS 3RW soft starters

Basic Performance soft starters

3RW30 soft starters > Accessories

For soft starters Type	Size	Motor starter protectors Size	SD	Article No.	Price per PU	PU (UNIT, SET, M)	PS*	PG
			d					

Link modules to motor starter protectors¹⁾

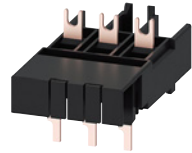

3RA2921-1BA00

• Screw terminals

3RW301.	S00	S00	▶	3RA2921-1BA00		1	1 unit	41B
3RW302.	S0	S00/S0	▶	3RA2921-1BA00		1	1 unit	41B
3RW3036	S2	S2	▶	3RA2931-1AA00		1	1 unit	41B
3RW304.	S3	S3	▶	3RA1941-1AA00		1	1 unit	41B

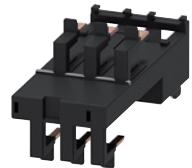

3RA2921-2GA00

• Spring-loaded terminals

3RW301.	S00	S00	2	3RA2911-2GA00		1	1 unit	41B
3RW302.	S0	S0	2	3RA2921-2GA00		1	1 unit	41B

Screw terminals



Spring-loaded terminals



- ¹⁾ Can be used in size S0 up to 32 A.
Can be used in size S2 up to 65 A in combination with 3RA2932-1CA00 standard mounting rail adapter (specially for soft starters).
Can be used in size S3 only on mounting plate.

Version	Functionality Functions	Use	SD	Article No.	Price per PU	PU (UNIT, SET, M)	PS*	PG
			d					

Covers and push-in lugs (only for 3RW3003)



3RP1902

Sealable covers	For securing against unauthorized adjustment of setting knobs	For devices with 1 or 2 CO contacts	5	3RP1902		1	5 units	41H
------------------------	---	-------------------------------------	---	----------------	--	---	---------	-----



3RP1903

Push-in lugs for screw fixing	--	For devices with 1 or 2 CO contacts	5	3RP1903		1	10 units	41H
--------------------------------------	----	-------------------------------------	---	----------------	--	---	----------	-----

Version	SD	Article No.	Price per PU	PU (UNIT, SET, M)	PS*	PG
	d					

Tools for opening spring-loaded terminals in sizes S00 and S0



3RA2908-1A

Screwdrivers

For all SIRIUS devices with spring-loaded terminals
Length approx. 200 mm, 3.0 mm x 0.5 mm, titanium gray/black, partially insulated

Spring-loaded terminals



2	3RA2908-1A		1	1 unit	41B
---	-------------------	--	---	--------	-----

Blank labels

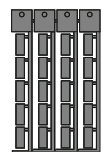

3RT2900-1SB20

Unit labeling plates¹⁾

For SIRIUS devices
20 mm x 7 mm, titanium gray

20	3RT2900-1SB20		100	340 units	41B
----	----------------------	--	-----	-----------	-----

- ¹⁾ PC labeling systems for individual inscription of unit labeling plates are available from: murrplastik Systemtechnik GmbH (see page 16/16).

Switching devices – Soft starters and solid-state switching devices

SIRIUS 3RW soft starters

Spare parts

For 3RW55/3RW55 Failsafe





Overview

More information

Homepage, see www.siemens.com/sirius-soft-starter
 Industry Mall, see www.siemens.com/product?3RW

Industry Online Support (SIOS) topic page, see
<https://support.industry.siemens.com/cs/ww/en/view/109747404>

Selection and ordering data





Product designation	Manufacturer's Article No. of the soft starter	Type of product	SD	Article No.	Price per PU	PU (UNIT, SET, M)	PS*	PG			
Power semiconductor modules											
	Power semiconductor module	3RW5524-.HA.4 (3x)	480 V, 47 A	▶	3RW5952-0SF04		1	1 unit	42S		
		3RW5525-.HA.4 (3x), 3RW5526-.HA.4 (3x)	480 V, 77 A	▶	3RW5952-0SH04		1	1 unit	42S		
		3RW5527-.HA.4 (3x)	480 V, 93 A	▶	3RW5952-0SJ04		1	1 unit	42S		
		3RW5534-.HA.4 (3x), 3RW5535-.HA.4 (3x)	480 V, 143 A	▶	3RW5953-0SL04		1	1 unit	42S		
		3RW5536-.HA.4 (3x)	480 V, 171 A	▶	3RW5953-0SM04		1	1 unit	42S		
		3RW5543-.HA.4 (3x)	480 V, 210 A	▶	3RW5954-0SN04		1	1 unit	42S		
		3RW5544-.HA.4 (3x)	480 V, 250 A	▶	3RW5954-0SP04		1	1 unit	42S		
		3RW5545-.HA.4 (3x), 3RW5546-.HA.4 (3x)	480 V, 370 A	▶	3RW5954-0SR04		1	1 unit	42S		
		3RW5547-.HA.4 (3x), 3RW5548-.HA.4 (3x)	480 V, 570 A	▶	3RW5954-0ST04		1	1 unit	42S		
		3RW5552-.HA.4 (3x)	480 V, 630 A	▶	3RW5955-0SU04		1	1 unit	42S		
		3RW5553-.HA.4 (3x)	480 V, 720 A	▶	3RW5955-0SV04		1	1 unit	42S		
		3RW5554-.HA.4 (3x)	480 V, 840 A	▶	3RW5955-0SW04		1	1 unit	42S		
		3RW5556-.HA.4 (3x)	480 V, 1 100 A	▶	3RW5955-0SX04		1	1 unit	42S		
		3RW5558-.HA.4 (3x)	480 V, 1 280 A	▶	3RW5955-0SY04		1	1 unit	42S		
			Power semiconductor module	3RW5521-.HA.6 (3x), 3RW5524-.HA.6 (3x)	690 V, 47 A	▶	3RW5952-0SF06		1	1 unit	42S
				3RW5525-.HA.6 (3x), 3RW5526-.HA.6 (3x)	690 V, 77 A	▶	3RW5952-0SH06		1	1 unit	42S
3RW5527-.HA.6 (3x)	690 V, 93 A			▶	3RW5952-0SJ06		1	1 unit	42S		
3RW5534-.HA.6 (3x), 3RW5535-.HA.6 (3x)	690 V, 143 A			▶	3RW5953-0SL06		1	1 unit	42S		
3RW5536-.HA.6 (3x)	690 V, 171 A			▶	3RW5953-0SM06		1	1 unit	42S		
3RW5543-.HA.6 (3x)	690 V, 210 A			▶	3RW5954-0SN06		1	1 unit	42S		
3RW5544-.HA.6 (3x)	690 V, 250 A			▶	3RW5954-0SP06		1	1 unit	42S		
3RW5545-.HA.6 (3x), 3RW5546-.HA.6 (3x)	690 V, 370 A			▶	3RW5954-0SR06		1	1 unit	42S		
3RW5547-.HA.6 (3x), 3RW5548-.HA.6 (3x)	690 V, 570 A			▶	3RW5954-0ST06		1	1 unit	42S		
3RW5552-.HA.6 (3x)	690 V, 630 A			▶	3RW5955-0SU06		1	1 unit	42S		
3RW5553-.HA.6 (3x)	690 V, 720 A			▶	3RW5955-0SV06		1	1 unit	42S		
3RW5554-.HA.6 (3x)	690 V, 840 A			▶	3RW5955-0SW06		1	1 unit	42S		
3RW5556-.HA.6 (3x)	690 V, 1 100 A			▶	3RW5955-0SX06		1	1 unit	42S		
3RW5558-.HA.6 (3x)	690 V, 1 280 A			▶	3RW5955-0SY06		1	1 unit	42S		
	Power semiconductor module			3RW5521-.HA.6 (3x), 3RW5524-.HA.6 (3x)	690 V, 47 A	▶	3RW5952-0SF06		1	1 unit	42S
				3RW5525-.HA.6 (3x), 3RW5526-.HA.6 (3x)	690 V, 77 A	▶	3RW5952-0SH06		1	1 unit	42S
		3RW5527-.HA.6 (3x)	690 V, 93 A	▶	3RW5952-0SJ06		1	1 unit	42S		
		3RW5534-.HA.6 (3x), 3RW5535-.HA.6 (3x)	690 V, 143 A	▶	3RW5953-0SL06		1	1 unit	42S		
		3RW5536-.HA.6 (3x)	690 V, 171 A	▶	3RW5953-0SM06		1	1 unit	42S		
		3RW5543-.HA.6 (3x)	690 V, 210 A	▶	3RW5954-0SN06		1	1 unit	42S		
		3RW5544-.HA.6 (3x)	690 V, 250 A	▶	3RW5954-0SP06		1	1 unit	42S		
		3RW5545-.HA.6 (3x), 3RW5546-.HA.6 (3x)	690 V, 370 A	▶	3RW5954-0SR06		1	1 unit	42S		
3RW5547-.HA.6 (3x), 3RW5548-.HA.6 (3x)	690 V, 570 A	▶	3RW5954-0ST06		1	1 unit	42S				
	Bypass unit	3RW552-.HA..., 3RW553-.HA...	--	▶	3RW5953-0BY00		1	1 unit	42S		
		3RW5543-.HA..., 3RW5544-.HA..., 3RW5545-.HA...	210 ... 315 A	▶	3RW5954-0BP00		1	1 unit	42S		
		3RW5546-.HA..., 3RW5547-.HA..., 3RW5548-.HA...	370 ... 570 A	▶	3RW5954-0BT00		1	1 unit	42S		
		3RW5552, 3RW5553, 3RW5554	630 ... 840 A	▶	3RW5955-0BW00		1	1 unit	42S		
		3RW5556, 3RW5558	1 100 A, 1 280 A	▶	3RW5955-0BY00		1	1 unit	42S		

Switching devices – Soft starters and solid-state switching devices

SIRIUS 3RW soft starters

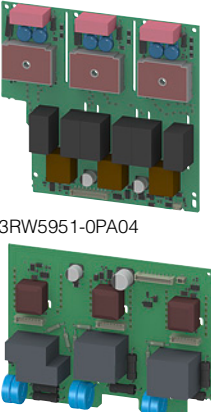
Spare parts

For 3RW55/3RW55 Failsafe







Product designation	Manufacturer's Article No. of the soft starter	Type of product	SD	Article No.	Price per PU	PU (UNIT, SET, M)	PS*	PG	
Control units									
	Control unit	3RW551.-.HA0., 3RW552.-.HA0., 3RW553.-.HA0., 3RW554.-.HA0.	24 V	▶	3RW5950-1UY00		1	1 unit	42S
		3RW555.-.HA0.		▶	3RW5955-1UY00		1	1 unit	42S
		3RW551.-.HA1., 3RW552.-.HA1., 3RW553.-.HA1., 3RW554.-.HA1.	110 ... 250 V	▶	3RW5950-1UY10		1	1 unit	42S
		3RW555.-.HA1.		▶	3RW5955-1UY10		1	1 unit	42S
Printed circuit boards									
	Printed circuit boards	3RW5513-.HA.4	480 V, 13 A	▶	3RW5951-0PA04		1	1 unit	42S
		3RW5514-.HA.4	480 V, 18 A	▶	3RW5951-0PB04		1	1 unit	42S
		3RW5515-.HA.4	480 V, 25 A	▶	3RW5951-0PC04		1	1 unit	42S
		3RW5516-.HA.4	480 V, 32 A	▶	3RW5951-0PD04		1	1 unit	42S
		3RW5517-.HA.4	480 V, 38 A	▶	3RW5951-0PE04		1	1 unit	42S
		3RW552.-.HA.4, 3RW553.-.HA.4	480 V	▶	3RW5953-0PY04		1	1 unit	42S
		3RW554.-.HA.4	480 V	▶	3RW5954-0PY04		1	1 unit	42S
		3RW5513-.HA.5	600 V, 13 A	▶	3RW5951-0PA05		1	1 unit	42S
		3RW5514-.HA.5	600 V, 18 A	▶	3RW5951-0PB05		1	1 unit	42S
		3RW5515-.HA.5	600 V, 25 A	▶	3RW5951-0PC05		1	1 unit	42S
		3RW5516-.HA.5	600 V, 32 A	▶	3RW5951-0PD05		1	1 unit	42S
		3RW5517-.HA.5	600 V, 38 A	▶	3RW5951-0PE05		1	1 unit	42S
		3RW552.-.HA.6, 3RW553.-.HA.6	690 V	▶	3RW5953-0PY06		1	1 unit	42S
		3RW554.-.HA.6	690 V	▶	3RW5954-0PY06		1	1 unit	42S
Firing printed circuit boards	3RW555.-.HA.4	480 V	▶	3RW5955-0PY14		1	1 unit	42S	
	3RW555.-.HA.6	690 V	▶	3RW5955-0PY16		1	1 unit	42S	
TSE printed circuit boards	3RW555.-.HA.4	480 V	▶	3RW5955-0PY24		1	1 unit	42S	
	3RW555.-.HA.6	690 V	▶	3RW5955-0PY26		1	1 unit	42S	
Fans									
	Fan	3RW551 (1x), 3RW552 (2x), 3RW553 (2x)	--	▶	3RW5983-0FF00		1	1 unit	42S
		3RW554 (1x)	--	▶	3RW5984-0FF00		1	1 unit	42S
		3RW555 (3x)	--	▶	3RW5985-0FF00		1	1 unit	42S
Terminals and terminal covers									
	Box terminal block	3RW552 (2x)	--	▶	3RW5982-0TB00		1	1 unit	42S
	Removable control terminals	• Screw terminals			▶	Screw terminals			
		3RW551.-.1H... (2x), 3RW552.-.1H... (2x), 3RW553.-.6H... (2x), 3RW554.-.6H... (2x), 3RW555.-.6H... (2x)	contains 2 blocks each with 6 terminals	▶	3RW5980-1TR00		1	1 unit	42S
		• Spring-loaded terminals			▶	Spring-loaded terminals			
3RW551.-.3H... (2x), 3RW552.-.3H... (2x), 3RW553.-.2H... (2x), 3RW554.-.2H... (2x), 3RW555.-.2H... (2x)	contains 2 blocks each with 6 terminals	▶	3RW5980-2TR00		1	1 unit	42S		
Terminal cover	3RW555	--	▶	3RW5955-0TC20		1	1 unit	42S	

Switching devices – Soft starters and solid-state switching devices

SIRIUS 3RW soft starters

Spare parts

For 3RW55/3RW55 Failsafe





Product designation	Manufacturer's Article No. of the soft starter	Type of product	SD	Article No.	Price per PU	PU (UNIT, SET, M)	PS*	PG	
Enclosure components									
	Enclosure base	3RW552..-HA..	--	▶	3RW5953-0GB00	1	1 unit	42S	
		3RW553..-HA..	--	▶	3RW5954-0GB00	1	1 unit	42S	
		3RW554..-HA..	--	▶	3RW5954-0GB00	1	1 unit	42S	
3RW5953-0GB00									
	Ventilation cover	3RW555 (3x)	--	▶	3RW5955-0GC00	1	1 unit	42S	
3RW5955-0GC00									
	Cover for control cable duct	3RW55..-HA..	Titanium gray	▶	3RW5950-0GD20	1	1 unit	42S	
		3RW55..-HF..	Yellow	▶	3RW5950-0GD30	1	1 unit	42S	
3RW5950-0GD20									
									
	3RW5950-0GD30								
	Front cover	3RW554..-HA..	--	▶	3RW5954-0GF00	1	1 unit	42S	
		3RW555	--	▶	3RW5955-0GF00	1	1 unit	42S	
3RW5954-0GF00									
	Hinged cover	3RW55	With cutout for High Feature HMI module	▶	3RW5950-0GL30	1	1 unit	42S	
3RW5950-0GL30									

Switching devices – Soft starters and solid-state switching devices

SIRIUS 3RW soft starters

Spare parts

For 3RW55/3RW55 Failsafe

Product designation	Manufacturer's Article No. of the soft starter	Type of product	SD	Article No.	Price per PU	PU (UNIT, SET, M)	PS*	PG
HMI modules								
	HMI module	3RW55	High Feature	▶ 3RW5980-0HF00		1	1 unit	42S
3RW5980-0HF00								
	Interface cover	3RW55	--	▶ 3RW5980-0HL00		1	1 unit	42S
3RW5980-0HL00								
Connecting cable for installing the HMI module in the soft starter								
	Connecting cable	--	0.1 m, flat	▶ 3UF7931-0AA00-0		1	1 unit	42J
3UF7931-0AA00-0								
Transport packaging								
	Transport packaging	3RW551	--	▶ 3RW5951-0VY00		1	1 unit	42S
		3RW552, 3RW553	--	▶ 3RW5953-0VY00		1	1 unit	42S
		3RW554	--	▶ 3RW5954-0VY00		1	1 unit	42S
		3RW555	--	▶ 3RW5955-0VY00		1	1 unit	42S
3RW5953-0VY00								

6

Switching devices – Soft starters and solid-state switching devices

SIRIUS 3RW soft starters

Spare parts

For 3RW52





Overview

More information

Homepage, see www.siemens.com/sirius-soft-starter
 Industry Mall, see www.siemens.com/product?3RW

Industry Online Support (SIOS) topic page, see
<https://support.industry.siemens.com/cs/ww/en/view/109747404>

Selection and ordering data

Product designation	Manufacturer's Article No. of the soft starter	Type of product	SD	Article No.	Price per PU	PU (UNIT, SET, M)	PS*	PG	
Power semiconductor modules									
 3RW5952-0SF04	Power semiconductor module	3RW5224-..C.4 (3x)	480 V, 47 A ▶	3RW5952-0SF04		1	1 unit	42S	
		3RW5225-..C.4 (3x), 3RW5226-..C.4 (3x)	480 V, 77 A ▶	3RW5952-0SH04		1	1 unit	42S	
		3RW5227-..C.4 (3x)	480 V, 93 A ▶	3RW5952-0SJ04		1	1 unit	42S	
		3RW5234-..C.4 (3x), 3RW5235-..C.4 (3x)	480 V, 143 A ▶	3RW5953-0SL04		1	1 unit	42S	
		3RW5236-..C.4 (3x)	480 V, 171 A ▶	3RW5953-0SM04		1	1 unit	42S	
		3RW5224-..C.5 (3x)	600 V, 47 A ▶	3RW5952-0SF05		1	1 unit	42S	
		3RW5225-..C.5 (3x), 3RW5226-..C.5 (3x)	600 V, 77 A ▶	3RW5952-0SH05		1	1 unit	42S	
		3RW5227-..C.5 (3x)	600 V, 93 A ▶	3RW5952-0SJ05		1	1 unit	42S	
		3RW5234-..C.5 (3x), 3RW5235-..C.5 (3x)	600 V, 143 A ▶	3RW5953-0SL05		1	1 unit	42S	
		3RW5236-..C.5 (3x)	600 V, 171 A ▶	3RW5953-0SM05		1	1 unit	42S	
 3RW5953-0SM05		3RW5243 (3x)	600 V, 210 A ▶	3RW5924-0SN05		1	1 unit	42S	
		3RW5244 (3x), 3RW5245 (3x)	600 V, 315 A ▶	3RW5924-0SQ05		1	1 unit	42S	
		3RW5246 (3x), 3RW5247 (3x)	600 V, 470 A ▶	3RW5924-0SS05		1	1 unit	42S	
		3RW5248 (3x)	600 V, 570 A ▶	3RW5924-0ST05		1	1 unit	42S	
 3RW5924-0ST05									
	Bypass units								
	 3RW5953-0BY00	Bypass unit	3RW522, 3RW523	-- ▶	3RW5953-0BY00		1	1 unit	42S
			3RW5243, 3RW5244, 3RW5245	210 ... 315 A ▶	3RW5954-0BP00		1	1 unit	42S
3RW5246, 3RW5247, 3RW5248			370 ... 570 A ▶	3RW5954-0BT00		1	1 unit	42S	
Control units									
 3RW5920-1UA00	Control unit	3RW52-..-AC0.	24 V analog output ▶	3RW5920-1UA00		1	1 unit	42S	
		3RW52-..-AC1.	110 ... 250 V analog output ▶	3RW5920-1UA10		1	1 unit	42S	
		3RW52-..-TC0.	24 V thermistor input ▶	3RW5920-1UT00		1	1 unit	42S	
		3RW52-..-TC1.	110 ... 250 V thermistor input ▶	3RW5920-1UT10		1	1 unit	42S	

Switching devices – Soft starters and solid-state switching devices

SIRIUS 3RW soft starters

Spare parts

For 3RW52



Product designation	Manufacturer's Article No. of the soft starter	Type of product	SD	Article No.	Price per PU	PU (UNIT, SET, M)	PS*	PG	
Printed circuit boards									
 3RW5923-0PY04  3RW5924-0PY05	Printed circuit board	3RW5213-..C.4	480 V, 13 A ▶	3RW5921-0PA04		1	1 unit	42S	
		3RW5214-..C.4	480 V, 18 A ▶	3RW5921-0PB04		1	1 unit	42S	
		3RW5215-..C.4	480 V, 25 A ▶	3RW5921-0PC04		1	1 unit	42S	
		3RW5216-..C.4	480 V, 32 A ▶	3RW5921-0PD04		1	1 unit	42S	
		3RW5217-..C.4	480 V, 38 A ▶	3RW5921-0PE04		1	1 unit	42S	
		3RW522-..C.4, 3RW523-..C.4	480 V ▶	3RW5923-0PY04		1	1 unit	42S	
		3RW524-..C.4	480 V ▶	3RW5924-0PY04		1	1 unit	42S	
		3RW5213-..C.5	600 V, 13 A ▶	3RW5921-0PA05		1	1 unit	42S	
		3RW5214-..C.5	600 V, 18 A ▶	3RW5921-0PB05		1	1 unit	42S	
		3RW5215-..C.5	600 V, 25 A ▶	3RW5921-0PC05		1	1 unit	42S	
		3RW5216-..C.5	600 V, 32 A ▶	3RW5921-0PD05		1	1 unit	42S	
		3RW5217-..C.5	600 V, 38 A ▶	3RW5921-0PE05		1	1 unit	42S	
		3RW522-..C.5, 3RW523-..C.5	600 V ▶	3RW5923-0PY05		1	1 unit	42S	
		3RW524-..C.5	600 V ▶	3RW5924-0PY05		1	1 unit	42S	
	Fans								
	 3RW5983-0FF00	Fans	3RW5216/17 (1x), 3RW5226/27 (2x), 3RW523 (2x)	-- ▶	3RW5983-0FF00		1	1 unit	42S
		3RW524 (1x)	-- ▶	3RW5984-0FF00		1	1 unit	42S	
Terminals									
 3RW5982-0TB00	Box terminal block	3RW522 (2x)	-- ▶	3RW5982-0TB00		1	1 unit	42S	
	 3RW5980-1TR00	Removable control terminals	• Screw terminals		Screw terminals				
		3RW521-..1.C.., 3RW522-..1.C.., 3RW523-..6.C.., 3RW524-..6.C..	contains 2 blocks each with 6 terminals	▶	3RW5980-1TR00		1	1 unit	42S
		• Spring-loaded terminals		Spring-loaded terminals					
		3RW521-..3.C.., 3RW522-..3.C.., 3RW523-..2.C.., 3RW524-..2.C..	contains 2 blocks each with 6 terminals	▶	3RW5980-2TR00		1	1 unit	42S
Enclosure components									
 3RW5953-0GB00	Enclosure base	3RW522, 3RW523	-- ▶	3RW5953-0GB00		1	1 unit	42S	
		3RW524	-- ▶	3RW5954-0GB00		1	1 unit	42S	
 3RW5950-0GD20	Cover for control cable duct	3RW52	Titanium gray ▶	3RW5950-0GD20		1	1 unit	42S	

Switching devices – Soft starters and solid-state switching devices

SIRIUS 3RW soft starters

Spare parts

For 3RW52

Product designation	Manufacturer's Article No. of the soft starter	Type of product	SD	Article No.	Price per PU	PU (UNIT, SET, M)	PS*	PG
Enclosure components								
	Front cover	3RW524	--	▶ 3RW5954-0GF00		1	1 unit	42S
3RW5954-0GF00								
	Hinged cover	3RW52	Without cutout	▶ 3RW5950-0GL20		1	1 unit	42S
3RW5950-0GL20								
Transport packaging								
	Transport packaging	3RW521	--	▶ 3RW5951-0VY00		1	1 unit	42S
		3RW522, 3RW523	--	▶ 3RW5953-0VY00		1	1 unit	42S
		3RW524	--	▶ 3RW5954-0VY00		1	1 unit	42S
3RW5953-0VY00								

Switching devices – Soft starters and solid-state switching devices

SIRIUS 3RW soft starters

Spare parts

For 3RW50





Overview

More information

Homepage, see www.siemens.com/sirius-soft-starter
 Industry Mall, see www.siemens.com/product?3RW

Industry Online Support (SIOS) topic page, see
<https://support.industry.siemens.com/cs/ww/en/view/109747404>

Selection and ordering data







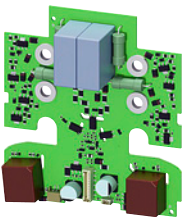

	Product designation	Manufacturer's Article No. of the soft starter	Type of product	SD	Article No.	Price per PU	PU (UNIT, SET, M)	PS*	PG
Power semiconductor modules									
 3RW5953-0SL0.	Power semiconductor module	3RW505-...B.4 (2x)	480 V, 171 A ▶		3RW5953-0SL04		1	1 unit	42S
		3RW505-...B.5 (2x)	600 V, 171 A ▶		3RW5953-0SL05		1	1 unit	42S
 3RW5924-0S.05		3RW5072 (2x)	600 V, 210 A ▶		3RW5924-0SN05		1	1 unit	42S
		3RW5073 (2x), 3RW5074 (2x)	600 V, 315 A ▶		3RW5924-0SQ05		1	1 unit	42S
		3RW5075 (2x), 3RW5076 (2x)	600 V, 470 A ▶		3RW5924-0SS05		1	1 unit	42S
		3RW5077 (2x)	600 V, 570 A ▶		3RW5924-0ST05		1	1 unit	42S
Bypass units									
 3RW5905-0BY00	Bypass unit	3RW505	-- ▶		3RW5905-0BY00		1	1 unit	42S
		3RW5072, 3RW5073, 3RW5074	210 ... 315 A ▶		3RW5907-0BQ00		1	1 unit	42S
		3RW5075, 3RW5076, 3RW5077	370 ... 570 A ▶		3RW5907-0BY00		1	1 unit	42S
Control units									
 3RW5905-1UA00	Control unit	Analog output							
		3RW505-..AB0.	24 V ▶		3RW5905-1UA00		1	1 unit	42S
		3RW505-..AB1.	110 ... 250 V ▶		3RW5905-1UA10		1	1 unit	42S
		3RW507-..AB0.	24 V ▶		3RW5907-1UA00		1	1 unit	42S
	3RW507-..AB1.	110 ... 250 V ▶		3RW5907-1UA10		1	1 unit	42S	
	Thermistor input								
	3RW505-..TB0.	24 V ▶		3RW5905-1UT00		1	1 unit	42S	
3RW505-..TB1.	110 ... 250 V ▶		3RW5905-1UT10		1	1 unit	42S		
3RW507-..TB0.	24 V ▶		3RW5907-1UT00		1	1 unit	42S		
3RW507-..TB1.	110 ... 250 V ▶		3RW5907-1UT10		1	1 unit	42S		

Switching devices – Soft starters and solid-state switching devices

SIRIUS 3RW soft starters

Spare parts

For 3RW50

Product designation	Manufacturer's Article No. of the soft starter	Type of product	SD	Article No.	Price per PU	PU (UNIT, SET, M)	PS*	PG	
Printed circuit boards									
	Printed circuit board	3RW505-...B.4	480 V	▶	3RW5905-0PY04		1	1 unit	42S
		3RW507-...B.4	480 V	▶	3RW5907-0PY04		1	1 unit	42S
		3RW505-...B.5	600 V	▶	3RW5905-0PY05		1	1 unit	42S
		3RW507-...B.5	600 V	▶	3RW5907-0PY05		1	1 unit	42S
Fan									
	Fan	3RW505 (1x)	--	▶	3RW5905-0FF00		1	1 unit	42S
		3RW507 (1x)	--	▶	3RW5907-0FF00		1	1 unit	42S
Terminals									
	Removable control terminals	• Screw terminals			Screw terminals				
		3RW50...-6.B..	contains 2 blocks each with 6 terminals	▶	3RW5980-1TR00		1	1 unit	42S
		• Spring-loaded terminals			Spring-loaded terminals				
		3RW50...-2.B..	contains 2 blocks each with 6 terminals	▶	3RW5980-2TR00		1	1 unit	42S
Enclosure components									
	Enclosure base	3RW505	--	▶	3RW5905-0GB00		1	1 unit	42S
		3RW507	--	▶	3RW5907-0GB00		1	1 unit	42S
Hinged cover									
	Hinged cover	3RW50	--	▶	3RW5900-0GL00		1	1 unit	42S
Transport packaging									
	Transport packaging	3RW505	--	▶	3RW5905-0VY00		1	1 unit	42S
		3RW507	--	▶	3RW5907-0VY00		1	1 unit	42S

Overview

More information

Industry Mall, see www.siemens.com/product?3RF

Online configurator, see www.siemens.com/sirius/configurators

SIRIUS 3RF solid-state switching devices



1-phase solid-state relay and 3-phase solid-state contactor

The SIRIUS 3RF2 solid-state switching devices reliably switch a wide range of different loads with alternating voltages in 50 and 60 Hz systems.

SIRIUS 3RF2 solid-state switching devices for resistive/inductive loads:

- Solid-state relays
- Solid-state contactors
- Function modules

SIRIUS 3RF2 – for almost unending activity

Conventional electromechanical switchgear is often overtaxed by the rise in the number of switching operations. A high switching frequency results in frequent failure and short replacement cycles. However, this does not have to be the case, because with the latest generation of our SIRIUS 3RF2 solid-state switching devices we provide you with solid-state relays and contactors with a particularly long endurance – for almost unending activity even under the toughest conditions and under high mechanical load, but also in noise-sensitive areas.

Proven time and again in service

SIRIUS 3RF2 solid-state switching devices have firmly established themselves in industrial applications. They are used above all in applications where loads are switched frequently – mainly with resistive load controllers, with the control of electrical heat or the control of valves and motors in conveyor systems. In addition to its use in areas with high switching frequencies, their silent switching means that SIRIUS is also ideally suited for use in noise-sensitive areas, such as offices or hospitals.

The most reliable solution for any application

Compared to mechanical switchgear, our SIRIUS 3RF2 solid-state switching devices stand out due to their considerably longer service life. Thanks to the high product quality, their switching is extremely precise, reliable and, above all, unsusceptible to faults. With its variable connection methods and a wide spread of control voltages, the SIRIUS 3RF2 family is universally applicable. Depending on the individual requirements of the application, our modular switchgear can also be quite easily expanded by the addition of standardized function modules.

Always on the sunny side with SIRIUS

Because SIRIUS 3RF2 offers even more:

- The space-saving and compact side-by-side mounting ensures reliable operation up to an ambient temperature of +60 °C.
- Thanks to fast configuration and the ease of mounting and startup, not only time but also expenses are saved.

Also for switching motors (see page 6/157)



In order to achieve higher productivity, the switching frequency is continuously increased. It is no problem for our SIRIUS solid-state contactors for switching motors. With three-phase motor up to 7.5 kW, they can reliably withstand even the highest switching frequencies. Even a continuous change in the direction of rotation is possible with the solid-state reversing contactors. Both versions can be perfectly combined with components from the SIRIUS modular system. Connecting with SIRIUS motor starter protectors or SIRIUS overload relays can be implemented without any further steps.

SIRIUS 3RF3 solid-state switching devices for switching motors:

- Solid-state contactors
- Solid-state reversing contactors

Connection methods

The solid-state switching devices are available with screw terminals (box terminals), spring-loaded terminals or ring terminal lugs.

-  Screw terminals
-  Spring-loaded terminals
-  Ring terminal lug connection

The connection method is indicated in the corresponding tables by the respective symbol shown on an orange background.

Switching devices – Soft starters and solid-state switching devices

Solid-state switching devices for resistive/inductive loads

General data

Online configurator

- Simple selection of individual solid-state switching devices by means of technical characteristics (e.g. zero-point switching, spring-loaded terminals and rated current)
- Once configuration is complete, you receive the article numbers corresponding to the products.

See

www.siemens.com/sirius/configurators

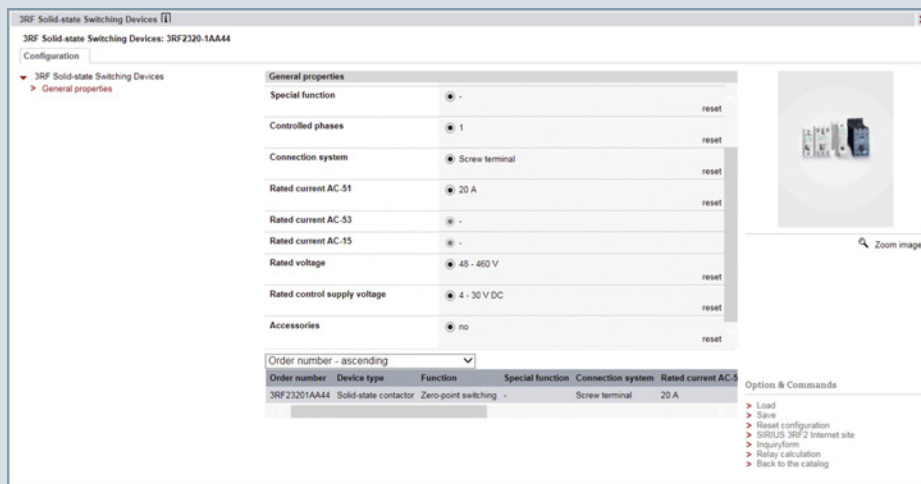

Online configurator for 3RF solid-state switching devices

Article No. scheme

Product versions		Article number	
Device type	Solid-state relays	3RF20	<input type="checkbox"/> <input type="checkbox"/> - <input type="checkbox"/> <input type="checkbox"/> <input type="checkbox"/> <input type="checkbox"/> <input type="checkbox"/> 1-phase, 45-mm width
		3RF21	<input type="checkbox"/> <input type="checkbox"/> - <input type="checkbox"/> <input type="checkbox"/> <input type="checkbox"/> <input type="checkbox"/> <input type="checkbox"/> 1-phase, 22.5-mm width
		3RF22	<input type="checkbox"/> <input type="checkbox"/> - <input type="checkbox"/> <input type="checkbox"/> <input type="checkbox"/> <input type="checkbox"/> <input type="checkbox"/> 3-phase, 45-mm width
	Solid-state contactors	3RF23	<input type="checkbox"/> <input type="checkbox"/> - <input type="checkbox"/> <input type="checkbox"/> <input type="checkbox"/> <input type="checkbox"/> <input type="checkbox"/> 1-phase
		3RF24	<input type="checkbox"/> <input type="checkbox"/> - <input type="checkbox"/> <input type="checkbox"/> <input type="checkbox"/> <input type="checkbox"/> <input type="checkbox"/> 3-phase
Type current	e.g. 20 = 20 A	<input type="checkbox"/> <input type="checkbox"/>	
Connection type	Screw terminals	1	
	Spring-loaded terminals	2	
	Ring terminal lug connection	3	
Switching function	Zero-point switching	A	
	Instantaneous switching	B	
	Zero-point switching	C	Low Noise
	Zero-point switching	D	Short-circuit-proof with B-type MCB
1-phase or number of controlled phases	1-phase	A	
	2-phase	B	
	3-phase	C	
	Reversing contactor	D	
	Rated control supply voltage U_s	24 V DC	0
24 V AC/DC		1	
110 ... 230 V AC		2	
110 V AC		3	
4 ... 30 V DC		4	
Rated operational voltage U_e	230 V AC	5	
	24 ... 230 V AC	2	
	48 ... 460 V AC	4	
	48 ... 600 V AC	5	
	48 ... 600 V AC	6	Blocking voltage 1 600 V
Example		3RF21 2 0 - 1 A A 0 6	

Note:

The Article No. scheme shows an overview of product versions for better understanding of the logic behind the article numbers.

For your orders please use the article numbers quoted in the selection and ordering data.

Switching devices – Soft starters and solid-state switching devices

Solid-state switching devices for resistive/inductive loads

General data

Overview of the SIRIUS 3RF2 solid-state switching devices

Type	Solid-state relays			Solid-state contactors		Function modules					
	1-phase 22.5 mm	45 mm	3-phase 45 mm	1-phase	3-phase	Converters	Load monitoring Basic	Extended	Heating current monitoring	Power controllers	Power regulators
Usage											
Simple replacement of existing solid-state relays	<input type="checkbox"/>	<input checked="" type="checkbox"/>	<input type="checkbox"/>	<input type="checkbox"/>	<input type="checkbox"/>	--	--	--	--	--	--
Complete unit "Ready to use"	<input type="checkbox"/>	<input type="checkbox"/>	<input type="checkbox"/>	<input checked="" type="checkbox"/>	<input checked="" type="checkbox"/>	--	--	--	--	--	--
Space-saving	<input checked="" type="checkbox"/>	--	<input checked="" type="checkbox"/>	<input checked="" type="checkbox"/>	<input checked="" type="checkbox"/>	<input checked="" type="checkbox"/>	<input checked="" type="checkbox"/>	--	--	--	--
Can be extended with modular function modules	<input checked="" type="checkbox"/>	--	1)	<input checked="" type="checkbox"/>	1)	--	--	--	--	--	--
Frequent switching and monitoring of the load and the solid-state relay or contactor	--	--	--	--	--	--	<input checked="" type="checkbox"/>	<input checked="" type="checkbox"/>	<input checked="" type="checkbox"/>	<input checked="" type="checkbox"/>	<input checked="" type="checkbox"/>
Monitoring of up to 6 partial loads	--	--	--	--	--	--	<input checked="" type="checkbox"/>	--	<input checked="" type="checkbox"/>	<input checked="" type="checkbox"/>	--
Monitoring of more than 6 partial loads	--	--	--	--	--	--	--	<input checked="" type="checkbox"/>	--	--	--
Control of the heating power through an analog input	--	--	--	--	--	<input checked="" type="checkbox"/>	--	--	--	<input checked="" type="checkbox"/>	<input checked="" type="checkbox"/>
Power control	--	--	--	--	--	--	--	--	--	--	<input checked="" type="checkbox"/>
Startup											
Easy setting of setpoint values with "Teach" button	--	--	--	--	--	--	<input checked="" type="checkbox"/>	<input checked="" type="checkbox"/>	--	<input checked="" type="checkbox"/>	<input checked="" type="checkbox"/>
"Remote Teach" input for setting setpoints	--	--	--	--	--	--	--	--	<input checked="" type="checkbox"/>	--	--
Mounting											
Mounting onto mounting rails or mounting plates	--	--	--	<input checked="" type="checkbox"/>	<input checked="" type="checkbox"/>	--	--	--	--	--	--
Can be snapped directly onto a solid-state relay or contactor	--	--	--	--	--	<input checked="" type="checkbox"/>	<input checked="" type="checkbox"/>	<input checked="" type="checkbox"/>	<input checked="" type="checkbox"/>	<input checked="" type="checkbox"/>	<input checked="" type="checkbox"/>
For use with "Coolplate" heat sink	<input checked="" type="checkbox"/>	<input checked="" type="checkbox"/>	<input checked="" type="checkbox"/>	--	--	--	--	--	--	--	--
Cable routing											
Connection of load circuit as for switchgear	<input checked="" type="checkbox"/>	--	<input checked="" type="checkbox"/>	<input checked="" type="checkbox"/>	<input checked="" type="checkbox"/>	--	<input checked="" type="checkbox"/>	<input checked="" type="checkbox"/>	<input checked="" type="checkbox"/>	<input checked="" type="checkbox"/>	<input checked="" type="checkbox"/>
Connection of load circuit from above	--	<input checked="" type="checkbox"/>	--	--	--	--	--	--	--	--	--

✓ Function available

☐ Function possible

-- Function not possible

1) The converter can also be used with 3-phase devices.

Switching devices – Soft starters and solid-state switching devices

Solid-state switching devices for resistive/inductive loads

General data

Benefits

Features

- Considerable space savings thanks to a width of only 22.5 mm
- Variety of connection methods: Screw terminal, spring-loaded terminal or ring terminal lug, there is no problem – they are all finger-safe
- Flexible for all applications with function modules for retrofitting
- Possibility of fuseless short-circuit proof design

Benefits

- Saves time and costs with fast mounting and commissioning, short startup times and easy wiring

- Extremely long life, low maintenance, rugged and reliable
- Space-saving and safe thanks to side-by-side mounting up to an ambient temperature of +60 °C
- Modular design: Standardized function modules and heat sinks can be used in conjunction with solid-state relays to satisfy individual requirements.
- Safety due to lifelong, vibration-resistant and shock-resistant spring-loaded terminal connection method even under tough conditions
- Optimum heat transfer allows small, space-saving heat sinks to be used

Application

Applications

Example: Plastics processing industry

Thanks to their high switching endurance SIRIUS 3RF2 solid-state switching devices are ideal for controlling electrical heat. This is because the more precise the temperature regulation process has to be, the higher the switching frequency. The accurate regulation of electrical heat is used for example in many processes in the plastics processing industry:

- Band heaters heat the extrudate to the correct temperature in plastic extruders
- Heat emitters heat plastic blanks to the correct temperature
- Heat drums dry plastic granules
- Heating channels keep molds at the correct temperature in order to manufacture different plastic parts without defects

The powerful SIRIUS 3RF2 solid-state relays and contactors can be used for the simultaneous control of several heating loads. By using a load monitoring module the individual partial loads can easily be monitored, and in the event of a failure a signal is generated to be sent to the controller.

Use in fuseless load feeders

Compared with the fused configuration of load feeders, short circuit and line protection using miniature circuit breakers is easy to achieve with SIRIUS 3RF2 solid-state relays and contactors.

A special version of the solid-state contactors can be protected against damage in the case of a short circuit with a miniature circuit breaker with type B tripping characteristic. This allows the low-cost and simple design of fuseless load feeders with full protection of the switchgear.

More information

Notes on integration in the load feeders

The SIRIUS solid-state switching devices are very easy to integrate into the load feeders thanks to their industrial connection method and design.

Particular attention must however be paid to the circumstances of the installation and ambient conditions, as the performance of the solid-state switching devices is largely dependent on these. Depending on the version, certain restrictions must be observed. For detailed information, for example in relation to solid-state contactors about the minimum spacing and to solid-state relays about the choice of heat sink, see [technical specifications and product data sheets, https://support.industry.siemens.com/cs/ww/en/ps/16222](https://support.industry.siemens.com/cs/ww/en/ps/16222).

Short-circuit and overload protection

Despite the rugged power semiconductors that are used, solid-state switching devices respond more sensitively to short circuits in the load feeder. Consequently, special precautions have to be taken against destruction, depending on the type of design.

Siemens generally recommends using SITOP semiconductor protection fuses. These fuses also provide protection against destruction in the event of a short circuit even when the solid-state contactors and solid-state relays are fully utilized.

Alternatively, if there is lower loading, protection can also be provided by standard fuses or miniature circuit breakers. This protection is achieved by overdimensioning the solid-state switching devices accordingly. The technical specifications and the product data sheets contain details both about the solid-state fuse protection itself and about use of the devices with conventional protection equipment.

Electromagnetic compatibility (EMC)

The solid-state switching devices are suitable for interference-free operation in industrial networks without further measures. If they are used in public networks, it may be necessary for conducted interference to be reduced by means of filters.

This does not include the solid-state contactors for resistive loads of the special type 3RF23.-.CA.. "Low Noise". These comply with the class B limit values up to a rated current of 16 A. If other versions are used, and at currents of over 16 A, standard filters can be used in order to comply with the limit values. The decisive factors when it comes to selecting the filters are essentially the current loading and the other parameters (operational voltage, design type, etc.) in the load feeder.

Suitable filters can be ordered from EPCOS AG, see [page 16/16](#).

Product information and technical specifications

For product data sheets with detailed technical specifications, dimensional drawings and characteristic curves, see <https://support.industry.siemens.com/cs/ww/en/ps/16222>.

For additional information, please enter the article number of the required device under the tab "Product List".

Overview

Solid-state relays (without heat sink)

SIRIUS solid-state relays are suitable for surface mounting on existing cooling surfaces. Mounting is quick and easy, involving just two screws. The special technology of the power semiconductor ensures there is excellent thermal contact with the heat sink. Depending on the nature of the heat sink, the capacity reaches up to 88 A on resistive loads.

The solid-state relays are available in three different versions:

- 3RF21 1-phase solid-state relays with a width of 22.5 mm
- 3RF20 1-phase solid-state relays with a width of 45 mm
- 3RF22 3-phase solid-state relays with a width of 45 mm

Version for resistive loads "zero-point switching"

This standard version is often used for 3RF20 to 3RF22 solid-state relays for switching heaters on and off.

Version for inductive loads "instantaneous switching"

In this version, the 3RF20 and 3RF21 solid-state relays are specifically matched to inductive loads. Whether it is a matter of frequent actuation of the valves in a filling plant or starting and stopping small operating mechanisms in packet distribution systems, operation is carried out safely and noiselessly.

Special "low noise" version

Thanks to a special control circuit of the 3RF21 solid-state contactors, this special version can be used in public networks up to 16 A without any additional measures such as interference suppressor filters. As a result, in terms of emitted interference, it conforms to limit value curve class B according to IEC 60947-4-3.

Function modules

The 3RF21 and 3RF22 solid-state relays can be expanded with various function modules for individual adaptation to applications, [see page 6/148 onwards](#).

3RF21 1-phase solid-state relays with a width of 22.5 mm

With its compact design and a width of just 22.5 mm, which stays the same even at currents of up to 88 A, the 3RF21 solid-state relay offers an ultra small footprint. The logical connection method, with the power infeed from above and load connection from below, ensures tidy installation in the control cabinet.

3RF20 1-phase solid-state relays with a width of 45 mm

The solid-state relays with a width of 45 mm provide for connection of the power supply lead and the load from above. This makes it easy to replace existing solid-state relays in existing arrangements. The connection of the control cable is as space-saving as the 22.5 mm design, as it is simply plugged on.

3RF22 3-phase solid-state relays with a width of 45 mm

With its compact design and a width of just 45 mm, which stays the same even at currents of up to 55 A, the 3RF22 solid-state relay offers an ultra small footprint. The logical connection method, with the power infeed from above and load connection from below, ensures tidy installation in the control cabinet.

The 3-phase solid-state relays are available with

- 2-phase control (suitable in particular for circuits without connection to the neutral conductor) and
- 3-phase control (suitable for star circuits with connection to the neutral conductor or for applications in which the system requires all phases to be switched)

Selection notes

When selecting solid-state relays, in addition to information about the network, the load and the ambient conditions it is also necessary to know details of the planned design. The solid-state relays can only conform to their specific technical specifications if they are mounted with appropriate care on an adequately dimensioned heat sink.

Mounting solid-state relays directly on a mounting plate made of sheet steel is inadequate in terms of heat dissipation.

The following procedure is recommended:

- Determine the rated current of the load and the mains voltage
- Select the relay design and choose a solid-state relay with higher rated current than the load
- Determine the thermal resistance of the proposed heat sink
- Check the correct relay size with the aid of the diagrams
- In systems that have high voltage peaks or at voltages of 575 V and higher, use of versions with a blocking voltage of 1 600 V is recommended.

Switching devices – Soft starters and solid-state switching devices

Solid-state switching devices for resistive/inductive loads

Solid-state relays

SIRIUS 3RF21 solid-state relays, 1-phase, 22.5 mm





Overview

1-phase solid-state relays (without heat sink) with a width of 22.5 mm

With its compact design and a width of just 22.5 mm, which stays the same even at currents of up to 88 A, the 3RF21 solid-state relay offers an ultra small footprint. The logical

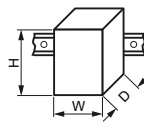
connection method, with the power infeed from above and load connection from below, ensures tidy installation in the control cabinet.

Technical specifications

More information				
System Manual for modular system, see https://support.industry.siemens.com/cs/ww/en/view/60311318		FAQs, see https://support.industry.siemens.com/cs/ww/en/ps/16223/faq		
Type		3RF21..-1....	3RF21..-2....	3RF21..-3....
Dimensions (W x H x D)	 mm	22.5 x 85 x 48 mm	22.5 x 85 x 48 mm	22.5 x 85 x 48 mm
General data				
Ambient temperature				
• During operation, derating from 40 °C	°C	-25 ... +60		
• During storage	°C	-55 ... +80		
Installation altitude				
	m	0 ... 1 000; derating from 1000		
Shock resistance acc. to IEC 60068-2-27				
	g/ms	15/11		
Vibration resistance acc. to IEC 60068-2-6				
	g	2		
Degree of protection IP on the front acc. to IEC 60529				
		IP20		IP00 (IP20 when using the 3RF2900-3PA88 terminal cover)
Touch protection on the front acc. to IEC 60529				
		Finger-safe for vertical touching from the front		--
Electromagnetic compatibility (EMC)				
• Emitted interference				
- Conducted interference voltage acc. to IEC 60947-4-3		Class A for industrial applications		
- Emitted, high-frequency interference voltage acc. to IEC 60947-4-3		Class B for residential, business and commercial applications		
• Interference immunity				
- Electrostatic discharge acc. to IEC 61000-4-2 (corresponds to degree of severity 3)	kV	Contact discharge 4; air discharge 8; behavior criterion 2		
- Induced RF fields acc. to IEC 61000-4-6	MHz	0.15 ... 80; 140 dBµV; behavior criterion 1		
- Burst acc. to IEC 61000-4-4	kV	2/5.0 kHz; behavior criterion 2		
- Surge acc. to IEC 61000-4-5	kV	Conductor - ground 2; conductor - conductor 1; behavior criterion 2		
Mounting				
• Screws (not included in the scope of supply)		2 x M4		
• Tightening torque	Nm	1.5		
Connection type		 Screw terminals	 Spring-loaded terminals	 Ring terminal lug connection
Connection, main contacts				
• Conductor cross-sections				
- Solid	mm ²	2 x (1.5 ... 2.5) ¹⁾ , 2 x (2.5 ... 6) ¹⁾		2 x (0.5 ... 2.5)
- Finely stranded with end sleeve	mm ²	2 x (1 ... 2.5) ¹⁾ , 2 x (2.5 ... 6) ¹⁾ , 1 x 10		2 x (0.5 ... 1.5)
- Finely stranded without end sleeve	mm ²	--		2 x (0.5 ... 2.5)
- Solid or stranded, AWG cables	AWG	2 x (14 ... 10)		2 x (18 ... 14)
• Terminal screws				
		M4		M5
• Tightening torque				
	Nm	2 ... 2.5		2 ... 2.5
	lb.in	7 ... 10.3		7 ... 10.3
• Cable lugs				
- According to DIN 46234		--		5-2.5, 5-6, 5-10, 5-16, 5-25
- According to JIS C 2805		--		R 2-5, R 5.5-5, R 8-5, R 14-5
- Width, maximum	mm	--		12
Connection, auxiliary/control contacts				
• Conductor cross-sections				
	mm	1 x (0.5 ... 2.5), 2 x (0.5 ... 1.0)		1 x (0.5 ... 2.5), 2 x (0.5 ... 1.0)
	AWG	20 ... 12		20 ... 12
• Stripped length				
	mm	7		7
• Terminal screw				
		M3		M3
• Tightening torque				
	Nm	0.5 ... 0.6		0.5 ... 0.6
	lb.in	4.5 ... 5.3		4.5 ... 5.3

¹⁾ If two different conductor cross-sections are connected to one clamping point, both cross-sections must lie in one of the ranges specified.

Switching devices – Soft starters and solid-state switching devices

Solid-state switching devices for resistive/inductive loads

Solid-state relays

SIRIUS 3RF21 solid-state relays, 1-phase, 22.5 mm

The heat transfer of the solid-state relays has been considerably improved. Please note the **highlighted values** when dimensioning the heat sink.

Type	$I_{\max}^{1)}$ at $R_{\text{thha}}/T_u = 40\text{ °C}$		I_e acc. to IEC 60947-4-3 at $R_{\text{thha}}/T_u = 40\text{ °C}$		I_e acc. to UL/CSA at $R_{\text{thha}}/T_u = 50\text{ °C}$		Power loss at I_{\max}	Minimum load current	Off-state current
	A	K/W	A	K/W	A	K/W	W	A	mA
Main circuit									
3RF2120-.....	20	2.00	20	1.70	20	1.30	28.6	0.1	10
3RF2130-1....	30	1.45	30	1.45	30	1.25	44.2	0.5	10
3RF2150-1....	50	0.85	50	0.85	50	0.70	66	0.5	10
3RF2150-2....	50	0.85	20	2.90	20	2.60	66	0.5	10
3RF2150-3....	50	0.85	50	0.85	50	0.70	66	0.5	10
3RF2170-1....	70	0.50	50	1.15	50	1.00	94	0.5	10
3RF2190-1....	88	0.55	50	1.40	50	0.85	118	0.5	10
3RF2190-2....	88	0.55	20	3.50	20	2.80	118	0.5	10
3RF2190-3....	88	0.55	80	0.55	80	0.45	118	0.5	10

¹⁾ The current I_{\max} provides information about the performance of the solid-state relay. The actual permitted rated operational current I_e can be smaller depending on the connection method and cooling conditions.

Note:

The required heat sinks for the corresponding load currents can be determined from the characteristic curves (see page 6/118, "More information"). The minimum thickness values for the mounting surface must be observed.

Type	Rated peak withstand current I_{ISM}		I^2t value
	A		A ² s
Main circuit			
3RF2120-.....	200		200
3RF2130-...A.2	300		450
3RF2130-...A.4	300		450
3RF2130-...A.5	300		450
3RF2130-...A.6	400		800
3RF2150-.....	600		1 800
3RF2170-...A.2	1 200		7 200
3RF2170-...A.4	1 200		7 200
3RF2170-...A.5	1 200		7 200
3RF2170-...A.6	1 150		6 600
3RF2190-.....	1 150		6 600

Type		3RF21...-...2	3RF21...-...4	3RF21...-...5	3RF21...-...6
Main circuit					
Rated operational voltage U_e	V AC	24 ... 230	48 ... 460	48 ... 600	
• Operating range	V AC	20 ... 253	40 ... 506	40 ... 660	
• Rated frequency	Hz	50/60 ± 10%			
Rated insulation voltage U_i	V	600			
Blocking voltage	V	800	1 200		1 600
Rate of voltage rise	V/μs	1 000			

Type		3RF21...-...0.	3RF21...-...1.	3RF21...-...2.	3RF21...-...4.
Control circuit					
Method of operation		DC operation	AC/DC operation	AC operation	DC operation
Rated control supply voltage U_s	V	24	24 AC 24 DC	1105 ... 230	4 ... 30
Rated frequency of the control supply voltage	Hz	--	50/60 ± 10%	--	50/60 ± 10%
Control supply voltage, max.	V	30	26.5 AC 30 DC	253	30
Typical actuating current	mA	15 / Low Power: ⁹⁾	20	15	15
Response voltage	V	15	14 AC 15 DC	90	4
Drop-out voltage	V	5	5 AC 5 DC	40	1
Operating times					
• ON-delay	ms	1 + max. one half-wave ²⁾	10 + max. one half-wave ²⁾	40 + max. one half-wave ²⁾	1 + max. one half-wave ²⁾
• OFF-delay	ms	1 + max. one half-wave	15 + max. one half-wave	40 + max. one half-wave	1 + max. one half-wave

¹⁾ Applies to the "Low Power" version 3RF21...-AA...-0KNO.

²⁾ Only for zero-point switching devices.

Switching devices – Soft starters and solid-state switching devices

Solid-state switching devices for resistive/inductive loads

Solid-state relays

SIRIUS 3RF21 solid-state relays, 1-phase, 22.5 mm

Selection and ordering data

1-phase solid-state relays (without heat sink) with a width of 22.5 mm

Type current/ performance capacity ¹⁾	Rated control supply voltage U_s	SD	Screw terminals	⊕	PU (UNIT, SET, M)	PS*	PG
A	V	d					
Zero-point switching, rated operational voltage U_e 24 ... 230 V AC							
	20	24 DC	2	3RF2120-1AA02		1	1 unit 41C
	30		2	3RF2130-1AA02		1	1 unit 41C
	50		2	3RF2150-1AA02		1	1 unit 41C
	70 ²⁾		2	3RF2170-1AA02		1	1 unit 41C
	90 ²⁾		5	3RF2190-1AA02		1	1 unit 41C
	20	110 ... 230 AC	2	3RF2120-1AA22		1	1 unit 41C
	30		2	3RF2130-1AA22		1	1 unit 41C
	50		5	3RF2150-1AA22		1	1 unit 41C
	70 ²⁾		5	3RF2170-1AA22		1	1 unit 41C
	90 ²⁾		5	3RF2190-1AA22		1	1 unit 41C
3RF2120-1AA02	20	4 ... 30 DC	2	3RF2120-1AA42		1	1 unit 41C
	30		2	3RF2130-1AA42		1	1 unit 41C
Zero-point switching, rated operational voltage U_e 48 ... 460 V AC							
20	24 DC	2	3RF2120-1AA04		1	1 unit 41C	
30		2	3RF2130-1AA04		1	1 unit 41C	
50		2	3RF2150-1AA04		1	1 unit 41C	
70 ²⁾		2	3RF2170-1AA04		1	1 unit 41C	
90 ²⁾		2	3RF2190-1AA04		1	1 unit 41C	
20	24 AC/DC	5	3RF2150-1AA14		1	1 unit 41C	
20	110 ... 230 AC	2	3RF2120-1AA24		1	1 unit 41C	
30		2	3RF2130-1AA24		1	1 unit 41C	
50		5	3RF2150-1AA24		1	1 unit 41C	
70 ²⁾		2	3RF2170-1AA24		1	1 unit 41C	
90 ²⁾		5	3RF2190-1AA24		1	1 unit 41C	
Zero-point switching, rated operational voltage U_e 48 ... 600 V AC							
70	24 DC Low Power	5	3RF2170-1AA05-0KNO		1	1 unit 41C	
20	4 ... 30 DC	5	3RF2120-1AA45		1	1 unit 41C	
30		5	3RF2130-1AA45		1	1 unit 41C	
50		5	3RF2150-1AA45		1	1 unit 41C	
70 ²⁾		2	3RF2170-1AA45		1	1 unit 41C	
90 ²⁾		5	3RF2190-1AA45		1	1 unit 41C	
Zero-point switching · Blocking voltage 1 600 V, rated operational voltage U_e 48 ... 600 V AC							
30	24 DC	2	3RF2130-1AA06		1	1 unit 41C	
50		2	3RF2150-1AA06		1	1 unit 41C	
70 ²⁾		5	3RF2170-1AA06		1	1 unit 41C	
90 ²⁾		5	3RF2190-1AA06		1	1 unit 41C	
30	110 ... 230 AC	5	3RF2130-1AA26		1	1 unit 41C	
50		5	3RF2150-1AA26		1	1 unit 41C	
70 ²⁾		5	3RF2170-1AA26		1	1 unit 41C	
90 ²⁾		5	3RF2190-1AA26		1	1 unit 41C	

¹⁾ The type current provides information about the performance capacity of the solid-state relay. The actual permitted rated operational current I_e can be smaller depending on the connection method and cooling conditions.

²⁾ Please note that this version with an M4 screw connection can only be used for a rated current of up to approx. 50 A and a conductor cross-section of 10 mm². Please use the 3RF21 solid-state relays with ring terminal lugs for these currents, see page 6/124.

Other rated control supply voltages on request.

For accessories, see page 6/125.

Switching devices – Soft starters and solid-state switching devices

Solid-state switching devices for resistive/inductive loads

Solid-state relays

SIRIUS 3RF21 solid-state relays, 1-phase, 22.5 mm

Type current/ performance capacity ¹⁾	Rated control supply voltage U_s	SD	Screw terminals 	PU (UNIT, SET, M)	PS*	PG
A	V	d	Article No.	Price per PU		
Instantaneous switching, rated operational voltage U_e 24 ... 230 V AC						
50	110 ... 230 AC	5	3RF2150-1BA22		1	1 unit 41C
Instantaneous switching, rated operational voltage U_e 48 ... 460 V AC						
20	24 DC	5	3RF2120-1BA04		1	1 unit 41C
30		5	3RF2130-1BA04		1	1 unit 41C
50		5	3RF2150-1BA04		1	1 unit 41C
70 ²⁾		5	3RF2170-1BA04		1	1 unit 41C
90 ²⁾		5	3RF2190-1BA04		1	1 unit 41C
Instantaneous switching · Blocking voltage 1 600 V, rated operational voltage U_e 48 ... 600 V AC						
50	24 DC	5	3RF2150-1BA06		1	1 unit 41C
Low noise³⁾ · Zero-point switching, rated operational voltage U_e 48 ... 460 V AC						
70 ²⁾	24 DC	5	3RF2170-1CA04		1	1 unit 41C

1) The type current provides information about the performance capacity of the solid-state relay. The actual permitted rated operational current I_e can be smaller depending on the connection method and cooling conditions.

2) Please note that this version with an M4 screw connection can only be used for a rated current of up to approx. 50 A and a conductor cross-section of 10 mm². Please use the 3RF21 solid-state relays with ring terminal lugs for these currents, see page 6/124.

3) See page 6/119.

Other rated control supply voltages on request.

For accessories, see page 6/125.

Type current/ performance capacity ¹⁾	Rated control supply voltage U_s	SD	Spring-loaded terminals 	PU (UNIT, SET, M)	PS*	PG
A	V	d	Article No.	Price per PU		
Zero-point switching, rated operational voltage U_e 24 ... 230 V AC						
20	24 DC	2	3RF2120-2AA02		1	1 unit 41C
50 ²⁾		5	3RF2150-2AA02		1	1 unit 41C
90 ²⁾		5	3RF2190-2AA02		1	1 unit 41C
20	110 ... 230 AC	5	3RF2120-2AA22		1	1 unit 41C
50 ²⁾		5	3RF2150-2AA22		1	1 unit 41C
90 ²⁾		5	3RF2190-2AA22		1	1 unit 41C
20	4 ... 30 DC	5	3RF2120-2AA42		1	1 unit 41C
Zero-point switching, rated operational voltage U_e 48 ... 460 V AC						
20	24 DC	2	3RF2120-2AA04		1	1 unit 41C
50 ²⁾		5	3RF2150-2AA04		1	1 unit 41C
90 ²⁾		5	3RF2190-2AA04		1	1 unit 41C
50 ²⁾	24 AC/DC	5	3RF2150-2AA14		1	1 unit 41C
20	110 ... 230 AC	5	3RF2120-2AA24		1	1 unit 41C
50 ²⁾		5	3RF2150-2AA24		1	1 unit 41C
90 ²⁾		5	3RF2190-2AA24		1	1 unit 41C
Zero-point switching, rated operational voltage U_e 48 ... 600 V AC						
20	4 ... 30 DC	5	3RF2120-2AA45		1	1 unit 41C
Zero-point switching · Blocking voltage 1 600 V, rated operational voltage U_e 48 ... 600 V AC						
50 ²⁾	24 DC	5	3RF2150-2AA06		1	1 unit 41C
90 ²⁾		5	3RF2190-2AA06		1	1 unit 41C
50 ²⁾	110 ... 230 AC	5	3RF2150-2AA26		1	1 unit 41C
90 ²⁾		5	3RF2190-2AA26		1	1 unit 41C



3RF2120-2AA02

1) The type current provides information about the performance capacity of the solid-state relay. The actual permitted rated operational current I_e can be smaller depending on the connection method and cooling conditions.

2) Please note that the version with spring-loaded terminals can only be used for a rated current of up to approx. 20 A and a conductor cross-section of 2.5 mm². Higher currents can be achieved by connecting two conductors per terminal.

Other rated control supply voltages on request.

For accessories, see page 6/125.

Switching devices – Soft starters and solid-state switching devices

Solid-state switching devices for resistive/inductive loads

Solid-state relays

SIRIUS 3RF21 solid-state relays, 1-phase, 22.5 mm

Type current/ performance capacity ¹⁾	Rated control supply voltage U_s	SD	Ring terminal lug connection	PU (UNIT, SET, M)	PS*	PG
A	V	d	Article No.	Price per PU		
Zero-point switching, rated operational voltage U_e 24 ... 230 V AC						
	20	24 DC	5	3RF2120-3AA02	1	1 unit 41C
	50		5	3RF2150-3AA02	1	1 unit 41C
	90		5	3RF2190-3AA02	1	1 unit 41C
	20	110 ... 230 AC	5	3RF2120-3AA22	1	1 unit 41C
	50		5	3RF2150-3AA22	1	1 unit 41C
	90		5	3RF2190-3AA22	1	1 unit 41C
Zero-point switching, rated operational voltage U_e 48 ... 460 V AC						
	20	24 DC	5	3RF2120-3AA04	1	1 unit 41C
	50		5	3RF2150-3AA04	1	1 unit 41C
	90		5	3RF2190-3AA04	1	1 unit 41C
	20	110 ... 230 AC	5	3RF2120-3AA24	1	1 unit 41C
	50		5	3RF2150-3AA24	1	1 unit 41C
	90		5	3RF2190-3AA24	1	1 unit 41C
	90	4 ... 30 DC	5	3RF2190-3AA44	1	1 unit 41C
Zero-point switching · Blocking voltage 1 600 V, rated operational voltage U_e 48 ... 600 V AC						
	50	24 DC	5	3RF2150-3AA06	1	1 unit 41C
	90		5	3RF2190-3AA06	1	1 unit 41C
	50	110 ... 230 AC	5	3RF2150-3AA26	1	1 unit 41C
	90		5	3RF2190-3AA26	1	1 unit 41C

¹⁾ The type current provides information about the performance capacity of the solid-state relay. The actual permitted rated operational current I_e can be smaller depending on the connection method and cooling conditions.

Other rated control supply voltages on request.

For accessories, see page 6/125.





Switching devices – Soft starters and solid-state switching devices

Solid-state switching devices for resistive/inductive loads

Solid-state relays

SIRIUS 3RF21 solid-state relays, 1-phase, 22.5 mm

Accessories

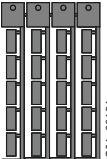
Version	SD	Article No.	Price per PU	PU (UNIT, SET, M)	PS*	PG
Terminal covers						
		Ring terminal lug connection 3RF2900-3PA88		1	10 units	41C
Terminal covers For 3RF21 solid-state relays with ring terminal lug connection With this terminal cover, degree of protection IP20 can be achieved on the front with a ring terminal lug connection. It can also be used for screw terminals after simple adaptation.		15				
Control connectors						
		Screw terminals 3RF2900-1TA88		1	50 units	41C
Replacement control connectors For 3RF20 to 3RF22 solid-state relays with screw terminals		5				
		Spring-loaded terminals 3RF2900-2TA88		1	50 units	41C
Replacement control connectors For 3RF20 to 3RF22 solid-state relays with spring-loaded terminals		5				
		Control connectors 3RF2900-2TB88		1	10 units	41C
Control connectors For 3RF20 to 3RF22 solid-state relays Spring-loaded terminals with two clamping points per contact		5				
Tools for opening spring-loaded terminals						
		Screwdrivers 3RA2908-1A		1	1 unit	41B
Screwdrivers For all SIRIUS devices with spring-loaded terminals Length approx. 200 mm, size 3.0 mm x 0.5 mm, titanium gray/black, partially insulated		2				
Blank labels						
		Unit labeling plates 3RT2900-1SB20		100	340 units	41B
Unit labeling plates For SIRIUS devices ¹⁾ 20 mm x 7 mm, titanium gray		20				
		Adhesive labels 3RT2900-1SB60		100	3060 units	41B
Adhesive labels For SIRIUS devices 19 mm x 6 mm, titanium gray		5				

¹⁾ PC labeling systems for individual inscription of unit labeling plates available from: murrplastik Systemtechnik GmbH (see page 16/16).

Switching devices – Soft starters and solid-state switching devices

Solid-state switching devices for resistive/inductive loads

Solid-state relays

SIRIUS 3RF20 solid-state relays, 1-phase, 45 mm

Overview

1-phase solid-state relays (without heat sink) with a width of 45 mm

The solid-state relays with a width of 45 mm provide for connection of the power supply lead and the load from above. This makes it easy to replace existing solid-state relays in existing arrangements.



The connection of the control cable is as space-saving as the 22.5 mm design, as it is simply plugged on.

Technical specifications

More information

System Manual for modular system, see <https://support.industry.siemens.com/cs/ww/en/view/60311318>

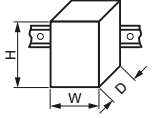
FAQs, see <https://support.industry.siemens.com/cs/ww/en/ps/16223/faq>

Type		3RF20..-1....	3RF20..-4....
Dimensions (W x H x D)	 mm	45 x 58 x 48	45 x 58 x 48
General data			
Ambient temperature			
• During operation, derating from 40 °C	°C	-25 ... +60	
• During storage	°C	-55 ... +80	
Installation altitude	m	0 ... 1 000; derating from 1 000	
Shock resistance acc. to IEC 60068-2-27	g/ms	15 / 11	
Vibration resistance acc. to IEC 60068-2-6	g	2	
Degree of protection IP on the front acc. to IEC 60529		IP20	
Touch protection on the front acc. to IEC 60529		Finger-safe for vertical touching from the front	
Electromagnetic compatibility (EMC)			
• Emitted interference			
- Conducted interference voltage acc. to IEC 60947-4-3		Class A for industrial applications	
- Emitted, high-frequency interference voltage acc. to IEC 60947-4-3		Class B for residential, business and commercial applications	
• Interference immunity			
- Electrostatic discharge acc. to IEC 61000-4-2 (corresponds to degree of severity 3)	kV	Contact discharge 4; air discharge 8; behavior criterion 2	
- Induced RF fields acc. to IEC 61000-4-6	MHz	0.15 ... 80; 140 dBµV; behavior criterion 1	
- Burst acc. to IEC 61000-4-4	kV	2/5.0 kHz; behavior criterion 2	
- Surge acc. to IEC 61000-4-5	kV	Conductor - ground 2; conductor - conductor 1; behavior criterion 2	
Mounting			
• Screws (not included in the scope of supply)		2 x M4	
• Tightening torque	Nm	1.5	
Connection type		 Screw terminals	 Spring-loaded terminals
Connection, main contacts			
• Conductor cross-sections			
- Solid	mm ²	2 x (1.5 ... 2.5) ¹⁾ , 2 x (2.5 ... 6) ¹⁾	--
- Finely stranded with end sleeve	mm ²	2 x (1 ... 2.5) ¹⁾ , 2 x (2.5 ... 6) ¹⁾ , 1 x 10	--
- Solid or stranded, AWG cables	AWG	2 x (14 ... 10)	--
• Terminal screw		M4	--
• Tightening torque	Nm	2 ... 2.5	--
	lb.in	7 ... 10.3	--
Connection, auxiliary/control contacts			
• Conductor cross-sections	mm ²	1 x (0.5 ... 2.5), 2 x (0.5 ... 1.0)	0.5 ... 2.5
	AWG	20 ... 12	20 ... 12
• Stripped length	mm	7	10
• Terminal screw		M3	--
• Tightening torque	Nm	0.5 ... 0.6	--
	lb.in	4.5 ... 5.3	--

¹⁾ If two different conductor cross-sections are connected to one clamping point, both cross-sections must lie in one of the ranges specified.

Switching devices – Soft starters and solid-state switching devices

Solid-state switching devices for resistive/inductive loads

Solid-state relays

SIRIUS 3RF20 solid-state relays, 1-phase, 45 mm

The heat transfer of the solid-state relays has been considerably improved. Please note the **highlighted values** when dimensioning the heat sink.

Type	$I_{\max}^{1)}$		I_e acc. to IEC 60947-4-3		I_e acc. to UL/CSA		Power loss	Minimum load current	Off-state current
	at $R_{thha}/T_u = 40\text{ °C}$		at $R_{thha}/T_u = 40\text{ °C}$		at $R_{thha}/T_u = 50\text{ °C}$				
	A	K/W	A	K/W	A	K/W	W	A	mA
Main circuit									
3RF2020-1.A..	20	2.00	20	1.70	20	1.30	28.6	0.1	10
3RF2030-1.A..	30	1.45	30	1.45	30	1.25	44.2	0.5	10
3RF2050-1.A..	50	0.85	50	0.85	50	0.70	66	0.5	10
3RF2070-1.A..	70	0.50	50	1.15	50	1.00	94	0.5	10
3RF2090-1.A..	88	0.55	50	1.40	50	1.00	118	0.5	10

¹⁾ The current I_{\max} provides information about the performance of the solid-state relay. The actual permitted rated operational current I_e can be smaller depending on the connection method and cooling conditions.

Note:

The required heat sinks for the corresponding load currents can be determined from the characteristic curves (see page 6/118, "More information"). The minimum thickness values for the mounting surface must be observed.

Type	Rated peak withstand current I_{tsm}	I^2t value
	A	A ² s
Main circuit		
3RF2020-1.A..	200	200
3RF2030-1.A.2	300	450
3RF2030-1.A.4	300	450
3RF2030-1.A.6	400	800
3RF2050-1.A..	600	1 800
3RF2070-1.A.2	1 200	7 200
3RF2070-1.A.4	1 200	7 200
3RF2070-1.A.5	1 200	7 200
3RF2070-1.A.6	1 150	6 600
3RF2090-1.A..	1 150	6 600

Type		3RF20.0-1.A.2	3RF20.0-1.A.4	3RF20.0-1.A.5	3RF20.0-1.A.6
Main circuit					
Rated operational voltage U_e	V AC	24 ... 230	48 ... 460	48 ... 600	
• Operating range	V AC	20 ... 253	40 ... 506	40 ... 660	
• Rated frequency	Hz	50/60 ± 10%			
Rated insulation voltage U_i	V	600			
Blocking voltage	V	800	1 200		1 600
Rate of voltage rise	V/μs	1 000			

Type		3RF20.0-1.A.0.	3RF20.0-1.A.2.	3RF20.0-1.A.4.
Control circuit				
Method of operation		DC operation		AC operation
Rated control supply voltage U_s	V	24	110 ... 230	4 ... 30
Rated frequency of the control supply voltage	Hz	--	50/60 ± 10%	--
Control supply voltage, max.	V	30	253	30
Typical actuating current	mA	15	15	15
Response voltage	V	15	90	4
Drop-out voltage	V	5	40	1
Operating times				
• ON-delay	ms	1 + max. one half-wave ¹⁾	40 + max. one half-wave ¹⁾	1 + max. one half-wave ¹⁾
• OFF-delay	ms	1 + max. one half-wave	40 + max. one half-wave	1 + max. one half-wave

¹⁾ Only for zero-point switching devices.

Switching devices – Soft starters and solid-state switching devices



Solid-state switching devices for resistive/inductive loads

Solid-state relays

SIRIUS 3RF20 solid-state relays, 1-phase, 45 mm

Selection and ordering data

1-phase solid-state relays (without heat sink) with a width of 45 mm

Type current/ performance capacity ¹⁾	Rated control supply voltage U_s	SD	Screw terminals 	PU (UNIT, SET, M)	PS*	PG
A	V	d	Article No.	Price per PU		
Zero-point switching, rated operational voltage U_e 24 ... 230 V AC						
	20	24 DC	2	3RF2020-1AA02	1	1 unit 41C
	30		2	3RF2030-1AA02	1	1 unit 41C
	50		2	3RF2050-1AA02	1	1 unit 41C
	70 ²⁾		2	3RF2070-1AA02	1	1 unit 41C
	90 ²⁾		2	3RF2090-1AA02	1	1 unit 41C
	20	110 ... 230 AC	2	3RF2020-1AA22	1	1 unit 41C
	30		2	3RF2030-1AA22	1	1 unit 41C
	50		2	3RF2050-1AA22	1	1 unit 41C
	70 ²⁾		5	3RF2070-1AA22	1	1 unit 41C
	90 ²⁾		5	3RF2090-1AA22	1	1 unit 41C
3RF2020-1AA02	20	4 ... 30 DC	5	3RF2020-1AA42	1	1 unit 41C
	30		5	3RF2030-1AA42	1	1 unit 41C
Zero-point switching, rated operational voltage U_e 48 ... 460 V AC						
20	24 DC	2	3RF2020-1AA04	1	1 unit 41C	
30		2	3RF2030-1AA04	1	1 unit 41C	
50		2	3RF2050-1AA04	1	1 unit 41C	
70 ²⁾		2	3RF2070-1AA04	1	1 unit 41C	
90 ²⁾		2	3RF2090-1AA04	1	1 unit 41C	
20	110 ... 230 AC	5	3RF2020-1AA24	1	1 unit 41C	
30		5	3RF2030-1AA24	1	1 unit 41C	
50		5	3RF2050-1AA24	1	1 unit 41C	
70 ²⁾		5	3RF2070-1AA24	1	1 unit 41C	
90 ²⁾		5	3RF2090-1AA24	1	1 unit 41C	
50	4 ... 30 DC	2	3RF2050-1AA44	1	1 unit 41C	
Zero-point switching, rated operational voltage U_e 48 ... 600 V AC						
20	4 ... 30 DC	5	3RF2020-1AA45	1	1 unit 41C	
50		5	3RF2050-1AA45	1	1 unit 41C	
70 ²⁾		2	3RF2070-1AA45	1	1 unit 41C	
90 ²⁾		5	3RF2090-1AA45	1	1 unit 41C	
Zero-point switching · Blocking voltage 1 600 V, rated operational voltage U_e 48 ... 600 V AC						
30	24 DC	5	3RF2030-1AA06	1	1 unit 41C	
50		5	3RF2050-1AA06	1	1 unit 41C	
70 ²⁾		5	3RF2070-1AA06	1	1 unit 41C	
90 ²⁾		5	3RF2090-1AA06	1	1 unit 41C	
30	110 ... 230 AC	5	3RF2030-1AA26	1	1 unit 41C	
50		5	3RF2050-1AA26	1	1 unit 41C	
70 ²⁾		5	3RF2070-1AA26	1	1 unit 41C	
90 ²⁾		5	3RF2090-1AA26	1	1 unit 41C	
Instantaneous switching, rated operational voltage U_e 48 ... 460 V AC						
30	24 DC	5	3RF2030-1BA04	1	1 unit 41C	

¹⁾ The type current provides information about the performance capacity of the solid-state relay. The actual permitted rated operational current I_e can be smaller depending on the connection method and cooling conditions.

²⁾ Please note that this version with an M4 screw connection can only be used for a rated current of up to approx. 50 A and a conductor cross-section of 10 mm².

For accessories, see page 6/125.

Switching devices – Soft starters and solid-state switching devices

Solid-state switching devices for resistive/inductive loads

Solid-state relays

SIRIUS 3RF20 solid-state relays, 1-phase, 45 mm

Type current/ performance capacity ¹⁾	Rated control supply voltage U_s	SD	Screw terminals + spring-loaded terminals (control current side)	PU (UNIT, SET, M)	PS*	PG
A	V	d	Article No.	Price per PU		
Zero-point switching, rated operational voltage U_e 24 ... 230 V AC						
50	24 DC	5	3RF2050-4AA02		1	1 unit 41C



3RF2050-4AA02

¹⁾ The type current provides information about the performance capacity of the solid-state relay. The actual permitted rated operational current I_e can be smaller depending on the connection method and cooling conditions.

For accessories, see page 6/125.

Switching devices – Soft starters and solid-state switching devices

Solid-state switching devices for resistive/inductive loads

Solid-state relays

SIRIUS 3RF22 solid-state relays, 3-phase, 45 mm

Overview

3-phase solid-state relays (without heat sink) with a width of 45 mm

With its compact design and a width of just 45 mm, which stays the same even at currents of up to 55 A, the 3RF22 solid-state relay offers an ultra small footprint. The logical connection method, with the power infeed from above and load connection from below, ensures tidy installation in the control cabinet.

Important features:

- LED display
- Variety of connection methods, also with high degree of protection
- Plug-in control connection
- Zero-point switching, 2 or 3-phase controlled

Technical specifications



More information

System Manual for modular system, see <https://support.industry.siemens.com/cs/ww/en/view/60311318>

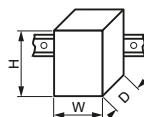
FAQs, see <https://support.industry.siemens.com/cs/ww/en/ps/16223/faq>

Type		3RF22..-1....	3RF22..-2....	3RF22..-3....
Dimensions (W x H x D)	 mm	45 x 95 x 47	45 x 95 x 47	45 x 95 x 47

General data

Ambient temperature				
• During operation, derating from 40 °C	°C	-25 ... +60		
• During storage	°C	-55 ... +80		
Installation altitude	m	0 ... 1 000; > 1 000 ask Technical Support		
Shock resistance acc. to IEC 60068-2-27	g/ms	15/11		
Vibration resistance acc. to IEC 60068-2-6	g	2		
Degree of protection IP on the front acc. to IEC 60529		IP20		IP00
Touch protection on the front acc. to IEC 60529		Finger-safe for vertical touching from the front		--
Insulation strength at 50/60 Hz (main/control circuit to floor)	V rms	4 000		
Electromagnetic compatibility (EMC)				
• Emitted interference				
- Conducted interference voltage acc. to IEC 60947-4-3				Class A for industrial applications ¹⁾
• Interference immunity				
- Electrostatic discharge acc. to IEC 61000-4-2 (corresponds to degree of severity 3)	kV			Contact discharge 4; air discharge 8; behavior criterion 2
- Induced RF fields acc. to IEC 61000-4-6	MHz	0.15 ... 80; 140 dBµV; behavior criterion 1		
- Burst acc. to IEC 61000-4-4	kV	2/5.0 kHz; behavior criterion 2		
- Surge acc. to IEC 61000-4-5	kV	Conductor - ground 2; conductor - conductor 1; behavior criterion 2		
Mounting				
• Screws (not included in the scope of supply)		2 x M4		
• Tightening torque	Nm	1.5		
Connection type		 Screw terminals	 Spring-loaded terminals	 Ring terminal lug connection
Connection, main contacts				
• Conductor cross-sections				
- Solid	mm ²	2 x (1.5 ... 2.5) ²⁾ , 2 x (2.5 ... 6) ²⁾	2 x (0.5 ... 2.5)	--
- Finely stranded with end sleeve	mm ²	2 x (1 ... 2.5) ²⁾ , 2 x (2.5 ... 6) ²⁾ , 1 x 10	2 x (0.5 ... 1.5)	--
- Finely stranded without end sleeve	mm ²	--	2 x (0.5 ... 2.5)	--
- Solid or stranded, AWG cables	AWG	2 x (14 ... 10)	2 x (18 ... 14)	--
• Stripped length	mm	10	10	--
• Terminal screws		M4	--	M5
- Tightening torque, Ø 5 ... 6 mm, PZ 2	Nm	2 ... 2.5		2 ... 2.5
	lb.in	18 ... 22		18 ... 22
• Cable lugs				
- According to DIN 46234		--	--	5-2.5 ... 5-25
- According to JIS C 2805		--	--	R 2-5 ... R 14-5
- Width, maximum	mm	--	--	12
Connection, auxiliary/control contacts				
• Conductor cross-sections, with or without end sleeve	mm	1 x (0.5 ... 2.5), 2 x (0.5 ... 1.0)	0.5 ... 2.5	1 x (0.5 ... 2.5), 2 x (0.5 ... 1.0)
• Stripped length	mm	20 ... 12	20 ... 12	20 ... 12
• Terminal screw		M3	--	M3
- Tightening torque, Ø 3.5 mm, PZ 1	Nm	0.5 ... 0.6		0.5 ... 0.6
	lb.in	4.5 ... 5.3		4.5 ... 5.3

¹⁾ These products were built as Class A devices. The use of these devices in residential areas could result in radio interference. In this case it may be required to introduce additional interference suppression measures.

²⁾ If two different conductor cross-sections are connected to one clamping point, both cross-sections must lie in one of the ranges specified.

Switching devices – Soft starters and solid-state switching devices

Solid-state switching devices for resistive/inductive loads

Solid-state relays

SIRIUS 3RF22 solid-state relays, 3-phase, 45 mm

The heat transfer of the solid-state relays has been considerably improved. Please note the **highlighted values** when dimensioning the heat sink.

Type	$I_{\max}^{1)}$ at $R_{\text{thha}}/T_u = 40\text{ °C}$		I_e acc. to IEC 60947-4-3 at $R_{\text{thha}}/T_u = 40\text{ °C}$		I_e acc. to UL/CSA at $R_{\text{thha}}/T_u = 50\text{ °C}$		Power loss at I_{\max} W	Minimum load current A	Max. off-state current mA
	A	K/W	A	K/W	A	K/W			
Main circuit									
3RF2230-1AB..	30	0.80	30	0.80	30	0.65	81	0.5	10
3RF2230-2AB..			20	1.36	20	1.15			
3RF2230-3AB..			30	0.80	30	0.65			
3RF2255-1AB..	55	0.25	50	0.35	50	0.15	151	0.5	10
3RF2255-2AB..			20	1.83	20	1.58			
3RF2255-3AB..			55	0.25	55	0.15			
3RF2230-1AC..	30	0.45	30	0.45	30	0.35	122	0.5	10
3RF2230-2AC..			20	0.86	20	0.72			
3RF2230-3AC..			30	0.45	30	0.35			
3RF2255-1AC..	55	0.14	50	0.20	50	0.12	226	0.5	10
3RF2255-2AC..			20	1.19	20	1.02			
3RF2255-3AC..			55	0.14	55	0.12			

¹⁾ The current I_{\max} provides information about the performance of the solid-state relay. The actual permitted rated operational current I_e can be smaller depending on the connection method and cooling conditions.

Note:

The required heat sinks for the corresponding load currents can be determined from the characteristic curves (see page 6/118, "More information"). The minimum thickness values for the mounting surface must be observed.

Type	Rated peak withstand current I_{tsm}		I^2t value A ² s
	A	A	
Main circuit			
3RF2230-....5	300		450
3RF2255-....5	600		1 800

Type	3RF22...-AB.5		3RF22...-AC.5	
Main circuit				
Controlled phases	2-phase		3-phase	
Rated operational voltage U_e	V AC	48 ... 600		
• Operating range	V AC	40 ... 660		
• Rated frequency	Hz	50/60 ± 10%		
Rated insulation voltage U_i	V	600		
Rated impulse withstand voltage U_{imp}	kV	6		
Blocking voltage	V	1 200		
Rate of voltage rise	V/μs	1 000		

Type	3RF22...-A.3.		3RF22...-A.4.	
Control circuit				
Method of operation	AC operation		DC operation	
Rated control supply voltage U_s	V	110	4 ... 30	
Rated frequency of the control supply voltage	Hz	50/60 ± 10%	--	
Control supply voltage, max.	V	121	30	
Typical actuating current	mA	15	30	
Response voltage	V	90	4	
Drop-out voltage	V	< 40	1	
Operating times				
• ON-delay	ms	40 + max. one half-wave	1 + max. one half-wave	
• OFF-delay	ms	40 + max. one half-wave	1 + max. one half-wave	

Switching devices – Soft starters and solid-state switching devices

Solid-state switching devices for resistive/inductive loads

Solid-state relays

SIRIUS 3RF22 solid-state relays, 3-phase, 45 mm

Selection and ordering data

Type current/ performance capacity ¹⁾	Rated control supply voltage U_s	SD	Screw terminals 	PU (UNIT, SET, M)	PS*	PG
A	V	d	Article No.	Price per PU		
Zero-point switching, rated operational voltage U_e 48 ... 600 V AC						
2-phase controlled						
30	110 AC	5	3RF2230-1AB35	1	1 unit	41C
55 ²⁾		5	3RF2255-1AB35	1	1 unit	41C
30	4 ... 30 DC	5	3RF2230-1AB45	1	1 unit	41C
55 ²⁾		5	3RF2255-1AB45	1	1 unit	41C
3-phase controlled						
30	110 AC	5	3RF2230-1AC35	1	1 unit	41C
55 ²⁾		5	3RF2255-1AC35	1	1 unit	41C
30	4 ... 30 DC	2	3RF2230-1AC45	1	1 unit	41C
55 ²⁾		5	3RF2255-1AC45	1	1 unit	41C



3RF2230-1AB35

- 1) The type current provides information about the performance capacity of the solid-state relay. The actual permitted rated operational current I_e can be smaller depending on the connection method and cooling conditions.
- 2) Please note that the version with an M4 screw connection can only be used for a rated current of up to approx. 50 A and a conductor cross-section of 10 mm². Please use the 3RF22 solid-state relays with ring terminal lugs for these currents.

For accessories, see page 6/125.

Type current/ performance capacity ¹⁾	Rated control supply voltage U_s	SD	Spring-loaded terminals 	PU (UNIT, SET, M)	PS*	PG
A	V	d	Article No.	Price per PU		

Zero-point switching, rated operational voltage U_e 48 ... 600 V AC						
2-phase controlled						
30 ²⁾	4 ... 30 DC	5	3RF2230-2AB45	1	1 unit	41C
55 ²⁾		5	3RF2255-2AB45	1	1 unit	41C
3-phase controlled						
30 ²⁾	4 ... 30 DC	5	3RF2230-2AC45	1	1 unit	41C
55 ²⁾		5	3RF2255-2AC45	1	1 unit	41C



3RF2230-2AB45

- 1) The type current provides information about the performance capacity of the solid-state relay. The actual permitted rated operational current I_e can be smaller depending on the connection method and cooling conditions.
- 2) Please note that the version with spring-loaded terminals can only be used for a rated current of up to approx. 20 A and a conductor cross-section of 2.5 mm². Higher currents can be achieved by connecting two conductors per terminal.

For accessories, see page 6/125.

Type current/ performance capacity ¹⁾	Rated control supply voltage U_s	SD	Ring terminal lug connection 	PU (UNIT, SET, M)	PS*	PG
A	V	d	Article No.	Price per PU		

Zero-point switching, rated operational voltage U_e 48 ... 600 V AC						
2-phase controlled						
30	4 ... 30 DC	5	3RF2230-3AB45	1	1 unit	41C
55		5	3RF2255-3AB45	1	1 unit	41C
3-phase controlled						
30	4 ... 30 DC	5	3RF2230-3AC45	1	1 unit	41C
55		5	3RF2255-3AC45	1	1 unit	41C



3RF2230-3AB45

- 1) The type current provides information about the performance capacity of the solid-state relay. The actual permitted rated operational current I_e can be smaller depending on the connection method and cooling conditions.

For accessories, see page 6/125.

Switching devices – Soft starters and solid-state switching devices

Solid-state switching devices for resistive/inductive loads

Solid-state contactors

General data

Overview

Solid-state contactors (with integrated heat sink)

The solid-state contactors are available in two different versions:

- 3RF23 1-phase solid-state contactors
- 3RF24 3-phase solid-state contactors

The complete units consist of a solid-state relay plus optimized heat sink, and are therefore ready to use. They offer defined rated currents to make selection as easy as possible.

Depending on the version, current strengths of up to 70 A are achieved. Like all of our solid-state switching devices, one of their particular advantages is their compact and space-saving design.

Thanks to optimized power electronics, versions of 3RF2310 to 3RF2330 solid-state contactors can be mounted side-by-side without derating, [see product information or product data sheets for the individual products](#).

Note:

Due to a special mounting foot, snapping onto grounded standard mounting rails simultaneously provides safe grounding of the heat sink. Additional grounding is no longer necessary in this case. With other mounting types, an additional ground connection to the heat sink can be established by means of a screw terminal connection.

3RF23 1-phase solid-state contactors

Version for resistive loads "zero-point switching"

This standard version is often used for switching heaters on and off.

Version for inductive loads "instantaneous switching"

In this version, the solid-state contactor is specifically matched to inductive loads. Whether it is a matter of frequent actuation of the valves in a filling plant or starting and stopping small operating mechanisms in packet distribution systems, operation is carried out safely and noiselessly.

Special "low noise" version

Thanks to a special control circuit, this special version can be used in public networks up to 16 A without any additional measures such as interference suppressor filters. As a result, in terms of emitted interference, it conforms to limit value curve class B according to IEC 60947-4-3.

Special "short-circuit-proof" version

Skillful matching of the power semiconductor with the performance capacity of the solid-state contactor means that "short-circuit strength" can be achieved with a standard miniature circuit breaker. In combination with a B MCB or a conventional line protection fuse, the result is a short-circuit proof feeder.

In order to achieve problem-free short-circuit protection by means of miniature circuit breakers, however, certain constraints must be observed. As the magnitude and duration of the short-circuit current are determined not only by the short-circuit breaking response of the miniature circuit breaker but also the properties of the wiring system, such as the internal resistance of the input to the network and damping by controls and cables, particular attention must also be paid to these parameters. The necessary cable lengths are therefore shown for the main factor, the line resistance, in the table below.

In systems that have high voltage peaks or at voltages of 575 V and higher, use of versions with a blocking voltage of 1 600 V is recommended.

The following miniature circuit breakers with a B characteristic and 10 kA or 6 kA breaking capacity protect the 3RF23...-DA.. solid-state contactors in the event of short circuits on the load and the specified conductor cross-sections and lengths:

Rated current of the miniature circuit breaker	Example of type ¹⁾	Max. conductor cross-section	Minimum cable length from contactor to load
6 A	5SY4106-6	1 mm ²	5 m
10 A	5SY4110-6	1.5 mm ²	8 m
16 A	5SY4116-6	1.5 mm ²	12 m
		2.5 mm ²	20 m
20 A	5SY4120-6	2.5 mm ²	20 m
25 A	5SY4125-6	2.5 mm ²	26 m

¹⁾ The miniature circuit breakers can be used up to a maximum rated voltage of 480 V!

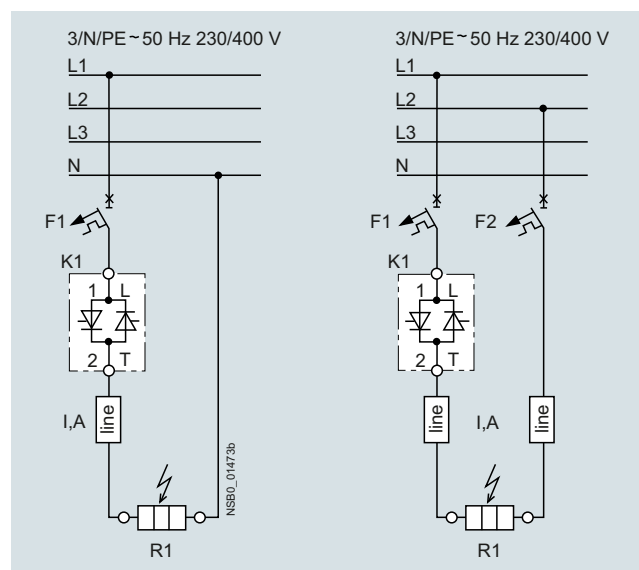

Solid-state contactor protection

The setup and installation above can also be used for the solid-state relays with an I^2t value of at least 6 600 A²s.

Function modules

The 3RF23 solid-state contactors can be expanded with various function modules for individual adaptation to applications, [see page 6/148 onwards](#).

3RF24 3-phase solid-state contactors

The 3-phase solid-state contactors for resistive loads up to 50 A are available with

- 2-phase control (suitable in particular for circuits without connection to the neutral conductor) and
- 3-phase control (suitable for star circuits with connection to the neutral conductor or for applications in which the system requires all phases to be switched)

The converter function module can be snapped onto both versions for the simple power control of three-phase networks by means of analog signals.

Note:

Checking the correct solid-state contactor size with the aid of the rated current diagram, taking account of the installation conditions, is recommended.

Switching devices – Soft starters and solid-state switching devices

Solid-state switching devices for resistive/inductive loads

Solid-state contactors

SIRIUS 3RF23 solid-state contactors, 1-phase

Overview

1-phase solid-state contactors with heat sink

Their compact design with optimized heat sink enables small complete units with currents up to 70 A.

It also offers all the special features of the solid-state relay in terms of time and space savings.



Technical specifications

More information

System Manual for modular system, see <https://support.industry.siemens.com/cs/ww/en/view/60311318>

FAQs, see <https://support.industry.siemens.com/cs/ww/en/ps/16223/faq>

Type	3RF23...-A...	3RF23...-B...	3RF23...-C...	3RF23...-D...
Dimensions (W x H x D)	See page 6/135			
General data				
Ambient temperature				
• During operation, derating from 40 °C	°C	-25 ... +60		
• During storage	°C	-55 ... +80		
Installation altitude	m	0 ... 1 000; derating from 1 000		
Shock resistance acc. to IEC 60068-2-27	g/ms	15/11		
Vibration resistance acc. to IEC 60068-2-6	g	2		
Degree of protection IP on the front acc. to IEC 60529				
• Screw terminals and spring-loaded terminals	IP20			
• Ring terminal lug connection	IP00 (IP20 when using the 3RF2900-3PA88 terminal cover)			
Touch protection on the front acc. to IEC 60529				
• Screw terminals and spring-loaded terminals	Finger-safe for vertical touching from the front			
• Ring terminal lug connection	Finger-safe for vertical touching from the front when using the 3RF2900-3PA88 terminal cover			
Electromagnetic compatibility (EMC)				
• Emitted interference according to IEC 60947-4-3 - Conducted interference voltage		Class A for industrial applications	Class A for industrial applications; Class B for residential, business and commercial applications up to 16 A, AC-51 Low Noise	Class A for industrial applications
- Emitted, high-frequency interference voltage		Class B for residential, business and commercial applications		
• Interference immunity		Contact discharge 4; air discharge 8; behavior criterion 2		
- Electrostatic discharge acc. to IEC 61000-4-2 (corresponds to degree of severity 3)	kV			
- Induced RF fields acc. to IEC 61000-4-6	MHz	0.15 ... 80; 140 dBµV; behavior criterion 1		
- Burst acc. to IEC 61000-4-4	kV	2/5.0 kHz; behavior criterion 2		
- Surge acc. to IEC 61000-4-5	kV	Conductor - ground 2; conductor - conductor 1; behavior criterion 2		

Type	3RF23...-1....	3RF23...-2....	3RF23...-3....
General data			
Connection type	 Screw terminals	 Spring-loaded terminals	 Ring terminal lug connection
Connection, main contacts			
• Conductor cross-section			
- Solid	mm ²	2 x (1.5 ... 2.5) ¹⁾ , 2 x (2.5 ... 6) ¹⁾	2 x (0.5 ... 2.5)
- Finely stranded with end sleeve	mm ²	2 x (1 ... 2.5) ¹⁾ , 2 x (2.5 ... 6) ¹⁾ , 1 x 10	2 x (0.5 ... 1.5)
- Finely stranded without end sleeve	mm ²	--	2 x (0.5 ... 2.5)
- Solid or stranded, AWG cables	AWG	2 x (14 ... 10)	2 x (18 ... 14)
• Terminal screws		M4	M5
• Tightening torque	Nm	2 ... 2.5	2 ... 2.5
	lb.in	7 ... 10.3	7 ... 10.3
• Cable lugs			
- According to DIN 46234	--	--	5-2.5, 5-6, 5-10, 5-16, 5-25
- According to JIS C 2805	--	--	R 2-5, R 5.5-5, R 8-5, R 14-5
- Width, maximum	mm	--	12
Connection, auxiliary/control contacts			
• Conductor cross-section	mm	1 x (0.5 ... 2.5), 2 x (0.5 ... 1.0)	1 x (0.5 ... 2.5), 2 x (0.5 ... 1.0)
	AWG	20 ... 12	20 ... 12
• Stripped length	mm	7	7
• Terminal screw		M3	M3
• Tightening torque	Nm	0.5 ... 0.6	0.5 ... 0.6
	lb.in	4.5 ... 5.3	4.5 ... 5.3



¹⁾ If two different conductor cross-sections are connected to one clamping point, both cross-sections must lie in one of the ranges specified.

Switching devices – Soft starters and solid-state switching devices

Solid-state switching devices for resistive/inductive loads

Solid-state contactors

SIRIUS 3RF23 solid-state contactors, 1-phase

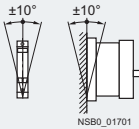
Type	3RF23..-1....	3RF23..-2....	3RF23..-3....
General data			
Connection type	 Screw terminals	 Spring-loaded terminals	 Ring terminal lug connection
Grounding studs	Optional, see also note on page 6/133 about the special mounting foot for safe grounding on standard mounting rails		
• Size (standard screw)	M5		
Permissible mounting position			

Type	3RF23..-....2	3RF23..-....4	3RF23..-....5	3RF23..-....6
Main circuit				
Rated operational voltage U_e	V AC	24 ... 230	48 ... 460	48 ... 600
• Operating range	V AC	20 ... 253	40 ... 506	40 ... 660
• Rated frequency	Hz	50/60 ± 10%		
Rated insulation voltage U_i	V	600		
Blocking voltage	V	800	1 200	1 600
Rate of voltage rise	V/μs	1 000		

Type	3RF23..-....0.	3RF23..-....1.	3RF23..-....2.	3RF23..-....4.
Control circuit				
Method of operation		DC operation	AC/DC operation	AC operation
Rated control supply voltage U_s	V	24 DC	24 AC 24 DC	110 ... 230 AC
Rated frequency of the control supply voltage	Hz	--	50/60 ± 10%	50/60 ± 10%
Actuating voltage, max.	V	30	26.5 AC 30 DC	253
Typical actuating current	mA	15 / Low Power: 9 ¹⁾	20 20	15
Response voltage	V	15	14 AC 15 DC	90
Drop-out voltage	V	5	5 AC 5 DC	40
Operating times				
• ON-delay	ms	1 + max. one half-wave ²⁾	10 + max. one half-wave ²⁾	40 + max. one half-wave ²⁾
• OFF-delay	ms	1 + max. one half-wave	15 + max. one half-wave	40 + max. one half-wave

¹⁾ Applies to the "Low Power" version 3RF23..-AA..-0KN0.

²⁾ Only for zero-point switching devices.

Type	Type current/performance capacity ¹⁾ I_{AC-51}	Dimensions (W x H x D) incl. heat sink
	A	mm
Main circuit		
3RF2310..AA..	10.5	22.5 x 95 x 84
3RF2320..AA.. 3RF2320..CA.. 3RF2320..DA..	20	22.5 x 95 x 116.5
3RF2330..AA.. 3RF2330..CA.. 3RF2330..DA..	30	45 x 95 x 131.5 22.5 x 95 x 116.5
3RF2340..AA..	40	67.5 x 95 x 133.5
3RF2350..AA..	50	67.5 x 95 x 133.5
3RF2370..AA..	70	80 x 95 x 154.5

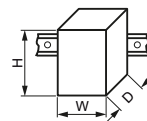

¹⁾ The type current provides information about the performance of the solid-state contactor. The actual permitted rated operational current I_e can be smaller depending on the installation conditions.

Switching devices – Soft starters and solid-state switching devices

Solid-state switching devices for resistive/inductive loads

Solid-state contactors

SIRIUS 3RF23 solid-state contactors, 1-phase

Type	Type current AC-51/performance capacity ¹⁾			Power loss at I_{max}	Minimum load current	Off-state current	Rated peak withstand current I_{tsm}	I^2t value
	at I_{max} at 40 °C	Acc. to IEC 60947-4-3 at 40 °C	Acc. to UL/CSA at 50 °C					
	A	A	A	W	A	mA	A	A ² s
Main circuit								
3RF2310-.AA.2 3RF2310-.AA.4 3RF2310-.AA.5 3RF2310-.AA.6	10.5	7.5	9.6	11	0.1	10	200	200
							400	800
3RF2320-.AA.2 3RF2320-.AA.4 3RF2320-.AA.5 3RF2320-.AA.6 3RF2320-.CA.2 3RF2320-.CA.4 3RF2320-.DA.2 3RF2320-.DA.4	20	13.2	17.6	20	0.5	10	600	1 800
						25	600	1 800
						10	1 150	6 600
3RF2330-.AA.2 3RF2330-.AA.4 3RF2330-.AA.5 3RF2330-.AA.6 3RF2330-.CA.2 3RF2330-.DA.4	30	22	27	33	0.5	10	600	1 800
						25	600	1 800
		18.5	26	33	0.5	10	1 150	6 600
3RF2340-.AA.2 3RF2340-.AA.4 3RF2340-.AA.5 3RF2340-.AA.6	40	33	36	44	0.5	10	1 200	7 200
							1 150	6 600
3RF2350-.AA.2 3RF2350-.AA.4 3RF2350-.AA.5 3RF2350-.AA.6	50	36	45	54	0.5	10	1 150	6 600
3RF2370-.AA.2 3RF2370-.AA.4 3RF2370-.AA.5 3RF2370-.AA.6	70	70	62	83	0.5	10	1 150	6 600

¹⁾ The type current provides information about the performance of the solid-state contactor. The actual permitted rated operational current I_e can be smaller depending on the installation conditions.

Type	Type current AC-51/performance capacity ¹⁾			Type current AC-15/performance capacity ¹⁾		Power loss at I_{max}	Minimum load current	Off-state current	Rated peak withstand current I_{tsm}	I^2t value
	at I_{max} at 40 °C	Acc. to IEC 60947-4-3 at 40 °C	Acc. to UL/CSA at 50 °C	$10 \times I_e$ for 60 ms	Parameters					
	A	A	A	A		W	A	mA	A	A ² s
Main circuit										
3RF2310-.BA.2 3RF2310-.BA.4 3RF2310-.BA.6	10.5	7.5	9.6	6	1 200 1/h 50% ON period	11	0.1	10	200	200
									400	800
3RF2320-.BA.2 3RF2320-.BA.4 3RF2320-.BA.6	20	13.2	17.6	12	1 200 1/h 50% ON period	20	0.5	10	600	1 800
3RF2330-.BA.2 3RF2330-.BA.4 3RF2330-.BA.6	30	22	27	15	1 200 1/h 50% ON period	33	0.5	10	600	1 800
3RF2340-.BA.2 3RF2340-.BA.4 3RF2340-.BA.6	40	33	36	20	1 200 1/h 50% ON period	44	0.5	10	1 200	7 200
									1 150	6 600
3RF2350-.BA.2 3RF2350-.BA.4 3RF2350-.BA.6	50	36	45	25	1 200 1/h 50% ON period	54	0.5	10	1 150	6 600
3RF2370-.BA.2 3RF2370-.BA.4 3RF2370-.BA.6	70	70	62	27.5	1 200 1/h 50% ON period	83	0.5	10	1 150	6 600

¹⁾ The type current provides information about the performance of the solid-state contactor. The actual permitted rated operational current I_e can be smaller depending on the installation conditions.

Switching devices – Soft starters and solid-state switching devices

Solid-state switching devices for resistive/inductive loads

Solid-state contactors

SIRIUS 3RF23 solid-state contactors, 1-phase



Selection and ordering data

Selection notes

The solid-state contactors are selected on the basis of details of the network, the load and the ambient conditions. As the solid-state contactors are already equipped with an optimally matched heat sink, the selection process is considerably simpler than that for solid-state relays.

The following procedure is recommended:

- Determine the rated current of the load and the mains voltage
- Select a solid-state contactor with the same or higher rated current than the load

	Type current/ performance capacity ¹⁾ I_{max}	Rated control supply voltage U_s	SD	Screw terminals	PU (UNIT, SET, M)	PS*	PG
	A	V	d	Article No.			
Zero-point switching · Integrated heat sink, rated operational voltage U_e 24 ... 230 V AC							
 3RF2310-1	10.5	24 DC	2	3RF2310-1AA02	1	1 unit	41C
	20		2	3RF2320-1AA02	1	1 unit	41C
	30		2	3RF2330-1AA02	1	1 unit	41C
	40		2	3RF2340-1AA02	1	1 unit	41C
	50		2	3RF2350-1AA02	1	1 unit	41C
	20	24 DC Low Power	2	3RF2320-1AA02-0KN0	1	1 unit	41C
	10.5	24 AC/DC	2	3RF2310-1AA12	1	1 unit	41C
	10.5	110 ... 230 AC	2	3RF2310-1AA22	1	1 unit	41C
	20		2	3RF2320-1AA22	1	1 unit	41C
	30		2	3RF2330-1AA22	1	1 unit	41C
	40		5	3RF2340-1AA22	1	1 unit	41C
	50		2	3RF2350-1AA22	1	1 unit	41C
Zero-point switching · Integrated heat sink, rated operational voltage U_e 48 ... 460 V AC							
 3RF2320-1	10.5	24 DC	2	3RF2310-1AA04	1	1 unit	41C
	20		2	3RF2320-1AA04	1	1 unit	41C
	30		2	3RF2330-1AA04	1	1 unit	41C
	40		2	3RF2340-1AA04	1	1 unit	41C
	50		2	3RF2350-1AA04	1	1 unit	41C
	10.5	24 DC Low Power	2	3RF2310-1AA04-0KN0	1	1 unit	41C
	10.5	24 AC/DC	2	3RF2310-1AA14	1	1 unit	41C
	20		5	3RF2320-1AA14	1	1 unit	41C
	30		2	3RF2330-1AA14	1	1 unit	41C
	40		5	3RF2340-1AA14	1	1 unit	41C
	50		5	3RF2350-1AA14	1	1 unit	41C
	10.5	110 ... 230 AC	2	3RF2310-1AA24	1	1 unit	41C
	20		2	3RF2320-1AA24	1	1 unit	41C
	30		2	3RF2330-1AA24	1	1 unit	41C
	40		2	3RF2340-1AA24	1	1 unit	41C
	50		2	3RF2350-1AA24	1	1 unit	41C
	10.5	4 ... 30 DC	2	3RF2310-1AA44	1	1 unit	41C
	20		2	3RF2320-1AA44	1	1 unit	41C
	30		2	3RF2330-1AA44	1	1 unit	41C

¹⁾ The type current provides information about the performance of the solid-state contactor. The actual permitted rated operational current I_e can be smaller depending on the installation conditions. For derating characteristic curves, see page 6/118, "More information".

Other rated control supply voltages on request.





For accessories, see page 6/143.

Switching devices – Soft starters and solid-state switching devices

Solid-state switching devices for resistive/inductive loads

Solid-state contactors

SIRIUS 3RF23 solid-state contactors, 1-phase

Type current/ performance capacity ¹⁾ I_{max}	Rated control supply voltage U_s	SD	Screw terminals 	PU (UNIT, SET, M)	PS*	PG	
A	V	d	Article No.	Price per PU			
Zero-point switching · Integrated heat sink, rated operational voltage U_e 48 ... 600 V AC							
20	110 DC	X	3RF2320-1AA65	1	1 unit	41C	
30	110 ... 230 AC	5	3RF2330-1AA25	1	1 unit	41C	
10.5	4 ... 30 DC	5	3RF2310-1AA45	1	1 unit	41C	
20		2	3RF2320-1AA45	1	1 unit	41C	
30		2	3RF2330-1AA45	1	1 unit	41C	
40		2	3RF2340-1AA45	1	1 unit	41C	
50		2	3RF2350-1AA45	1	1 unit	41C	
Zero-point switching · Integrated heat sink, blocking voltage 1 600 V, rated operational voltage U_e 48 ... 600 V AC							
	10.5	24 DC	3RF2310-1AA06	1	1 unit	41C	
	20		3RF2320-1AA06	1	1 unit	41C	
	30		3RF2330-1AA06	1	1 unit	41C	
	40		3RF2340-1AA06	1	1 unit	41C	
	50		3RF2350-1AA06	1	1 unit	41C	
	10.5	110 ... 230 AC	5	3RF2310-1AA26	1	1 unit	41C
	20		5	3RF2320-1AA26	1	1 unit	41C
	30		5	3RF2330-1AA26	1	1 unit	41C
	40		5	3RF2340-1AA26	1	1 unit	41C
	50		5	3RF2350-1AA26	1	1 unit	41C
Low noise²⁾, zero-point switching · Integrated heat sink, rated operational voltage U_e 24 ... 230 V AC							
	20	24 DC	3RF2320-1CA02	1	1 unit	41C	
	30		3RF2330-1CA02	1	1 unit	41C	
	20	110 ... 230 AC	5	3RF2320-1CA22	1	1 unit	41C
Low noise²⁾, zero-point switching · Integrated heat sink, rated operational voltage U_e 48 ... 460 V AC							
20	24 DC	5	3RF2320-1CA04	1	1 unit	41C	
20	110 ... 230 AC	5	3RF2320-1CA24	1	1 unit	41C	
20	4 ... 30 DC	2	3RF2320-1CA44	1	1 unit	41C	
Short-circuit-proof with B MCB · Zero-point switching · Integrated heat sink, rated operational voltage U_e 24 ... 230 V AC							
20	24 DC	2	3RF2320-1DA02	1	1 unit	41C	
20	110 ... 230 AC	5	3RF2320-1DA22	1	1 unit	41C	
Short-circuit-proof with B MCB · Zero-point switching · Integrated heat sink, rated operational voltage U_e 48 ... 460 V AC							
	20	24 DC	3RF2320-1DA04	1	1 unit	41C	
	20	110 ... 230 AC	5	3RF2320-1DA24	1	1 unit	41C
	20	4 ... 30 DC	2	3RF2320-1DA44	1	1 unit	41C
	30		2	3RF2330-1DA44	1	1 unit	41C
	30	24 DC	5	3RF2330-1DA06	1	1 unit	41C
	30	24 DC	X	3RF2330-2DA64	1	1 unit	41C

¹⁾ The type current provides information about the performance of the solid-state contactor. The actual permitted rated operational current I_e can be smaller depending on the installation conditions.
For derating characteristic curves, see page 6/118, "More information".

²⁾ See page 6/133.

Other rated control supply voltages on request.





For accessories, see page 6/143.

Switching devices – Soft starters and solid-state switching devices

Solid-state switching devices for resistive/inductive loads

Solid-state contactors

SIRIUS 3RF23 solid-state contactors, 1-phase

	Type current/ performance capacity ¹⁾ I_{max}	Operational current I_e / AC-15 ²⁾	Rated control supply voltage U_s	SD	Screw terminals 	PU (UNIT, SET, M)	PS*	PG	
	A	A	V	d	Article No.	Price per PU			
Instantaneous switching - Integrated heat sink, rated operational voltage U_e 24 ... 230 V AC									
 3RF2310-1	10.5	6	24 DC	2	3RF2310-1BA02		1	1 unit 41C	
	20	12		2	3RF2320-1BA02		1	1 unit 41C	
	30	15		5	3RF2330-1BA02		1	1 unit 41C	
	40	20		5	3RF2340-1BA02		1	1 unit 41C	
	50	25		5	3RF2350-1BA02		1	1 unit 41C	
	50	27.5		5	3RF2370-1BA02		1	1 unit 41C	
	10.5	6	110 ... 230 AC	5	3RF2310-1BA22		1	1 unit 41C	
	20	12		5	3RF2320-1BA22		1	1 unit 41C	
	30	15		5	3RF2330-1BA22		1	1 unit 41C	
	40	20		5	3RF2340-1BA22		1	1 unit 41C	
	50	25		5	3RF2350-1BA22		1	1 unit 41C	
	50	27.5		5	3RF2370-1BA22		1	1 unit 41C	
	Instantaneous switching - Integrated heat sink, rated operational voltage U_e 48 ... 460 V AC								
	 3RF2320-1	10.5	6	24 DC	2	3RF2310-1BA04		1	1 unit 41C
20		12		2	3RF2320-1BA04		1	1 unit 41C	
30		15		2	3RF2330-1BA04		1	1 unit 41C	
40		20		5	3RF2340-1BA04		1	1 unit 41C	
50		25		5	3RF2350-1BA04		1	1 unit 41C	
50		27.5		5	3RF2370-1BA04		1	1 unit 41C	
10.5		6	110 ... 230 AC	5	3RF2310-1BA24		1	1 unit 41C	
20		12		5	3RF2320-1BA24		1	1 unit 41C	
30		15		5	3RF2330-1BA24		1	1 unit 41C	
40		20		5	3RF2340-1BA24		1	1 unit 41C	
50		25		5	3RF2350-1BA24		1	1 unit 41C	
50		27.5		5	3RF2370-1BA24		1	1 unit 41C	
20		12	4 ... 30 DC	5	3RF2320-1BA44		1	1 unit 41C	
30		15		5	3RF2330-1BA44		1	1 unit 41C	
50	25		5	3RF2350-1BA44		1	1 unit 41C		
Instantaneous switching - Integrated heat sink, blocking voltage 1 600 V, rated operational voltage U_e 48 ... 600 V AC									
 3RF2330-1	10.5	6	24 DC	5	3RF2310-1BA06		1	1 unit 41C	
	20	12		2	3RF2320-1BA06		1	1 unit 41C	
	30	15		5	3RF2330-1BA06		1	1 unit 41C	
	40	20		5	3RF2340-1BA06		1	1 unit 41C	
	50	25		5	3RF2350-1BA06		1	1 unit 41C	
	50	27.5		5	3RF2370-1BA06		1	1 unit 41C	
	10.5	6	110 ... 230 AC	5	3RF2310-1BA26		1	1 unit 41C	
	20	12		5	3RF2320-1BA26		1	1 unit 41C	
	30	15		5	3RF2330-1BA26		1	1 unit 41C	
	40	20		5	3RF2340-1BA26		1	1 unit 41C	
	50	25		5	3RF2350-1BA26		1	1 unit 41C	
	50	27.5		5	3RF2370-1BA26		1	1 unit 41C	

1) The type current provides information about the performance of the solid-state contactor. The actual permitted rated operational current I_e can be smaller depending on the installation conditions. For derating characteristic curves, see page 6/118, "More information".

2) Utilization category AC-15:
Electromagnetic loads, e.g. valves according to IEC 60947-5-1.
Parameters: max. 1 200 1/h, 50% ON period, 10-times inrush current for 60 ms.

Other rated control supply voltages on request.

For accessories, see page 6/143.

Switching devices – Soft starters and solid-state switching devices

Solid-state switching devices for resistive/inductive loads

Solid-state contactors

SIRIUS 3RF23 solid-state contactors, 1-phase

Type current/ performance capacity ¹⁾ I_{max}	Rated control supply voltage U_s	SD	Spring-loaded terminals	PU (UNIT, SET, M)	PS*	PG
A	V	d	Article No.	Price per PU		
Zero-point switching · Integrated heat sink, rated operational voltage U_e 24 ... 230 V AC						
10.5	24 DC	5	3RF2310-2AA02	1	1 unit	41C
20		2	3RF2320-2AA02	1	1 unit	41C
10.5	110 ... 230 AC	5	3RF2310-2AA22	1	1 unit	41C
20		5	3RF2320-2AA22	1	1 unit	41C
Zero-point switching · Integrated heat sink, rated operational voltage U_e 48 ... 460 V AC						
10.5	24 DC	2	3RF2310-2AA04	1	1 unit	41C
20		2	3RF2320-2AA04	1	1 unit	41C
10.5	110 ... 230 AC	5	3RF2310-2AA24	1	1 unit	41C
20		5	3RF2320-2AA24	1	1 unit	41C
Zero-point switching · Integrated heat sink, blocking voltage 1 600 V, rated operational voltage U_e 48 ... 600 V AC						
10.5	24 DC	5	3RF2310-2AA06	1	1 unit	41C
20		2	3RF2320-2AA06	1	1 unit	41C
10.5	110 ... 230 AC	5	3RF2310-2AA26	1	1 unit	41C
20		5	3RF2320-2AA26	1	1 unit	41C
Low noise²⁾, zero-point switching · Integrated heat sink, rated operational voltage U_e 24 ... 230 V AC						
20	24 DC	5	3RF2320-2CA02	1	1 unit	41C
20	110 ... 230 AC	5	3RF2320-2CA22	1	1 unit	41C
Low noise²⁾, zero-point switching · Integrated heat sink, rated operational voltage U_e 48 ... 460 V AC						
20	24 DC	5	3RF2320-2CA04	1	1 unit	41C
20	110 ... 230 AC	5	3RF2320-2CA24	1	1 unit	41C
Short-circuit-proof with B MCB, zero-point switching · Integrated heat sink, rated operational voltage U_e 24 ... 230 V AC						
20	110 ... 230 AC	5	3RF2320-2DA22	1	1 unit	41C
Short-circuit-proof with B MCB, zero-point switching · Integrated heat sink, rated operational voltage U_e 48 ... 460 V AC						
20	24 DC	5	3RF2320-2DA04	1	1 unit	41C
20	110 ... 230 AC	5	3RF2320-2DA24	1	1 unit	41C

Zero-point switching · Integrated heat sink,
rated operational voltage U_e 24 ... 230 V AC



3RF2320-2

Zero-point switching · Integrated heat sink,
rated operational voltage U_e 48 ... 460 V AC

Zero-point switching · Integrated heat sink,
blocking voltage 1 600 V,
rated operational voltage U_e 48 ... 600 V AC

Low noise²⁾,
zero-point switching · Integrated heat sink,
rated operational voltage U_e 24 ... 230 V AC

Low noise²⁾,
zero-point switching · Integrated heat sink,
rated operational voltage U_e 48 ... 460 V AC

Short-circuit-proof with B MCB,
zero-point switching · Integrated heat sink,
rated operational voltage U_e 24 ... 230 V AC

Short-circuit-proof with B MCB,
zero-point switching · Integrated heat sink,
rated operational voltage U_e 48 ... 460 V AC

¹⁾ The type current provides information about the performance of the solid-state contactor. The actual permitted rated operational current I_e can be smaller depending on the installation conditions. For derating characteristic curves, see page 6/118, "More information".

²⁾ See page 6/133.

Other rated control supply voltages on request.



For accessories, see page 6/143.

Switching devices – Soft starters and solid-state switching devices

Solid-state switching devices for resistive/inductive loads

Solid-state contactors

SIRIUS 3RF23 solid-state contactors, 1-phase

	Type current/ performance capacity ¹⁾ I_{max}	Rated control supply voltage U_s	SD	Ring terminal lug connection	PU (UNIT, SET, M)	PS*	PG			
	A	V	d	Article No.				Price per PU		
Zero-point switching · Integrated heat sink, rated operational voltage U_e 24 ... 230 V AC										
	10.5	24 DC	5	3RF2310-3AA02		1	1 unit	41C		
	20		5	3RF2320-3AA02		1	1 unit	41C		
	30		5	3RF2330-3AA02		1	1 unit	41C		
	40		5	3RF2340-3AA02		1	1 unit	41C		
	50		5	3RF2350-3AA02		1	1 unit	41C		
	70		2	3RF2370-3AA02		1	1 unit	41C		
	10.5	110 ... 230 AC	5	3RF2310-3AA22		1	1 unit	41C		
	20		5	3RF2320-3AA22		1	1 unit	41C		
	30		5	3RF2330-3AA22		1	1 unit	41C		
	40		5	3RF2340-3AA22		1	1 unit	41C		
	50		5	3RF2350-3AA22		1	1 unit	41C		
	70		5	3RF2370-3AA22		1	1 unit	41C		
	Zero-point switching · Integrated heat sink, rated operational voltage U_e 48 ... 460 V AC									
			10.5	24 DC		5	3RF2310-3AA04		1	1 unit
20		5	3RF2320-3AA04		1	1 unit	41C			
30		2	3RF2330-3AA04		1	1 unit	41C			
40		5	3RF2340-3AA04		1	1 unit	41C			
50		2	3RF2350-3AA04		1	1 unit	41C			
70		2	3RF2370-3AA04		1	1 unit	41C			
10.5		110 ... 230 AC	5	3RF2310-3AA24		1	1 unit	41C		
20			5	3RF2320-3AA24		1	1 unit	41C		
30			5	3RF2330-3AA24		1	1 unit	41C		
40			5	3RF2340-3AA24		1	1 unit	41C		
50			5	3RF2350-3AA24		1	1 unit	41C		
70			5	3RF2370-3AA24		1	1 unit	41C		
20			4 ... 30 DC	5		3RF2320-3AA44		1	1 unit	41C
30				5		3RF2330-3AA44		1	1 unit	41C
50		5		3RF2350-3AA44	1	1 unit		41C		
Zero-point switching · Integrated heat sink, rated operational voltage U_e 48 ... 600 V AC										
40		4 ... 30 DC	5	3RF2340-3AA45		1	1 unit	41C		
70			2	3RF2370-3AA45		1	1 unit	41C		
Zero-point switching · Integrated heat sink, blocking voltage 1 600 V, rated operational voltage U_e 48 ... 600 V AC										
	10.5	24 DC	5	3RF2310-3AA06		1	1 unit	41C		
	20		5	3RF2320-3AA06		1	1 unit	41C		
	30		5	3RF2330-3AA06		1	1 unit	41C		
	40		5	3RF2340-3AA06		1	1 unit	41C		
	50		5	3RF2350-3AA06		1	1 unit	41C		
	70		5	3RF2370-3AA06		1	1 unit	41C		
	10.5	110 ... 230 AC	5	3RF2310-3AA26		1	1 unit	41C		
	20		5	3RF2320-3AA26		1	1 unit	41C		
	30		5	3RF2330-3AA26		1	1 unit	41C		
	40		5	3RF2340-3AA26		1	1 unit	41C		
	50		5	3RF2350-3AA26		1	1 unit	41C		
	70		5	3RF2370-3AA26		1	1 unit	41C		

¹⁾ The type current provides information about the performance of the solid-state contactor. The actual permitted rated operational current I_e can be smaller depending on the installation conditions. For derating characteristic curves, see page 6/118, "More information".

Other rated control supply voltages on request.



For accessories, see page 6/143.

Switching devices – Soft starters and solid-state switching devices

Solid-state switching devices for resistive/inductive loads

Solid-state contactors

SIRIUS 3RF23 solid-state contactors, 1-phase

Type current/ performance capacity ¹⁾ I_{max}	Operational current I_e / AC-15 ²⁾	Rated control supply voltage U_s	SD	Ring terminal lug connection	PU (UNIT, SET, M)	PS*	PG
A	A	V	d	Article No.	Price per PU		
Instantaneous switching · Integrated heat sink, rated operational voltage U_e 24 ... 230 V AC							
	70	27.5	24 DC	5	3RF2370-3BA02	1	1 unit 41C
	70	27.5	110 ... 230 AC	5	3RF2370-3BA22	1	1 unit 41C
Instantaneous switching · Integrated heat sink, rated operational voltage U_e 48 ... 460 V AC							
	70	27.5	24 DC	5	3RF2370-3BA04	1	1 unit 41C
	70	27.5	110 ... 230 AC	5	3RF2370-3BA24	1	1 unit 41C
Instantaneous switching · Integrated heat sink, blocking voltage 1 600 V, rated operational voltage U_e 48 ... 600 V AC							
	70	27.5	24 DC	5	3RF2370-3BA06	1	1 unit 41C
	70	27.5	110 ... 230 AC	5	3RF2370-3BA26	1	1 unit 41C
Short-circuit-proof with B MCB, zero-point switching · Integrated heat sink, rated operational voltage U_e 24 ... 230 V AC							
	20	--	24 DC	5	3RF2320-3DA02	1	1 unit 41C
	20	--	110 ... 230 AC	5	3RF2320-3DA22	1	1 unit 41C
Short-circuit-proof with B MCB, zero-point switching · Integrated heat sink, rated operational voltage U_e 48 ... 460 V AC							
	20	--	24 DC	5	3RF2320-3DA04	1	1 unit 41C
	20	--	110 ... 230 AC	5	3RF2320-3DA24	1	1 unit 41C

¹⁾ The type current provides information about the performance of the solid-state contactor. The actual permitted rated operational current I_e can be smaller depending on the installation conditions. For derating characteristic curves, see page 6/118, "More information".

²⁾ Utilization category AC-15:
Electromagnetic loads, e.g. valves according to IEC 60947-5-1.
Parameters: max. 1 200 1/h, 50% ON period, 10-times inrush current for 60 ms.

Other rated control supply voltages on request.

For accessories, see page 6/143.





Switching devices – Soft starters and solid-state switching devices

Solid-state switching devices for resistive/inductive loads

Solid-state contactors

SIRIUS 3RF23 solid-state contactors, 1-phase

Accessories

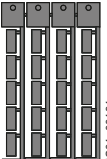
Version	SD	Article No.	Price per PU	PU (UNIT, SET, M)	PS*	PG
Terminal covers						
		Ring terminal lug connection 3RF2900-3PA88		1	10 units	41C
3RF2900-3PA88	15					
Control connectors						
		Replacement control connectors For 3RF23 and 3RF24 solid-state contactors with screw terminals		1	50 units	41C
3RF2900-1TA88	5					
		Replacement control connectors For 3RF23 and 3RF24 solid-state contactors with spring-loaded terminals		1	50 units	41C
3RF2900-2TA88	5					
		Control connectors For 3RF23 and 3RF24 solid-state contactors Spring-loaded terminals with two clamping points per contact		1	10 units	41C
3RF2900-2TB88	5					
Tools for opening spring-loaded terminals						
		Screwdrivers For all SIRIUS devices with spring-loaded terminals Length approx. 200 mm, size 3.0 mm x 0.5 mm, titanium gray/black, partially insulated		1	1 unit	41B
3RA2908-1A	2					
Blank labels						
		Unit labeling plates For SIRIUS devices ¹⁾ 20 mm x 7 mm, titanium gray		100	340 units	41B
3RT2900-1SB20	20					
		Adhesive labels For SIRIUS devices 19 mm x 6 mm, titanium gray		100	3060 units	41B
3RT2900-1SB60	5					

¹⁾ PC labeling systems for individual inscription of unit labeling plates available from: murrplastik Systemtechnik GmbH (see page 16/16).

Switching devices – Soft starters and solid-state switching devices

Solid-state switching devices for resistive/inductive loads

Solid-state contactors

SIRIUS 3RF24 solid-state contactors, 3-phase

Overview

3-phase solid-state contactors with heat sink

Their compact design with optimized heat sink enables small complete units with currents up to 50 A. They also offer all the



special features of the solid-state relay in terms of time and space savings.

Technical specifications

More information

System Manual for modular system, see <https://support.industry.siemens.com/cs/ww/en/view/60311318>

FAQs, see <https://support.industry.siemens.com/cs/ww/en/ps/16223/faq>

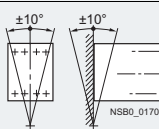
Type	3RF24..-1....	3RF24..-2....	3RF24..-3....
Dimensions (W x H x D)	See page 6/145		
General data			
Ambient temperature			
• During operation, derating from 40 °C	°C	-25 ... +60	
• During storage	°C	-55 ... +80	
Installation altitude	m	0 ... 1 000; derating from 1 000	
Shock resistance acc. to IEC 60068-2-27	g/ms	15/11	
Vibration resistance acc. to IEC 60068-2-6	g	2	
Degree of protection IP on the front acc. to IEC 60529		IP20	IP00
Touch protection on the front acc. to IEC 60529		Finger-safe for vertical touching from the front	
Insulation strength at 50/60 Hz (main/control circuit to floor)	V rms	4 000	
Electromagnetic compatibility (EMC)			
• Emitted interference according to IEC 60947-4-3 - Conducted interference voltage		Class A for industrial applications ¹⁾	
• Interference immunity - Electrostatic discharge acc. to IEC 61000-4-2 (corresponds to degree of severity 3)	kV	Contact discharge 4; air discharge 8; behavior criterion 2	
- Induced RF fields acc. to IEC 61000-4-6	MHz	0.15 ... 80; 140 dBµV; behavior criterion 1	
- Burst acc. to IEC 61000-4-4	kV	2/5.0 kHz; behavior criterion 2	
- Surge acc. to IEC 61000-4-5	kV	Conductor - ground 2; conductor - conductor 1; behavior criterion 2	
Connection type			
Connection, main contacts			
• Conductor cross-section	mm ²	2 x (1.5 ... 2.5) ²⁾ , 2 x (2.5 ... 6) ²⁾	2 x (0.5 ... 2.5)
- Solid	mm ²	2 x (1 ... 2.5) ²⁾ , 2 x (2.5 ... 6) ²⁾ , 1 x 10	2 x (0.5 ... 1.5)
- Finely stranded with end sleeve	mm ²	--	--
- Finely stranded without end sleeve	mm ²	--	2 x (0.5 ... 2.5)
- Solid or stranded, AWG cables	AWG	2 x (14 ... 10)	2 x (18 ... 14)
• Stripped length	mm	10	10
• Terminal screws		M4	M5
- Tightening torque	Nm	2 ... 2.5	2 ... 2.5
	lb.in	18 ... 22	18 ... 22
• Cable lugs		--	5-2.5 ... 5-25
- According to DIN 46234		--	R 2-5 ... R 14-5
- According to JIS C 2805		--	12
- Width, maximum	mm	--	--
Connection, auxiliary/control contacts			
• Conductor cross-section	mm	1 x (0.5 ... 2.5), 2 x (0.5 ... 1.0)	1 x (0.5 ... 2.5), 2 x (0.5 ... 1.0)
	AWG	20 ... 12	20 ... 12
• Stripped length	mm	7	7
• Terminal screw		M3	M3
- Tightening torque,	Nm	0.5 ... 0.6	0.5 ... 0.6
∅ 3.5 mm, PZ 1	lb.in	4.5 ... 5.3	4.5 ... 5.3
Grounding studs		Optional, see also note on page 6/133 about the special mounting foot for safe grounding on standard mounting rails	
• Size (standard screw)		M5	
Permissible mounting position			

¹⁾ These products were built as Class A devices. The use of these devices in residential areas could result in radio interference. In this case it may be required to introduce additional interference suppression measures. The versions 3RF24..-1AC55 comply with Class B for residential, business and commercial applications.

²⁾ If two different conductor cross-sections are connected to one clamping point, both cross-sections must lie in one of the ranges specified.

Switching devices – Soft starters and solid-state switching devices

Solid-state switching devices for resistive/inductive loads

Solid-state contactors

SIRIUS 3RF24 solid-state contactors, 3-phase

Type	Type current/ performance capacity ¹⁾	Rated operational current I_e		Power loss at I_{AC-51}	Minimum load current	Max. off-state current	Rated peak withstand current I_{tsm}	I^2t value
	I_{AC-51} at 40 °C	Acc. to IEC 60947-4-3 at 40 °C	Acc. to UL/CSA at 50 °C					
Main circuit								
3RF2410-AB.5	10.5	7	7	23	0.1	10	200	200
3RF2420-AB.5	22	15	15	44	0.5	10	600	1 800
3RF2430-AB.5	30	22	22	61	0.5	10	1 200	7 200
3RF2440-AB.5	40	30	30	80	0.5	10	1 150	6 600
3RF2450-AB.5	50	38	38	107	0.5	10	1 150	6 600
3RF2410-AC.5	10.5	7	7	31	0.5	10	300	450
3RF2420-AC.5	22	15	15	66	0.5	10	600	1 800
3RF2430-AC.5	30	22	22	91	0.5	10	1 200	7 200
3RF2440-AC.5	40	30	30	121	0.5	10	1 150	6 600
3RF2450-AC.5	50	38	38	160	0.5	10	1 150	6 600

¹⁾ The type current provides information about the performance of the solid-state contactor. The actual permitted rated operational current I_e can be smaller depending on the connection method and installation conditions.

Type	Type current I_{AC-51}	Dimensions (W x H x D) (including heat sink)
	A	mm

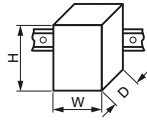

Main circuit		
3RF2410-AB..	10.5	45 x 95 x 92.5
3RF2410-AC..		
3RF2420-AB..	22	45 x 95 x 109.5
3RF2420-AC..	22	74.5 x 95 x 112
3RF2430-AB..	30	

Type	Type current I_{AC-51}	Dimensions (W x H x D) (including heat sink)
	A	mm

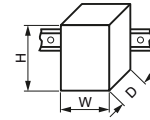

Main circuit		
3RF2430-AC..	30	89.5 x 95 x 120.5
3RF2440-AB..	40	
3RF2440-AC..	40	119.5 x 95 x 130.5
3RF2450-AB..	50	
3RF2450-AC..	50	119.5 x 150 x 130.5

Type	3RF24...-AB.5		3RF24...-AC.5	
Main circuit				
Controlled phases		2-phase		3-phase
Rated operational voltage U_e	V AC	48 ... 600		
• Operating range	V AC	40 ... 660		
• Rated frequency	Hz	50/60 ± 10%		
Rated insulation voltage U_i	V	600		
Rated impulse withstand voltage U_{imp}	kV	6		
Blocking voltage	V	1 200		
Rate of voltage rise	V/μs	1 000		

Type	3RF24...-...3.		3RF24...-...4.		3RF24...-...5.	
Control circuit						
Method of operation		AC operation		DC operation		AC operation
Rated control supply voltage U_s	V	110		4 ... 30		190 ... 230
Rated frequency of the control supply voltage	Hz	50/60 ± 10%		--		50/60 ± 10%
Actuating voltage, max.	V	121		30		253
Typical actuating current	mA	15		30		15
Response voltage	V	90		4		180
Drop-out voltage	V	< 40		< 1		< 40
Operating times						
• ON-delay	ms	40 + max. one half-wave		1 + max. one half-wave		40 + max. one half-wave
• OFF-delay	ms	40 + max. one half-wave		1 + max. one half-wave		40 + max. one half-wave





Switching devices – Soft starters and solid-state switching devices

Solid-state switching devices for resistive/inductive loads

Solid-state contactors

SIRIUS 3RF24 solid-state contactors, 3-phase

Selection and ordering data

Type current/ performance capacity ¹⁾ I_{max}	Rated control supply voltage U_s	SD	Screw terminals	⊕	PU (UNIT, SET, M)	PS*	PG
A	V	d	Article No.		Price per PU		
Zero-point switching · Integrated heat sink, rated operational voltage U_e 48 ... 600 V AC							
2-phase controlled							
 3RF2410-1AB45	10.5	4 ... 30 DC	2	3RF2410-1AB45	1	1 unit	41C
	20		2	3RF2420-1AB45	1	1 unit	41C
	30		2	3RF2430-1AB45	1	1 unit	41C
	40		5	3RF2440-1AB45	1	1 unit	41C
	50		2	3RF2450-1AB45	1	1 unit	41C
 3RF2420-1AB45	10.5	110 AC	5	3RF2410-1AB35	1	1 unit	41C
	20		5	3RF2420-1AB35	1	1 unit	41C
	30		5	3RF2430-1AB35	1	1 unit	41C
	40		5	3RF2440-1AB35	1	1 unit	41C
	50		5	3RF2450-1AB35	1	1 unit	41C
 3RF2410-1AB55	10.5	230 AC	5	3RF2410-1AB55	1	1 unit	41C
	20		5	3RF2420-1AB55	1	1 unit	41C
	30		5	3RF2430-1AB55	1	1 unit	41C
	40		5	3RF2440-1AB55	1	1 unit	41C
	50		5	3RF2450-1AB55	1	1 unit	41C
3-phase controlled							
 3RF2410-1AC45	10.5	4 ... 30 DC	2	3RF2410-1AC45	1	1 unit	41C
	20		2	3RF2420-1AC45	1	1 unit	41C
	30		2	3RF2430-1AC45	1	1 unit	41C
	40		2	3RF2440-1AC45	1	1 unit	41C
	50		2	3RF2450-1AC45	1	1 unit	41C
	10.5	110 AC	5	3RF2410-1AC35	1	1 unit	41C
	20		5	3RF2420-1AC35	1	1 unit	41C
	30		5	3RF2430-1AC35	1	1 unit	41C
	40		5	3RF2440-1AC35	1	1 unit	41C
	50		5	3RF2450-1AC35	1	1 unit	41C
	10.5	230 AC	5	3RF2410-1AC55	1	1 unit	41C
	20		5	3RF2420-1AC55	1	1 unit	41C
	30		5	3RF2430-1AC55	1	1 unit	41C
	40		5	3RF2440-1AC55	1	1 unit	41C
	50		5	3RF2450-1AC55	1	1 unit	41C

¹⁾ The type current provides information about the performance of the solid-state contactor. The actual permitted rated operational current I_e can be smaller depending on the connection method and installation conditions. For derating characteristic curves, see page 6/118, "More information".

For accessories, see page 6/143.

Switching devices – Soft starters and solid-state switching devices

Solid-state switching devices for resistive/inductive loads

Solid-state contactors

SIRIUS 3RF24 solid-state contactors, 3-phase

Type current/ performance capacity ¹⁾ I_{max}	Rated control supply voltage U_s	SD	Spring-loaded terminals	PU (UNIT, SET, M)	PS*	PG
A	V	d	Article No.	Price per PU		

Zero-point switching · Integrated heat sink,
rated operational voltage U_e 48 ... 600 V AC



3RF2410-2AB45

2-phase controlled						
10	4 ... 30 DC	5	3RF2410-2AB45	1	1 unit	41C
20		5	3RF2420-2AB45	1	1 unit	41C
10	230 AC	5	3RF2410-2AB55	1	1 unit	41C
20		5	3RF2420-2AB55	1	1 unit	41C
3-phase controlled						
10	4 ... 30 DC	5	3RF2410-2AC45	1	1 unit	41C
20		5	3RF2420-2AC45	1	1 unit	41C
10	230 AC	5	3RF2410-2AC55	1	1 unit	41C
20		5	3RF2420-2AC55	1	1 unit	41C

¹⁾ The type current provides information about the performance of the solid-state contactor. The actual permitted rated operational current I_e can be smaller depending on the connection method and installation conditions. For derating characteristic curves, see page 6/118, "More information".

For accessories, see page 6/143.

Type current/ performance capacity ¹⁾ I_{max}	Rated control supply voltage U_s	SD	Ring terminal lug connection	PU (UNIT, SET, M)	PS*	PG
A	V	d	Article No.	Price per PU		

Zero-point switching · Integrated heat sink,
rated operational voltage U_e 48 ... 600 V AC

2-phase controlled						
50	4 ... 30 DC	5	3RF2450-3AB45	1	1 unit	41C
50	230 AC	5	3RF2450-3AB55	1	1 unit	41C
3-phase controlled						
50	4 ... 30 DC	5	3RF2450-3AC45	1	1 unit	41C
50	230 AC	5	3RF2450-3AC55	1	1 unit	41C

¹⁾ The type current provides information about the performance of the solid-state contactor. The actual permitted rated operational current I_e can be smaller depending on the connection method and installation conditions. For derating characteristic curves, see page 6/118, "More information".

For accessories, see page 6/143.

Switching devices – Soft starters and solid-state switching devices

Solid-state switching devices for resistive/inductive loads

Function modules

General data

Overview

Function modules for SIRIUS 3RF2 solid-state switching devices

A great variety of applications demand an expanded range of functionality. With our function modules, these requirements can be met really easily. The modules are mounted simply by clicking them into place; straight away the necessary connections are made with the solid-state relay or contactor.

The plug-in connection to control the solid-state switching devices can simply remain in use. The external connections have screw terminals.

For function modules with current measurement, the load cable must be inserted through the straight-through transformer and reconnected to the solid-state switching device.

The following function modules are available:

- Converters (without current measurement)
- Load monitoring
- Heating current monitoring
- Power controllers
- Power regulators

For recommended assignment of the function modules to 3RF2 solid-state switching devices, see [Industry Mall](#).

With the exception of the converter, the function modules can be used only with 1-phase solid-state switching devices.

Technical specifications

More information

System Manual for modular system, see <https://support.industry.siemens.com/cs/ww/en/view/60311318>

FAQs, see <https://support.industry.siemens.com/cs/ww/en/ps/16231/faq>

Type		3RF29..-0EA..	3RF29..-0FA..	3RF29..-0GA..	3RF29..-0HA..	3RF29..-0JA..	3RF29..-0KA..
Dimensions (W x H x D)	mm	22.5 x 84 x 38	22.5 x 102 x 39	45 x 112 x 44	45 x 112 x 44	45 x 112 x 44	45 x 112 x 44

General data

Ambient temperature

- During operation, derating from 40 °C
- During storage

°C -25 ... +60
°C -55 ... +80

Installation altitude m 0 ... 1 000; derating from 1 000

Shock resistance acc. to IEC 60068-2-27 g/ms 15/11

Vibration resistance acc. to IEC 60068-2-6 g 2

Degree of protection IP on the front acc. to IEC 60529 IP20

Touch protection on the front acc. to IEC 60529 Finger-safe for vertical touching from the front

Electromagnetic compatibility (EMC)

- Emitted interference
 - Conducted interference voltage acc. to IEC 60947-4-3 Class A for industrial applications¹⁾
 - Emitted, high-frequency interference voltage acc. to IEC 60947-4-3 Class B for residential, business and commercial applications
- Interference immunity
 - Electrostatic discharge acc. to IEC 61000-4-2 (corresponds to degree of severity 3) kV Contact discharge 4; air discharge 8; behavior criterion 2
 - Induced RF fields acc. to IEC 61000-4-6 MHz 0.15 ... 80; 140 dB μ V; behavior criterion 1
 - Burst acc. to IEC 61000-4-4 2 kV/5.0 kHz; behavior criterion 2
 - Surge acc. to IEC 61000-4-5 kV Conductor - ground 2; conductor - conductor 1; behavior criterion 2

Connection type

Auxiliary/control contacts

- Conductor cross-section mm² 1 x (0.5 ... 2.5), 2 x (0.5 ... 1.0), 1 x (AWG 20 ... 12)
- Stripped length mm 7
- Terminal screw M3
- Tightening torque Nm 0.5 ... 0.6
- lb.in 4.5 ... 5.3

Connection type

Converters

- Diameter mm -- 7 17

¹⁾ Note limitations for power controller and power regulator function modules. These modules were built as Class A devices. The use of these devices in residential areas could result in radio interference. In this case it may be required to introduce additional interference suppression measures.

Switching devices – Soft starters and solid-state switching devices

Solid-state switching devices for resistive/inductive loads

Function modules

General data

Type		3RF29...-0EA18	3RF29...-0FA08	3RF29...-0GA.3	3RF29...-0GA.6
Main circuit					
Rated operational voltage U_e	V AC	-- ¹⁾		110 ... 230	400 ... 600
• Operating range	V AC	--		93.5 ... 253	340 ... 660
• Rated frequency	Hz	--		50/60	
Rated insulation voltage U_i	V	--		600	
Voltage measuring					
• Measuring range	V	--		93.5 ... 253	340 ... 660
Mains voltage, fluctuation compensation	%	--		20	

¹⁾ Versions are independent of the main circuit.

Type		3RF29...-0HA.3 3RF29...-0KA.3	3RF29...-0HA.6 3RF29...-0KA.6	3RF29...-0JA.3	3RF29...-0JA.6
Main circuit					
Rated operational voltage U_e	V AC	110 ... 230	400 ... 600	110 ... 230	400 ... 600
• Operating range	V AC	93.5 ... 253	340 ... 660	93.5 ... 253	340 ... 660
• Rated frequency	Hz	50/60			
Rated insulation voltage U_i	V	600			
Voltage measuring					
• Measuring range	V	93.5 ... 253	340 ... 660	93.5 ... 253	340 ... 660
Mains voltage, fluctuation compensation	%	20			

Type		3RF29...-...0.	3RF29...-...1.
Control circuit			
Method of operation		DC operation	AC/DC operation
Rated control supply voltage U_s	V	24	
Rated actuating current	mA	25	40
Rated frequency	Hz	--	50/60
of the control supply voltage			
Actuating voltage, max.	V	30	
Rated actuating current	mA	30	50
At maximum voltage			
Response voltage	V	15	
• For operating current	mA	2	
Drop-out voltage	V	5	

Type		3RF2906-0FA08	3RF2920-0FA08	3RF2920-0GA..	3RF2950-0GA..	3RF2990-0GA..
Current measurement						
Rated operational current I_e	A	6	20		50	90
Current measurement						
• Teach range	A	0.25 ... 6	0.65 ... 20	0.56 ... 20	1.62 ... 50	2.93 ... 90
• Measuring range	A	0 ... 6.6	0 ... 22		0 ... 55	0 ... 99
• Minimum partial load current	A	0.25	0.65		1.6	2.9
Number of partial loads		1 ... 6		1 ... 12		

Type		3RF2920-0HA..	3RF2950-0HA..	3RF2990-0HA..	3RF2916-0JA..	3RF2932-0JA..
Current measurement						
Rated operational current I_e	A	20	50	90	16	32
Current measurement						
• Teach range	A	4 ... 20	10 ... 50	18 ... 90	0.42 ... 16	0.8 ... 32
• Measuring range	A	0 ... 22	0 ... 55	4 ... 99	0 ... 16	0 ... 32
• Minimum partial load current	A	--			0.42	0.8
Number of partial loads		--			1 ... 6	

Type		3RF2904-0KA..	3RF2920-0KA..	3RF2950-0KA..	3RF2990-0KA..
Current measurement					
Rated operational current I_e	A	4	20	50	90
Current measurement					
• Teach range	A	0.15 ... 4	0.65 ... 20	1.6 ... 50	2.9 ... 90
• Measuring range	A	0 ... 4	0 ... 22	0 ... 55	0 ... 99
• Minimum partial load current	A	--	0.65	1.6	2.9
Number of partial loads		--	1 ... 6		

Switching devices – Soft starters and solid-state switching devices

Solid-state switching devices for resistive/inductive loads

Function modules

SIRIUS converters for 3RF2

Overview

Converters for 3RF2 solid-state switching devices

These modules are used to convert analog control signals, such as those output from many temperature controllers for example, into a pulse-width-modulated digital signal. The connected solid-state contactors and relays can therefore regulate the output of a load as a percentage.

Application

This function module is used for conversions from an analog input signal to an on/off ratio with time basis 1 s. The module can only be used in conjunction with 3RF21 and 3RF23 1-phase solid-state switching devices or 3RF22 and 3RF24 3-phase devices. It can be used on versions with 24 V DC and 24 V AC/DC control supply voltage.

Note:

The use of 1-pole solid-state switching devices with converters, power controllers or power regulators in three-phase networks in full-wave control mode is not recommended. Since the function modules do not synchronize with each other, this may lead to fluctuations in the heating power; optimum compensation can no longer be ensured, especially for setpoints < 50%.

Selection and ordering data

Converters	Rated operational current I_e	Rated operational voltage U_e	SD	Screw terminals	⊕	PU (UNIT, SET, M)	PS*	PG
	A	V	d	Article No.	Price per PU			
 3RF2900-0EA18	Rated control supply voltage 24 V AC/DC	--	--	2	3RF2900-0EA18	1	1 unit	41C

Accessories

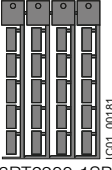
Blank labels	Version	SD	Article No.	Price per PU	PU (UNIT, SET, M)	PS*	PG
 3RT2900-1SB20	Unit labeling plates For SIRIUS devices ¹⁾ 20 mm × 7 mm, titanium gray	20	3RT2900-1SB20	100	340 units	41B	
	Adhesive labels For SIRIUS devices 19 mm × 6 mm, titanium gray	5	3RT2900-1SB60	100	3060 units	41B	

¹⁾ PC labeling systems for individual inscription of unit labeling plates are available from: murrplastik Systemtechnik GmbH (see page 16/16).

Switching devices – Soft starters and solid-state switching devices

Solid-state switching devices for resistive/inductive loads

Function modules

SIRIUS load monitoring for 3RF2

Overview

Load monitoring for 3RF2 1-phase solid-state switching devices

Many faults can be quickly detected by monitoring a load circuit connected to the solid-state switching device, as made possible with this module. Examples include the failure of load elements (up to 6 in the basic version or up to 12 in the extended version), alloyed power semiconductors, a lack of voltage or a break in a load circuit. A fault is indicated by one or more LEDs and reported to the controller by way of a PLC-compatible output.

The principle of operation is based on permanent monitoring of the current intensity. This figure is continuously compared with the reference value stored once during startup by the simple press of a button. In order to detect the failure of one of several loads, the current difference must be 1/6 (in the basic version) or 1/12 (in the extended version) of the reference value. In the event of a fault, an output is actuated and one or more LEDs indicate the fault.

Application

The device is used for monitoring one or more loads (partial loads).

Notes:

The function module can only be used in conjunction with a 3RF21 solid-state relay or a 3RF23 solid-state contactor.

The solid-state switching devices with spring-loaded terminals in the load circuit are not suitable for load monitoring!

Selection and ordering data

Rated operational current I_e	Rated operational voltage U_e	SD	Screw terminals	⊕	PU (UNIT, SET, M)	PS*	PG
A	V	d	Article No.	Price per PU			
Basic load monitoring							
Rated control supply voltage 24 V DC							
6	--	2	3RF2906-0FA08		1	1 unit	41C
20	--	2	3RF2920-0FA08		1	1 unit	41C
• With mounted 3RF2900-ORA88 cover							
6	--	2	3RF2906-0FA08-0KH0		1	1 unit	41C
20	--	2	3RF2920-0FA08-0KH0		1	1 unit	41C
Extended load monitoring							
Rated control supply voltage 24 V AC/DC							
20	110 ... 230	2	3RF2920-0GA13		1	1 unit	41C
20	400 ... 600	2	3RF2920-0GA16		1	1 unit	41C
50	110 ... 230	2	3RF2950-0GA13		1	1 unit	41C
50	400 ... 600	2	3RF2950-0GA16		1	1 unit	41C
90	110 ... 230	2	3RF2990-0GA13		1	1 unit	41C
90	400 ... 600	2	3RF2990-0GA16		1	1 unit	41C



3RF2920-0FA08



3RF2920-0GA13

Accessories

Version	SD	Article No.	Price per PU	PU (UNIT, SET, M)	PS*	PG
	d					
Covers						
Sealable covers for function modules (not for converters)	5	3RF2900-ORA88		1	10 units	41C
For securing against unauthorized adjustment of setting knobs						
Blank labels						
Unit labeling plates For SIRIUS devices ¹⁾	20	3RT2900-1SB20		100	340 units	41B
20 mm × 7 mm, titanium gray						
Adhesive labels For SIRIUS devices	5	3RT2900-1SB60		100	3060 units	41B
19 mm × 6 mm, titanium gray						

3RF2900-ORA88

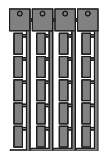

3RT2900-1SB20

¹⁾ PC labeling systems for individual inscription of unit labeling plates are available from: murrplastik Systemtechnik GmbH (see page 16/16).

Switching devices – Soft starters and solid-state switching devices

Solid-state switching devices for resistive/inductive loads

Function modules

SIRIUS heating current monitoring for 3RF2

Overview

Heating current monitoring for 3RF2 1-phase solid-state switching devices

Many faults can be quickly detected by monitoring a load circuit connected to the solid-state switching device, as made possible with this module. Examples include the failure of up to six load elements, alloyed power semiconductors, a lack of voltage, or a break in the load circuit. A fault is indicated by LEDs and reported to the controller via relay output (NC).

The principle of operation is based on permanent monitoring of the current intensity. This figure is continuously compared with the reference value stored once during startup. In order to detect the failure of one of several loads, the current difference must be 1/6 of the reference value. In the event of a fault, an output is actuated and the LEDs indicate the fault.

The heating current monitoring has a teach input and therefore differs from the load monitoring. This remote teaching function enables simple adjustment to changing loads without manual intervention.

Special version:

Deviations from the standard version

3RF29...-0JA1.-1KK0

If the current is below 50% of the lower teach current during the teach routine, the device will go into "Standby" mode; the LOAD LED will flicker. The device thus detects a non-connected load, e.g. channels not required for tool heaters, and does not signal a fault. This mode can be reset by re-teaching.

Application

The device is used for monitoring one or more loads (partial loads).

Notes:

The function module can only be used in conjunction with a 3RF21 solid-state relay or a 3RF23 solid-state contactor.

The solid-state switching devices with spring-loaded terminals in the load circuit are not suitable!

Selection and ordering data

Rated operational current I_e	Rated operational voltage U_e	SD	Screw terminals	PU (UNIT, SET, M)	PS*	PG
A	V	d	Article No.	Price per PU		
Heating current monitoring¹⁾						
Rated control supply voltage 24 V AC/DC						
16	110 ... 230	2	3RF2916-0JA13	1	1 unit	41C
16	110 ... 230	2	3RF2916-0JA13-1KK0	1	1 unit	41C
16	400 ... 600	2	3RF2916-0JA16-1KK0	1	1 unit	41C
32	110 ... 230	2	3RF2932-0JA13-1KK0	1	1 unit	41C
32	400 ... 600	2	3RF2932-0JA16	1	1 unit	41C
32	400 ... 600	2	3RF2932-0JA16-1KK0	1	1 unit	41C



3RF2916-0JA13

¹⁾ Supplied without control connector. The control connector can be purchased from Wieland by quoting Article No. 8213 B/6VR (PCB connector), see page 16/16.

Accessories

Version	SD	Article No.	Price per PU	PU (UNIT, SET, M)	PS*	PG
	d					
Covers						
Sealable covers for function modules (not for converters) For securing against unauthorized adjustment of setting knobs	5	3RF2900-ORA88		1	10 units	41C
Blank labels						
Unit labeling plates For SIRIUS devices ¹⁾ 20 mm × 7 mm, titanium gray	20	3RT2900-1SB20		100	340 units	41B
Adhesive labels For SIRIUS devices 19 mm × 6 mm, titanium gray	5	3RT2900-1SB60		100	3060 units	41B



3RF2900-ORA88

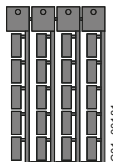

3RT2900-1SB20

¹⁾ PC labeling systems for individual inscription of unit labeling plates are available from: murrplastik Systemtechnik GmbH (see page 16/16).

Switching devices – Soft starters and solid-state switching devices

Solid-state switching devices for resistive/inductive loads

Function modules

SIRIUS power controllers for 3RF2

Overview

Power controllers for 3RF2 1-phase solid-state switching devices

The power controller is a function module for the autonomous power control of complex heating systems and inductive loads. The following functions have been integrated:

- **Power controller**
For adjusting the power of the connected load. The setpoint value is selected via a rotary knob on the module as a percentage of the 100% power value stored.
- **Inrush current limiting**
With the aid of an adjustable voltage ramp, the inrush current is limited by means of phase control. This is useful above all with loads such as lamps or infrared lamps which have an inrush transient current.
- **Load circuit monitoring**
For detecting load failure, partial load faults, alloyed power semiconductors, lack of voltage or a break in the load circuit.

Note:

With the phase control operating mode, a partial load fault is detected by cyclic "scanning" of the load; the exact mode of operation is described in the data sheets!

Special version: Deviations from the standard version

3RF2904-0KA13-0KC0

During the teach routine, the connected solid-state relay or contactor is not activated; i.e. no current will flow. No current reference value is stored. No partial load monitoring!

3RF29..-0KA1.-0KTO

No partial load monitoring!

Application

The power controller can be used for:

- Complex heating systems
- Inductive loads
- Loads with temperature-dependent resistor
- Loads with ageing after long-time service
- Simple indirect control of temperature

Notes:

This function module can only be used in conjunction with a 3RF21 solid-state relay or a 3RF23 solid-state contactor.

The solid-state switching devices with spring-loaded terminals in the load circuit are not suitable!

Power control

The power controller adjusts the power in the connected load by means of a solid-state switching device depending on the setpoint selection. It does not compensate for changes in the mains voltage or load resistance. The setpoint value can be predefined externally as a 0 to 10 V signal or internally by means of a potentiometer. Depending on the setting of the potentiometer (t_P), the control is carried out according to the principle of full-wave control or generalized phase control.

Note:

In the case of ohmic loads, the power is set linear to the setpoint value. During operation of inductive loads, the power control is no longer proportional and linear due to the phase shift between current and voltage.

Full-wave control

In this operating mode the output is adjusted to the required setpoint value by changing the on-to-off period. The period duration is predefined at 1 s.

Notes:

The use of 1-pole solid-state switching devices with converters, power controllers or power regulators in three-phase networks in full-wave control mode is not recommended. Since the function modules do not synchronize with each other, this may lead to fluctuations in the heating power; optimum compensation can no longer be ensured, especially for setpoints < 50%.

Generalized phase control

In this operating mode the output is adjusted to the required setpoint value by changing the current flow angle. In order to observe the limit values of the conducted interference voltage for industrial networks, at loads up to 20 kVA, the load circuit must include an additional filter, and for loads above 20 kVA, a reactor with a rating of at least 200 μ H must be used. You will find details about the filters in the FAQ "Filters for 3RF29 power regulators and power controllers to comply with the limits for electromagnetic emitted interference", see <https://support.industry.siemens.com/cs/ww/en/view/109751887>.

Switching devices – Soft starters and solid-state switching devices

Solid-state switching devices for resistive/inductive loads

Function modules

SIRIUS power controllers for 3RF2

Selection and ordering data

Rated operational current I_e	Rated operational voltage U_e	SD	Screw terminals 	PU (UNIT, SET, M)	PS*	PG
A	V	d				
Power controllers						
Rated control supply voltage 24 V AC/DC						
4	110 ... 230	2	3RF2904-0KA13-0KC0	1	1 unit	41C
4		2	3RF2904-0KA13-0KT0	1	1 unit	41C
20		2	3RF2920-0KA13	1	1 unit	41C
50	400 ... 600	2	3RF2950-0KA13	1	1 unit	41C
90		2	3RF2990-0KA13	1	1 unit	41C
20		2	3RF2920-0KA16	1	1 unit	41C
50	400 ... 600	2	3RF2950-0KA16	1	1 unit	41C
50		2	3RF2950-0KA16-0KT0	1	1 unit	41C
90		2	3RF2990-0KA16	1	1 unit	41C



3RF2904-0KA13

Accessories

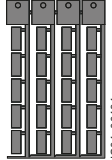
Version	SD	Article No.	Price per PU	PU (UNIT, SET, M)	PS*	PG	
	d						
Covers							
		Sealable covers for function modules (not for converters)	5	3RF2900-0RA88	1	10 units	41C
For securing against unauthorized adjustment of setting knobs							
Blank labels							
		Unit labeling plates For SIRIUS devices ¹⁾	20	3RT2900-1SB20	100	340 units	41B
20 mm × 7 mm, titanium gray							
		Adhesive labels For SIRIUS devices	5	3RT2900-1SB60	100	3060 units	41B
19 mm × 6 mm, titanium gray							

3RF2900-0RA88

3RT2900-1SB20

¹⁾ PC labeling systems for individual inscription of unit labeling plates are available from: murrplastik Systemtechnik GmbH (see page 16/16).

Switching devices – Soft starters and solid-state switching devices

Solid-state switching devices for resistive/inductive loads

Function modules

SIRIUS power regulators for 3RF2

Overview

Power regulators for 3RF2 1-phase solid-state switching devices

The power regulator is a function module for the autonomous power control of complex heating systems.

The following functions have been integrated:

- **Power controller with proportional-action control**
For adjusting the power of the connected load. The setpoint value is selected via a rotary knob on the module as a percentage of the 100% power value stored. Changes in the mains voltage or in the load resistance are compensated in this case.
- **Inrush current limiting**
With the aid of an adjustable voltage ramp, the inrush current is limited by means of phase control. This is useful above all with loads such as lamps which have an inrush transient current.
- **Load circuit monitoring**
For detecting load failure, alloyed power semiconductors, lack of voltage or a break in the load circuit. Partial load monitoring is not possible. Load fluctuations are compensated.

Application

The power regulator can be used for:

- Complex heating systems
- Heating elements with temperature-dependent resistor
- Heating elements with ageing after long-time service
- Simple indirect control of temperature

Notes:

This function module can only be used in conjunction with a 3RF21 solid-state relay or a 3RF23 solid-state contactor.

The solid-state switching devices with spring-loaded terminals in the load circuit are not suitable!

Power control

The power regulator adjusts the power in the connected load by means of a solid-state switching device depending on the taught power and the selected setpoint. Changes in the mains voltage or in the load resistance are thus compensated by the power regulator. The setpoint value can be predefined externally as a 0 to 10 V signal or internally by means of a potentiometer. Depending on the setting of the potentiometer (t_R), the adjustment is carried out according to the principle of full-wave control or generalized phase control.

Note:

In the case of ohmic loads, the power is set linear to the setpoint value. During operation of inductive loads, the power control is no longer proportional and linear due to the phase shift between current and voltage.

Full-wave control

In this operating mode the output is adjusted to the required setpoint value by changing the on-to-off period. The period duration is predefined at 1 s.

Notes:

The use of 1-pole solid-state switching devices with converters, power controllers or power regulators in three-phase networks in full-wave control mode is not recommended. Since the function modules do not synchronize with each other, this may lead to fluctuations in the heating power; optimum compensation can no longer be ensured, especially for setpoints < 50%.

Generalized phase control

In this operating mode the output is adjusted to the required setpoint value by changing the current flow angle. In order to observe the limit values of the conducted interference voltage for industrial networks, at loads up to 20 kVA, the load circuit must include an additional filter, and for loads above 20 kVA, a reactor with a rating of at least 200 μ H must be used. You will find details about the filters in the FAQ "Filters for 3RF29 power regulators and power controllers to comply with the limits for electromagnetic emitted interference", see <https://support.industry.siemens.com/cs/ww/en/view/109751887>.



Switching devices – Soft starters and solid-state switching devices

Solid-state switching devices for resistive/inductive loads

Function modules

SIRIUS power regulators for 3RF2

Selection and ordering data

Rated operational current I_e		Rated operational voltage U_e		SD	Screw terminals 	PU (UNIT, SET, M)	PS*	PG
A	V		d	Article No.	Price per PU			
Power regulators								
Rated control supply voltage 24 V AC/DC								
	20	110 ... 230	2	3RF2920-0HA13		1	1 unit	41C
	20	400 ... 600	2	3RF2920-0HA16		1	1 unit	41C
	50	110 ... 230	2	3RF2950-0HA13		1	1 unit	41C
	50	400 ... 600	2	3RF2950-0HA16		1	1 unit	41C
	90	110 ... 230	2	3RF2990-0HA13		1	1 unit	41C
	90	400 ... 600	2	3RF2990-0HA16		1	1 unit	41C

3RF2920-0HA13

Accessories

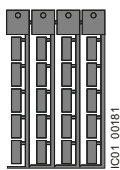
Version	SD	Article No.	Price per PU	PU (UNIT, SET, M)	PS*	PG
d						
Covers						
	Sealable covers for function modules (not for converters)	5	3RF2900-0RA88	1	10 units	41C
	For securing against unauthorized adjustment of setting knobs					
Blank labels						
	Unit labeling plates For SIRIUS devices ¹⁾ 20 mm × 7 mm, titanium gray	20	3RT2900-1SB20	100	340 units	41B
	Adhesive labels For SIRIUS devices 19 mm × 6 mm, titanium gray	5				

3RT2900-1SB20

¹⁾ PC labeling systems for individual inscription of unit labeling plates are available from: murrplastik Systemtechnik GmbH (see page 16/16).

Switching devices – Soft starters and solid-state switching devices

Solid-state switching devices for switching motors

Solid-state contactors

General data

Overview

More information

Industry Mall, see www.siemens.com/product?3RF

Online configurator, see www.siemens.com/sirius/configurators

Solid-state contactors for switching motors



Solid-state contactor for direct-on-line starting

The solid-state contactors for switching motors are intended for frequently switching on and off three-phase current operating mechanisms up to 7.5 kW and reversing up to 3.0 kW. The devices are constructed with complete insulation and can be mounted directly on SIRIUS motor starter protectors, overload relays and current monitoring relays, resulting in a very simple integration into motor feeders.

These 3-phase solid-state contactors are equipped with a 2-phase control which is particularly suitable for typical motor current circuits without connecting to the neutral conductor.

Important features:

- Insulated enclosure with integrated heat sink
- High degree of protection
- Integrated mounting foot to snap on a standard mounting rail or for assembly onto a support plate
- Variety of connection methods
- Plug-in control connection
- Display via LEDs
- Wide voltage range for AC control supply voltage

Switching functions

The solid-state contactors for switching motors are "Instantaneous switching", because this method is particularly suited for inductive loads. By distributing the ON point over the entire sine curve of the mains voltage, disturbances are reduced to a minimum.

Connection methods

You can choose between the following connection methods for the solid-state contactors for switching motors:

Screw terminals

The screw connection system is the standard for industrial controls. Open terminals and a plus-minus screw are just two features of this technology. Two conductors of up to 6 mm² can be connected in just one terminal.

Spring-loaded terminals

This innovative technology manages without any screw connection. This means that very high vibration resistance is achieved. Two conductors of up to 2.5 mm² can be connected to each terminal.

Motor feeders

The devices can use a link module to directly connect to a motor starter protector. Also possible is the mounting of a 3RB30/3RB31 electronic overload relay (see page 7/104) or a 3RR2 current monitoring relay (see pages 10/51 and 10/59) using a link adapter. The simultaneous mounting of a motor starter protector and an overload or current monitoring relay is not recommended for space and heat development reasons.

Rapid-switching fuseless and fused motor feeders can thereby be implemented in a time-saving manner.

Selecting solid-state contactors

The solid-state contactors are selected on the basis of details of the network, the load and the ambient conditions.

The following procedure is recommended:

- Determine the rated current of the load and the mains voltage
- Select a solid-state contactor with the same or higher rated current than the load
- Testing of the maximum permissible switching frequency based on the characteristic curves (see "More information" → "Product information", page 6/159). To do this, the starting current, the starting time and the motor load in the operating phase must be known.
- If the permissible switching frequency is under the desired frequency, it is possible to achieve an increase only by overdimensioning the motor and the solid-state contactor!

Alternatively, the tool for "Selection of solid-state contactors for switching motors" can be used. The correct device size can be determined by entering the network and motor data along with the application and ambient conditions.

Short-circuit protection

Despite the rugged power semiconductors that are used, solid-state switching devices respond more sensitively to short circuits in the load feeder. Consequently, special precautions have to be taken against destruction, depending on the type of design.

Siemens generally recommends using SITOR semiconductor fuses. These fuses also provide protection against destruction in the event of a short circuit even when the solid-state contactors and solid-state relays are fully utilized.

Alternatively, if there is lower loading, protection can also be provided by standard fuses or miniature circuit breakers. This protection is achieved by overdimensioning the solid-state switching devices accordingly.

Switching devices – Soft starters and solid-state switching devices

Solid-state switching devices for switching motors

Solid-state contactors

General data

Online configurator

- Simple selection of individual solid-state switching devices by means of technical characteristics (e.g. zero-point switching, spring-loaded terminals and rated current)
- Once configuration is complete, you receive the article numbers corresponding to the products.

See

www.siemens.com/sirius/configurators

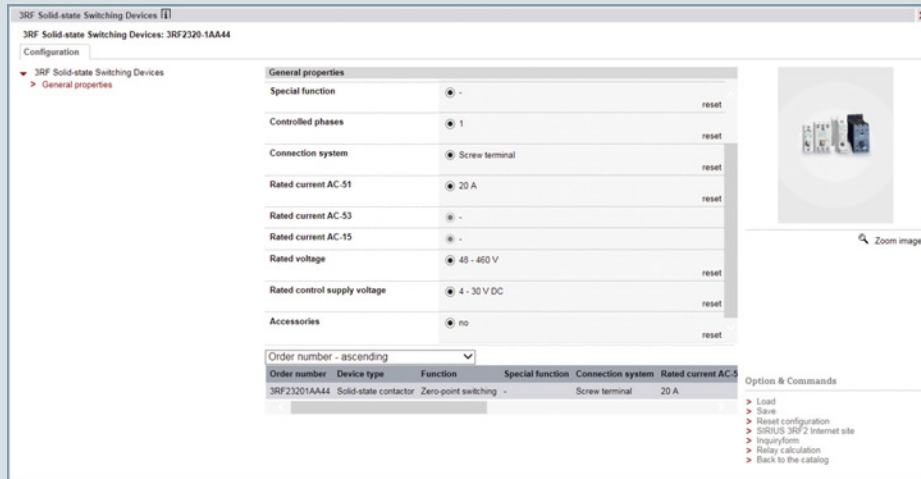

Online configurator for 3RF solid-state switching devices

Article No. scheme

Product versions		Article number						
Solid-state contactors		3RF34	<input type="checkbox"/>	<input type="checkbox"/>	<input type="checkbox"/>	<input type="checkbox"/>	<input type="checkbox"/>	3-phase
Rated operational current	3.8 A	0 3	<input type="checkbox"/>	<input type="checkbox"/>	<input type="checkbox"/>	<input type="checkbox"/>	<input type="checkbox"/>	Only for reversing contactor
	5.2 A (5.4 A for reversing contactor)	0 5	<input type="checkbox"/>	<input type="checkbox"/>	<input type="checkbox"/>	<input type="checkbox"/>	<input type="checkbox"/>	
	9.2 A (7.4 A for reversing contactor)	1 0	<input type="checkbox"/>	<input type="checkbox"/>	<input type="checkbox"/>	<input type="checkbox"/>	<input type="checkbox"/>	
	12.5 A	1 2	<input type="checkbox"/>	<input type="checkbox"/>	<input type="checkbox"/>	<input type="checkbox"/>	<input type="checkbox"/>	Only for solid-state contactor
	16 A	1 6	<input type="checkbox"/>	<input type="checkbox"/>	<input type="checkbox"/>	<input type="checkbox"/>	<input type="checkbox"/>	Only for solid-state contactor
Connection type	Screw terminals		1	<input type="checkbox"/>	<input type="checkbox"/>	<input type="checkbox"/>	<input type="checkbox"/>	
	Spring-loaded terminals		2	<input type="checkbox"/>	<input type="checkbox"/>	<input type="checkbox"/>	<input type="checkbox"/>	
Switching function	Instantaneous switching			B	<input type="checkbox"/>	<input type="checkbox"/>	<input type="checkbox"/>	
	Reversing contactor			D	<input type="checkbox"/>	<input type="checkbox"/>	<input type="checkbox"/>	
Rated control supply voltage U_s	24 V DC				0	<input type="checkbox"/>	<input type="checkbox"/>	
	110 ... 230 V AC				2	<input type="checkbox"/>	<input type="checkbox"/>	
Rated operational voltage U_e	48 ... 460 V AC					4	<input type="checkbox"/>	
	48 ... 600 V AC					6	<input type="checkbox"/>	Blocking voltage 1 600 V, solid-state contactor only
Example		3RF34	1 0	-	1	B B	0 4	

Note:

The Article No. scheme shows an overview of product versions for better understanding of the logic behind the article numbers.

For your orders please use the article numbers quoted in the selection and ordering data.

Benefits

- Units with integrated heat sink, "ready to use"
- Compact and space-saving design
- Reversing contactors with integrated interlocking

Application

Use in load feeders

There is no typical design of a load feeder with solid-state relays or solid-state contactors; instead, the great variety of connection methods and control voltages offers universal application opportunities.

SIRIUS solid-state relays and solid-state contactors can be installed in fuseless or fused feeders, as required.

See Configuration Manual for load feeders, <https://support.industry.siemens.com/cs/ww/en/view/39714188>.

Standards and approvals

- IEC 60947-4-2
- UL 508, CSA for North America¹⁾
- CE marking for Europe
- C-Tick approval for Australia
- CCC approval for China

¹⁾ Please note: Use overvoltage protection device; max. cut-off-voltage 6 000 V; min. energy handling capability 100 J.



Switching devices – Soft starters and solid-state switching devices

Solid-state switching devices for switching motors

Solid-state contactors

General data

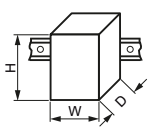
Technical specifications

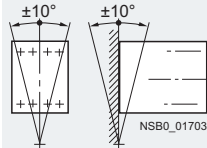
Type		3RF3405-1BB.. 3RF3403-1BD.. 3RF3405-1BD..	3RF3410-1BB.. 3RF3412-1BB.. 3RF3416-1BB.. 3RF3410-1BD..	3RF3405-2BB..	3RF3410-2BB.. 3RF3412-2BB.. 3RF3416-2BB..	
Dimensions (W x H x D)		mm mm	45 x 95 x 96.5 45 x 95 x 108.5	90 x 95 x 96.5 90 x 95 x 108.5	45 x 95 x 96.5 --	90 x 95 x 96.5 --
• 3RF34..-1BB.. • 3RF34..-1BD..						
General technical specifications						
Ambient temperature						
• During operation, derating from 40 °C	°C		-25 ... +60			
• During storage	°C		-55 ... +80			
Installation altitude						
	m		0 ... 1 000; derating over 1 000 m on request			
Shock resistance acc. to IEC 60068-2-27						
	g/ms		15/11			
Vibration resistance acc. to IEC 60068-2-6						
	g		2			
Degree of protection IP on the front acc. to IEC 60529						
			IP20			
Touch protection on the front acc. to IEC 60529						
			Finger-safe for vertical touching from the front			
Insulation strength at 50/60 Hz (main/control circuit to floor)						
	V rms		4 000			
Electromagnetic compatibility (EMC)						
• Emitted interference according to IEC 60947-4-2						
- Conducted interference voltage			Class A for industrial applications ¹⁾			
- Emitted, high-frequency interference voltage			Class A for industrial applications			
• Interference immunity						
- Electrostatic discharge acc. to IEC 61000-4-2 (corresponds to degree of severity 3)	kV		Contact discharge: 4; air discharge: 8; Behavior criterion 2			
- Induced RF fields acc. to IEC 61000-4-6	MHz		0,15 ... 80; 140 dBµV; behavior criterion 1			
- Burst acc. to IEC 61000-4-4	kV		2; at 5 kHz; behavior criterion 2			
- Surge acc. to IEC 61000-4-5 ²⁾	kV		Conductor - ground 2; conductor - conductor 1; behavior criterion 2			
Connection type						
			Screw terminals		Spring-loaded terminals	
Operating devices						
			Standard screwdriver size 2 and Pozidriv 2		3,0 x 0,5 and 3,5 x 0,5	
Conductor cross-sections, main contacts						
• Solid	mm ²		2 x (1,5 ... 2,5) ³⁾ , 2 x (2,5 ... 6) ³⁾		2 x (0,5 ... 2,5)	
• Finely stranded with end sleeve	mm ²		2 x (1 ... 2,5) ³⁾ , 2 x (2,5 ... 6) ³⁾ , 1 x 10		2 x (0,5 ... 1,5)	
• Finely stranded without end sleeve	mm ²		--		2 x (0,5 ... 2,5)	
• AWG cables, solid or stranded	AWG		2 x (14 ... 10)		2 x (18 ... 14)	
Conductor cross-sections, auxiliary/control contacts						
• With/without end sleeve	mm ²		1 x (0,5 ... 2,5), 2 x (0,5 ... 1,0)		0,5 ... 2,5	
• AWG cables, solid or stranded	AWG		20 ... 12		20 ... 12	
Permissible mounting position						
						

¹⁾ These products were built as Class A devices. The use of these devices in residential areas could result in radio interference. In this case it may be required to introduce additional interference suppression measures.

²⁾ The following applies for reversing contactors: To maintain the values, a 3TX7462-3L surge suppressor should be used between phases L1 and L3 as close as possible to the reversing contactor.

³⁾ If two different conductor cross-sections are connected to one clamping point, both cross-sections must lie in one of the ranges specified.

More information

For more information, see

- System Manual for modular system, <https://support.industry.siemens.com/cs/ww/en/view/60311318>
- Equipment Manual for 3RF34 solid-state switching devices, <https://support.industry.siemens.com/cs/ww/en/view/60298187>

Product information and technical specifications

For product data sheets with detailed technical specifications and dimensional drawings, see <https://support.industry.siemens.com/cs/ww/en/ps/16237/td>.

For additional information, please enter the article number of the required device under the tab "Product List".

Switching devices – Soft starters and solid-state switching devices

Solid-state switching devices for switching motors

Solid-state contactors

SIRIUS 3RF34 solid-state contactors, 3-phase

Overview

These 2-phase controlled, instantaneous switching solid-state contactors in the insulating enclosure are offered in a width of 45 mm up to 5.2 A – and in a width of 90 mm up to 16 A. They allow the operation of motors up to 7.5 kW.¹⁾

¹⁾ In accordance with the product standard IEC 60947-4-2, the motor contactors are designed for motors with maximum starting current conditions of $I/I_n \leq 8$. For configuring motors with higher starting current conditions (typically $I/I_n \geq 8$), the data in the Equipment Manual for 3RF34 solid-state switching devices must be taken into account, see <https://support.industry.siemens.com/cs/ww/en/view/60298187>.

Technical specifications

More information

System Manual for modular system, see <https://support.industry.siemens.com/cs/ww/en/view/60311318>
Equipment Manual for 3RF34 solid-state switching devices, see <https://support.industry.siemens.com/cs/ww/en/view/60298187>

FAQs, see <https://support.industry.siemens.com/cs/ww/en/ps/16237/faq>

Type		3RF3405-.BB..	3RF3410-.BB..	3RF3412-.BB..	3RF3416-.BB..
Fuseless design with 3RV2 motor starter protector, CLASS 10					
Rated operational current I_{AC-53a}¹⁾ acc. to IEC 60947-4-2					
• At 40 °C	A	5.2 (4.5)	9.2	12.5	16
• UL/CSA, at 50 °C	A	4.6 (4.0)	8.4	11.5	14
• At 60 °C	A	4.2 (3.5)	7.6	10.5	12.5
Power loss at I_{AC-53a}					
• At 40 °C	W	10 (8)	16	22	28
Short-circuit protection with type of coordination "1" at operational voltage U_e up to 440 V					
• Motor starter protector, type		3RV2011-1GA10	3RV2011-1JA10	3RV2011-1KA10	3RV2011-4AA10
• Current I_q	kA	50	5		3

¹⁾ The reduced values in brackets apply to a directly mounted motor starter protector and simultaneous side-by-side mounting.

Type		3RF3405-.BB.4	3RF3405-.BB.6	3RF3410-.BB..	3RF3412-.BB.4	3RF3412-.BB.6	3RF3416-.BB..
Fused design with directly connected 3RB3 overload relay							
Rated operational current I_{AC-53a} acc. to IEC 60947-4-2							
• At 40 °C	A	4		7.8	9.5		11
• UL/CSA, at 50 °C	A	3.6		7	8.5		10
• At 60 °C	A	3.2		6.2	7.6		9
Power loss at I_{AC-53a}							
• At 40 °C	W	7		13	16		18
Minimum load current							
	A	0.1	0.5				
Max. off-state current							
	mA	10					
Rated peak withstand current I_{tsm}							
	A	200	600		1 200	1 150	
I^2t value							
	A ² s	200	1 800		7 200	6 600	

Switching devices – Soft starters and solid-state switching devices

Solid-state switching devices for switching motors

Solid-state contactors

SIRIUS 3RF34 solid-state contactors, 3-phase

Type		3RF34...-BB.4	3RF34...-BB.6
Main circuit			
Controlled phases		2-phase	
Rated operational voltage U_e	V AC	48 ... 480	48 ... 600
• Operating range	V AC	40 ... 506	40 ... 660
• Rated frequency	Hz	50/60 ± 10%	
Rated insulation voltage U_i	V	600	
Rated impulse withstand voltage U_{imp}	kV	6	
Blocking voltage	V	1 200	1 600
Rate of voltage rise	V/μs	1 000	
Control circuit			
Type		3RF34...-BB0.	3RF34...-BB2.
Method of operation		DC operation	AC operation
Rated control supply voltage U_s	V	24	110 ... 230
Rated frequency of the control supply voltage	Hz	--	50/60 ± 10%
Control supply voltage, max.	V	30	253
Typical actuating current	mA	20	15
Response voltage	V	15	90
Drop-out voltage	V	5	< 40
Operating times			
• ON-delay	ms	1	5
• OFF-delay	ms	1 + max. one half-wave	30 + max. one half-wave

Switching devices – Soft starters and solid-state switching devices

Solid-state switching devices for switching motors

Solid-state contactors

SIRIUS 3RF34 solid-state contactors, 3-phase





Selection and ordering data

More information

System Manual for modular system, see
<https://support.industry.siemens.com/cs/ww/en/view/60311318>

Equipment Manual for 3RF34 solid-state switching devices, see
<https://support.industry.siemens.com/cs/ww/en/view/60298187>

Motor contactors · Instantaneous switching · 2-phase controlled

Rated operational current I_e	Rated power at I_e and U_e	Rated control supply voltage U_s	SD	Screw terminals		PU (UNIT, SET, M)	PS*	PG
				Article No.	Price per PU			
A	400 V kW	V	d					
Rated operational voltage U_e								
48 ... 480 V AC								
	5.2	2.2	24 DC	2	3RF3405-1BB04	1	1 unit	41C
	9.2	4.0		5	3RF3410-1BB04	1	1 unit	41C
	12.5	5.5		5	3RF3412-1BB04	1	1 unit	41C
	16	7.5		5	3RF3416-1BB04	1	1 unit	41C
	5.2	2.2	110 ... 230 AC	5	3RF3405-1BB24	1	1 unit	41C
	9.2	4.0		5	3RF3410-1BB24	1	1 unit	41C
	12.5	5.5		5	3RF3412-1BB24	1	1 unit	41C
	16	7.5		5	3RF3416-1BB24	1	1 unit	41C
Rated operational voltage U_e								
48 ... 600 V AC, blocking voltage 1 600 V								
	5.2	2.2	24 DC	5	3RF3405-1BB06	1	1 unit	41C
	9.2	4.0		5	3RF3410-1BB06	1	1 unit	41C
	12.5	5.5		5	3RF3412-1BB06	1	1 unit	41C
	16	7.5		5	3RF3416-1BB06	1	1 unit	41C
	5.2	2.2	110 ... 230 AC	5	3RF3405-1BB26	1	1 unit	41C
	9.2	4.0		5	3RF3410-1BB26	1	1 unit	41C
	12.5	5.5		5	3RF3412-1BB26	1	1 unit	41C
	16	7.5		5	3RF3416-1BB26	1	1 unit	41C
Rated operational voltage U_e								
48 ... 480 V AC								
	5.2	2.2	24 DC	5	3RF3405-2BB04	1	1 unit	41C
	9.2	4.0		5	3RF3410-2BB04	1	1 unit	41C
	12.5	5.5		5	3RF3412-2BB04	1	1 unit	41C
	16	7.5		5	3RF3416-2BB04	1	1 unit	41C
	5.2	2.2	110 ... 230 AC	5	3RF3405-2BB24	1	1 unit	41C
	9.2	4.0		5	3RF3410-2BB24	1	1 unit	41C
	12.5	5.5		5	3RF3412-2BB24	1	1 unit	41C
	16	7.5		5	3RF3416-2BB24	1	1 unit	41C
Rated operational voltage U_e								
48 ... 600 V AC, blocking voltage 1 600 V								
	5.2	2.2	24 DC	5	3RF3405-2BB06	1	1 unit	41C
	9.2	4.0		5	3RF3410-2BB06	1	1 unit	41C
	12.5	5.5		5	3RF3412-2BB06	1	1 unit	41C
	16	7.5		5	3RF3416-2BB06	1	1 unit	41C
	5.2	2.2	110 ... 230 AC	5	3RF3405-2BB26	1	1 unit	41C
	9.2	4.0		5	3RF3410-2BB26	1	1 unit	41C
	12.5	5.5		5	3RF3412-2BB26	1	1 unit	41C
	16	7.5		5	3RF3416-2BB26	1	1 unit	41C

3RF3405-1BB

3RF3410-1BB

3RF3405-2BB

3RF3410-2BB







Switching devices – Soft starters and solid-state switching devices

Solid-state switching devices for switching motors

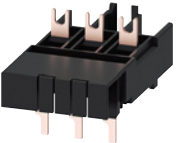
Solid-state contactors

IE3/IE4 ready SIRIUS 3RF34 solid-state contactors, 3-phase

Accessories

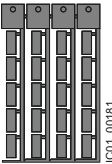
Version	SD	Article No.	Price per PU	PU (UNIT, SET, M)	PS*	PG
Link modules between solid-state contactor and motor starter protector						
		Link modules Between solid-state contactor and motor starter protector with screw terminals For 3RV2 motor starter protectors size S00/S0	Screw terminals 			
3RA2921-1BA00				1	1 unit	41B
Link adapters between solid-state contactor and overload relay						
		Link adapters For direct mounting of 3RB3 overload relays or 3RR2 current monitoring relays to the solid-state contactor with screw terminals The adapter is snapped onto the enclosure of the 3RF34 contactor and accommodates the fixing hooks of the 3RB3 overload relays or the 3RR2 current monitoring relays for direct mounting.				
3RF3900-0QA88	5		3RF3900-0QA88	1	1 unit	41C
Insulation stop for securely holding back the conductor insulation, on conductors up to 1 mm²						
		Insulation stop strip For all SIRIUS devices with spring-loaded terminals Can be inserted in the cable entry of the spring-loaded terminal (no more than two strips per contactor required; removable in pairs) For terminals with a conductor cross-section up to 2.5 mm ²	Spring-loaded terminals 			
3RT2916-4JA02	2		3RT2916-4JA02	1	20 units	41B
Tools for opening spring-loaded terminals						
		Screwdrivers For all SIRIUS devices with spring-loaded terminals Length approx. 200 mm, size 3.0 mm x 0.5 mm, titanium gray/black, partially insulated				
3RA2908-1A	2		3RA2908-1A	1	1 unit	41B
Control connectors						
		Control connectors For solid-state contactors with spring-loaded terminals with two clamping points per contact				
3RF2900-2TB88	5		3RF2900-2TB88	1	10 units	41C
Blank labels						
		Unit labeling plates For SIRIUS devices ¹⁾ 20 mm x 7 mm, titanium gray				
	20		3RT2900-1SB20	100	340 units	41B
		Adhesive labels For SIRIUS devices 19 mm x 6 mm, titanium gray				
	5		3RT2900-1SB60	100	3060 units	41B

¹⁾ PC labeling systems for individual inscription of unit labeling plates available from: murrplastik Systemtechnik GmbH (see page 16/16).

Switching devices – Soft starters and solid-state switching devices

Solid-state switching devices for switching motors

Solid-state contactors

SIRIUS 3RF34 solid-state reversing contactors, 3-phase

Overview

The integration of four conducting paths to a reverse switch, combined in one enclosure makes this device a particularly compact solution. Compared to conventional systems, for which two contactors are required, it is possible to save up to 50% in width with the 3-phase reversing contactors. Devices with a width of 45 mm cover motors up to 2.2 kW – and those with a width of 90 mm cover motors up to 3 kW.¹⁾

¹⁾ In accordance with the product standard IEC 60947-4-2, the motor contactors are designed for motors with maximum starting current conditions of $I/I_e \leq 8$. For configuring motors with higher starting current conditions (typically $I/I_e \geq 8$), the data in the Equipment Manual for 3RF34 solid-state switching devices must be taken into account, see <https://support.industry.siemens.com/cs/ww/en/view/60298187>.

Technical specifications

More information

System Manual for modular system, see <https://support.industry.siemens.com/cs/ww/en/view/60311318>

FAQs, see <https://support.industry.siemens.com/cs/ww/en/ps/16237/faq>

Equipment Manual for 3RF34 solid-state switching devices, see <https://support.industry.siemens.com/cs/ww/en/view/60298187>

Type		3RF3403-.BD.4	3RF3405-.BD.4	3RF3410-.BD.4
Fuseless design with 3RV2 motor starter protector, CLASS 10				
Rated operational current I_{AC-53a}¹⁾ acc. to IEC 60947-4-2				
• At 40 °C	A	3.8 (3.4)	5.4 (4.8)	7.4
• UL/CSA, at 50 °C	A	3.5 (3.1)	5 (4.3)	6.8
• At 60 °C	A	3.2 (2.8)	4.6 (3.8)	6.2
Power loss at I_{AC-53a}				
• At 40 °C	W	7 (6)	9 (8)	13
Short-circuit protection with type of coordination "1" at operational voltage U_e up to 440 V				
• Motor starter protector, type		3RV2011-1FA10	3RV2011-1GA10	3RV2011-1JA10
• Current I_q	kA	50		10

¹⁾ The reduced values in brackets apply to a directly mounted motor starter protector and simultaneous side-by-side mounting.

Type		3RF3403-.BD.4	3RF3405-.BD.4	3RF3410-.BD.4
Fused design with directly connected 3RB3 overload relay				
Rated operational current I_{AC-53a} acc. to IEC 60947-4-2				
• At 40 °C	A	3.8	5.4	7.4
• UL/CSA, at 50 °C	A	3.5	5	6.8
• At 60 °C	A	3.2	4.6	6.2
Power loss at I_{AC-53a}				
• At 40 °C	W	6	8	16
Minimum load current				
	A	0.5		
Max. off-state current				
	mA	10		
Rated peak withstand current I_{tSM}				
	A	200	600	
I^2t value				
	A ² s	200	1 800	

Switching devices – Soft starters and solid-state switching devices

Solid-state switching devices for switching motors

Solid-state contactors

SIRIUS 3RF34 solid-state reversing contactors, 3-phase

Type	3RF34...BD.4	
Main circuit		
Controlled phases	2-phase	
Rated operational voltage U_e¹⁾	V AC	48 ... 480
• Operating range	V AC	40 ... 506
• Rated frequency	Hz	50/60 ± 10%
Rated insulation voltage U_i	V	600
Rated impulse withstand voltage U_{imp}	kV	6
Blocking voltage	V	1 200
Rate of voltage rise	V/μs	1 000

¹⁾ To reduce the risk of a phase short circuit due to overvoltage, we recommend using a varistor type 3TX7462-3L between the phases L1 and L3 as close as possible to the switchgear. We recommend a design with semiconductor protection as short-circuit protection.

Type	3RF34...BD0.	3RF34...BD2.
Control circuit		
Method of operation	DC operation	AC operation
Rated control supply voltage U_s	V	24
Rated frequency of the control supply voltage	Hz	--
Control supply voltage, maximum	V	30
Typical actuating current	mA	15
Response voltage	V	15
Drop-out voltage	V	5
Operating times¹⁾		
• ON-delay	ms	5
• OFF-delay	ms	5 + max. one half-wave
• Interlocking time	ms	60 ... 100

¹⁾ Caution! Risk of phase short circuit in automatic mode.
The control inputs must not be actuated until a delay of 40 ms has expired after the main voltage is applied.

Switching devices – Soft starters and solid-state switching devices



Solid-state switching devices for switching motors

Solid-state contactors



SIRIUS 3RF34 solid-state reversing contactors, 3-phase

Selection and ordering data

Reversing contactors · Instantaneous switching · 2-phase controlled

Rated operational current I_e	Rated power at I_e and U_e	Rated control supply voltage U_s	SD	Screw terminals 	PU (UNIT, SET, M)	PS*	PG
A	400 V kW	V	d	Article No.	Price per PU		
Rated operational voltage U_e 48 ... 480 V AC							
	3.8	1.5	24 DC	2	3RF3403-1BD04	1	1 unit 41C
	5.4	2.2		5	3RF3405-1BD04	1	1 unit 41C
	7.4	3.0		5	3RF3410-1BD04	1	1 unit 41C
	3.8	1.5	110 ... 230 AC	5	3RF3403-1BD24	1	1 unit 41C
	5.4	2.2		5	3RF3405-1BD24	1	1 unit 41C
	7.4	3.0		5	3RF3410-1BD24	1	1 unit 41C

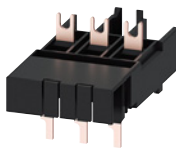
Accessories

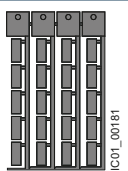
Version	SD	Article No.	Price per PU	PU (UNIT, SET, M)	PS*	PG	
	d						
Link modules between solid-state contactor and motor starter protector							
		Link modules Between solid-state reversing contactor and motor starter protector with screw terminals For 3RV2 motor starter protectors, size S00/S0	Screw terminals 				
			3RA2921-1BA00	1	1 unit	41B	
Link adapters between solid-state contactor and overload relay							
		Link adapters For direct mounting of 3RB3 overload relays or 3RR2 current monitoring relays to the solid-state contactor with screw terminals					
		The adapter is snapped onto the enclosure of the 3RF34 contactor and accommodates the fixing hooks of the 3RB3 overload relays or the 3RR2 current monitoring relays for direct mounting.		5	3RF3900-0QA88	1	1 unit 41C
Blank labels							
		Unit labeling plates For SIRIUS devices ¹⁾ 20 mm × 7 mm, titanium gray		20	3RT2900-1SB20	100	340 units 41B
		Adhesive labels For SIRIUS devices 19 mm × 6 mm, titanium gray		5	3RT2900-1SB60	100	3060 units 41B

¹⁾ PC labeling systems for individual inscription of unit labeling plates available from: murrplastik Systemtechnik GmbH (see page 16/16).