



# CPLS

## Asynchronous motors for variable frequency



95 Nm to 2900 Nm



**LEROY-SOMER**™

***Nidec***  
All for dreams



### Introduction

The range of **IP23** protection **CPLS** asynchronous motors was designed for fixed and variable speed applications when there is little space available or (and) there is a wide speed variation range.

**Supplied by frequency drives**, these motors operate in an open or closed loop. They deliver their rated torques as standard ( $M_N$ ) up to their base speeds ( $n_1$ ) and then supply constant power  $P_N$  from speed  $n_1$  to speed  $n_2$ .

Squirrel cage motors are well suited to operation in de-fluxed mode and, thanks to adapted laminations, over a wide speed range.

Each machine is defined **by its design torque**, this torque being available in **continuous service** below the base speed thanks to efficient radial ventilation.

The performance of these motors are comparable to direct current machines and with some characteristics

of brushless motors. **Inertia is reduced**, they provide good **dynamic performance**.

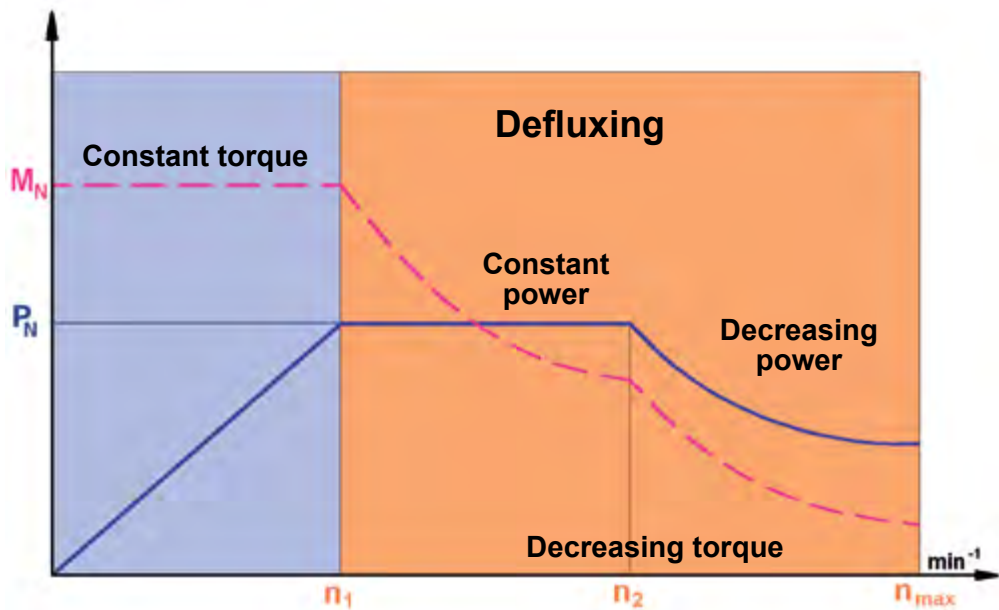

## Contents

---

Index .....	5
<b>GENERAL INFORMATION</b>	
General description .....	6
Components .....	6
Normal operating conditions and corrective factors .....	7
Increased winding insulation .....	7
Mounting arrangements .....	8
Position of the terminal box and the forced ventilation .....	9
Characteristics of forced ventilation motors .....	10
Permissible radial loads (ball bearings) .....	11 to 14
Permissible radial loads (roller bearings) .....	15 to 18
Noise and vibration .....	19
External finishing .....	20
High Speed Configurations .....	21
Complete description .....	22
<b>ELECTRICAL CHARACTERISTICS</b>	
Choice of motor .....	23
Choice of drive .....	23
Selection example .....	24
Selection tables .....	26 to 46
<b>OPTIONAL EQUIPMENT</b>	
Encoder .....	47 - 48
Reinforced bearings .....	49
Thermal protection .....	50
Ventilation .....	51
Heating .....	52
<b>DIMENSIONS</b>	
Terminal box and cable glands .....	53
Foot, foot and flange fixing .....	54

*Leroy-Somer reserves the right to modify the characteristics of its products at any time in order to incorporate the latest technological developments. The information contained in this document is therefore liable to be changed without notice.*

## Index

---

Altitude .....	7 - 24
Ambient temperature .....	7
<b>Cable glands</b> .....	9 - 22 - 49 - 53
Connection .....	6 - 47 - 48
Cooling .....	6 - 10 - 51
CSA .....	6
<b>Degree of protection</b> .....	3 - 6 - 7 - 47
Dimensions .....	53 - 54
<b>End shields</b> .....	6 - 9 - 20 - 49
Environment .....	20 - 24 - 51 - 52
Exploded view .....	6
External finishing .....	6 - 20
<b>Flange</b> .....	6 - 54
Forced ventilation .....	9 - 10 - 51
<b>Heating</b> .....	52
High speed .....	6 - 21 - 22
Humidity .....	6 - 7 - 52
<b>IEC</b> .....	6 - 7 - 19 - 20
Insulation .....	6 - 7
Intermittent service .....	7
<b>Lifting rings</b> .....	6
<b>Noise</b> .....	9 - 19
Noise level .....	19
<b>Operating positions</b> .....	8 - 53
Options .....	6 - 53
<b>Parts list</b> .....	6
<b>Rotor</b> .....	6 - 49
<b>Terminal box</b> .....	6 - 8 - 9 - 20 - 22 - 53 - 54
Thermal protection .....	50
<b>UL</b> .....	6
<b>Vibration level</b> .....	19
Vibrations .....	19

# CPLS

## Asynchronous motors for variable frequency

### General information

### Description

- **CPLS series asynchronous motor**, frame height 112 to 250 mm.
- **Protection**: IP23.
- **Mounting type**: B3 or B35, all mounting positions.
- **Power supply**: standard three-wire, power supply via frequency drive.
- **Winding**: class F as standard. 150°C PTC sensor protection.
- **Magnetic laminations**: designed to provide good characteristics in the usage range including in defluxed mode.
- **Rotor**: aluminium or copper, depending on the size. Class A balancing as standard, to ISO 8821, by half key (letter H).
- **Housing**: steel.
- **End shields**: cast iron fixed by tie rods. The fixing feet are joined to the DE and NDE shields.
- **Terminal box**: aluminium. It can be orientated every 90°, on either side of the DE shield or NDE shield.

There are only three connection cables available in the terminal box.

**⚠ WARNING: the terminal box cover must be closed again once the connection of the cables is complete.**

- **Ball bearings**: C3 play, greased for life as standard.

- **Handling rings**: depending on the types, they are fixed by screws to the machine's end shields.

- **Ventilation**: three-phase radial auxiliary fan provides good cooling, whatever the machine's speed. The standardised cooling mode as per IEC 34-6 is IC06.

Unless specified, cooling air must be between +5°C and +40°C with a humidity lower than 80% RH.

The fan can be orientated every 90°, on either side of the DE shield or NDE shield.

As standard the fan voltage is: 230/400V 50 Hz and 265/460V 60 Hz.

The fan motor power varies with the size of the machine: see page 9.

- **Finish**: paint RAL 6000 (green).

Identification on the name plate fixed on the motor housing.

- **Available options**

- Drive end roller bearings
- Special high-speed bearings
- Class B balancing
- Special shaft ends
- Flanges different from the standard ones by frame height.
- Filter on radial FV (standard or Miovyl)
- Cooling via pipe
- Offset axial fan
- Fan pressure switch
- Second shaft end
- PTO, PTF, KTY, PT100 sensors in the windings or end shields.
- Incremental encoder, absolute encoder
- Brake.

- **Other options upon request**

- Increase in the constant power operating range with our CONSTANT POWER SYSTEM (patented system)
- UL CSA for the motor insulation system (file E68 554).

### Components

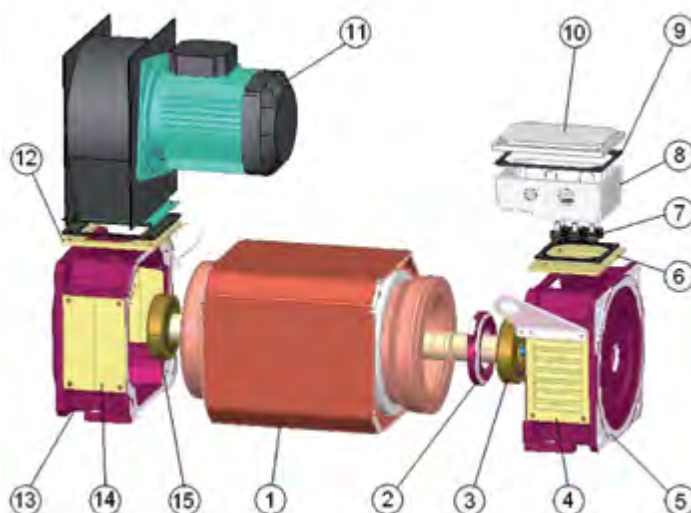

Ref.	Name	Ref.	Name
1	Stator in its housing	9	Terminal box seal
2	Bearing flange (depending on fitting type)	10	Terminal box cover
3	Bearing	11	Forced ventilation
4	Fan grille	12	Fan seal
5	DE shield	13	NDE shield
6	Terminal box support plate	14	Closure plate
7	Terminal plate	15	NDE bearing
8	Terminal box body		

# CPLS

## Asynchronous motors for variable frequency

### General information

#### Normal conditions for use and correction factors

According to IEC 60034-1, standard motors can operate in the following normal conditions:

- ambient temperature between +5°C and +40°C.
- altitude less than 1,000m
- atmospheric pressure up to 1050 mbar.
- operating zone 2 (absolute humidity between 5 and 23 g/cm<sup>3</sup>).
- ambient air chemically neutral and dust-free.

#### Corrections in respect of altitude and ambient temperature

For different conditions of use, the

power correction coefficient indicated in the table below will be indicated.

P1/P	amb (°C) ≤ 40°C	amb (°C) ≤ 50°C	amb (°C) ≤ 60°C
Altitude ≤ 1000 m	1	0.93	0.85
Altitude ≤ 2000 m	0.93	0.85	0.75

The P1/P factor gives the correction coefficient

P1: corrected power

P: catalogue power.

A more detailed graph is available in the Leroy-Somer type LS three-phase asynchronous motor catalogue.

#### Corrections depending on service:

Service type	Running time		
	10 min	30 min	60 min
S2	1.6	1.3	1.1

Service type	Duty cycle		
	25%	40%	60%
S3	1.4	1.2	1.1
S6	1.4	1.3	1.2

### Increased winding insulation

Standard motors in the CPLS range are compatible with power supplies with the following characteristics:

- U = 480 V max.
- Value of voltage peaks generated at the terminals: 1,500 V max. with 3.8 kV / μs

However, they may be supplied under more severe conditions, using additional protection (miscellaneous filters, chokes, etc.).

The main effect associated with supplying power via an electronic drive is overheating of the motor due to the non-sinusoidal shape of the signal.

In addition, this can result in accelerated aging of the winding through the voltage peaks generated at each pulse in the power supply signal (see Figure 1).

Supplying motors via frequency drives generates significant voltage differences in the winding between the turns on the same phase.

For this reason, all the motors in the CPLS range benefit as standard from increased insulation which allows them to comply with the recommendations in standard IEC TS 60034-25 (curve A).

For example: 1.5 kV peak between phases with a rise time of 0.4 sec, i.e. 3.8 kV/sec.

For more severe conditions, additional protection is necessary (choke, dv/dt filter, sine wave filter).

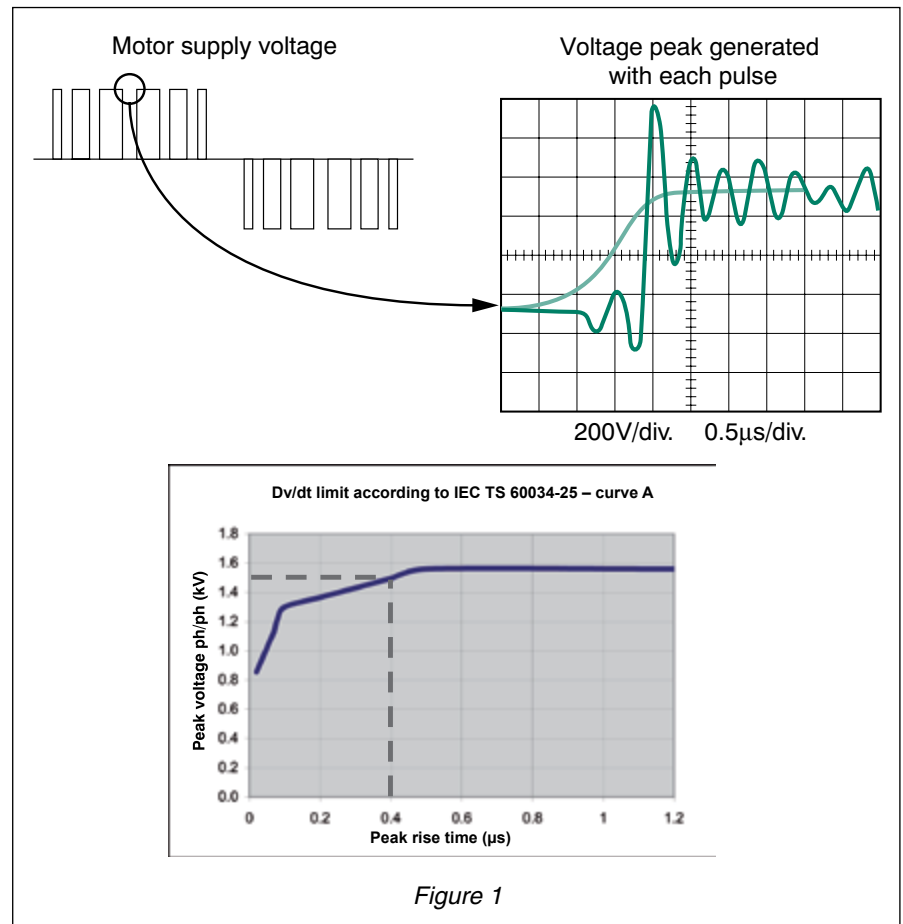
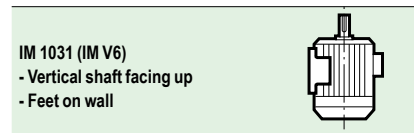
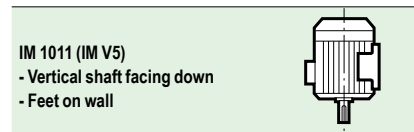

Figure 1

CPLS  
Asynchronous motors for variable frequency  
General information  
**Mounting arrangements**

**Mountings and positions (IEC standard 60034-7)**

**Foot mounted motors**



**(FF) flange mounted motors**

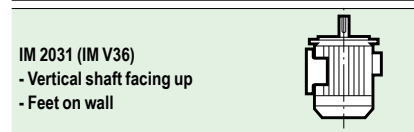
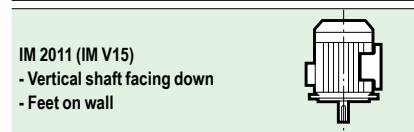
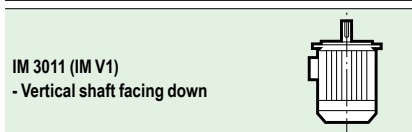

**(FT) face mounted motors**

Consult us

Possible directions of radial loads according to the foot position

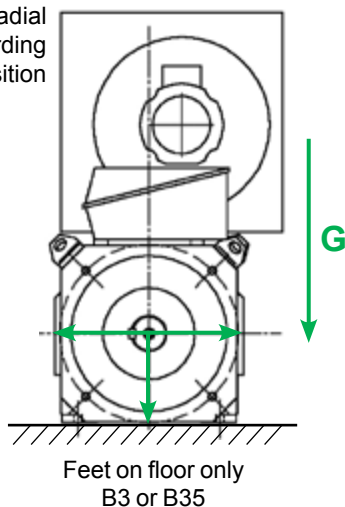

For motors positioned with their feet on the wall, only position B or D is permitted for the forced ventilation unit

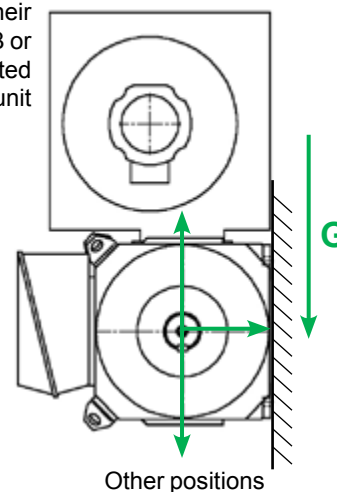



**Position of the terminal box and the forced ventilation**

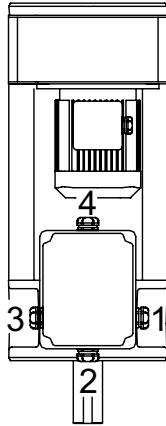

Position of the exit from the glands in relation to the shaft end.

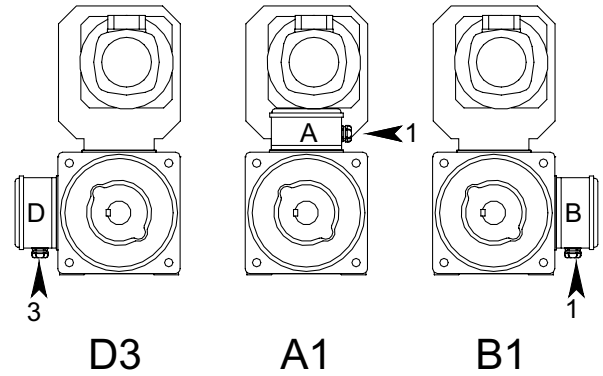

Position of the terminal box and cable glands  
(For terminal box fitting possibilities, see page 52.)

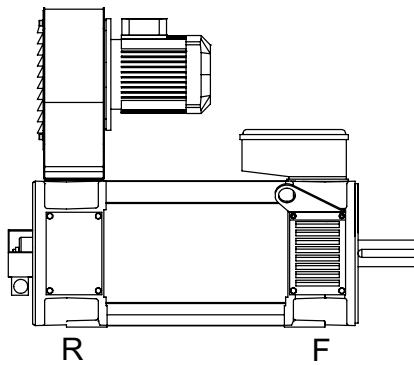

Position of the terminal box and ventilation in relation to the motor end shield.

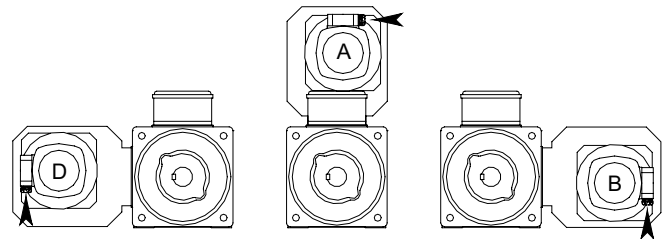

Position of the forced ventilation  
(viewed from shaft end)

F: on DE shield  
R: on NDE shield

*Example:*

*Terminal box in position A1 on DE shield, ventilation in position B mounted on the NDE shield.*

*Designation: A1 F - B R*

*position of terminal box and cable glands*

*position of FV*

# CPLS

## Asynchronous motors for variable frequency

### General information

### Characteristics of forced ventilation motors

CPLS motor Size	"2-pole" ventilation asynchronous motor							
Cooling	Rated power	Permissible voltage	Rated current	Frequency	Type LS*	Flange	Shaft	Mass
IC 06	<i>kW</i>	<i>V</i>	<i>A</i>	<i>Hz</i>		<i>mm</i>	<i>mm</i>	<i>kg</i>
CPLS 112 CPLS 132	0.37	220 to 240 Δ 80 to 415 Y	Δ 1.7 Y 1 (380 V)	50	LS 71 L	FF 130 (CPLS 112)	14 x 30 (CPLS 112)	6.4
	0.44	254 à 280 Δ 440 à 480 Y	Δ 1,7 (254 V) Y 0,95	60	LS 71 L	FF 165 (CPLS 132)	19 x 40 (CPLS 132)	
CPLS 160	1.1	230 Δ	Δ 4	50	LSES 80 L	FF 165	19 x 40	10.7
	1,3	265 Δ	Δ 3.8	60	LSES 90 L			16.1
CPLS 200	2.2	230 Δ	Δ 7.8	50	LSES 90 L	FT 130	24 x 50	16.1
	2,2	265 Δ	Δ 6.9	60	LSES 90 L			
CPLS 250	3	230 Δ	Δ 10.2	50	LSES 100 L	FT 130	28 x 60	22.2
	3.6	265 Δ	Δ 10.2	60	LSES 100 LU			26,5

\* LS: Eff2  
LSES: IE2

If the distribution grid is different, state the frequency and voltage on the order.

# CPLS

## Asynchronous motors for variable frequency

### General information

#### Permissible radial loads (ball bearings)

Maximum radial load permitted on the end of the main shaft, horizontal or vertical motor, shaft end up or down and ball bearing for a service life  $L_{10h}$  calculated at 20,000 hours.

In pulley and belt couplings, the end of the drive shaft with the pulley is subjected to a radial force  $Fr$  applied at a distance  $X$  (mm) from the support at the end of a shaft of length  $E$ .

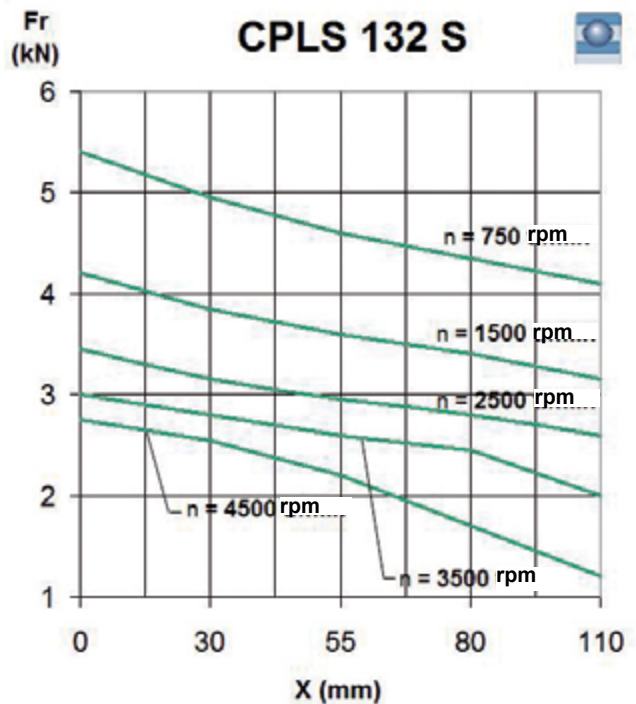
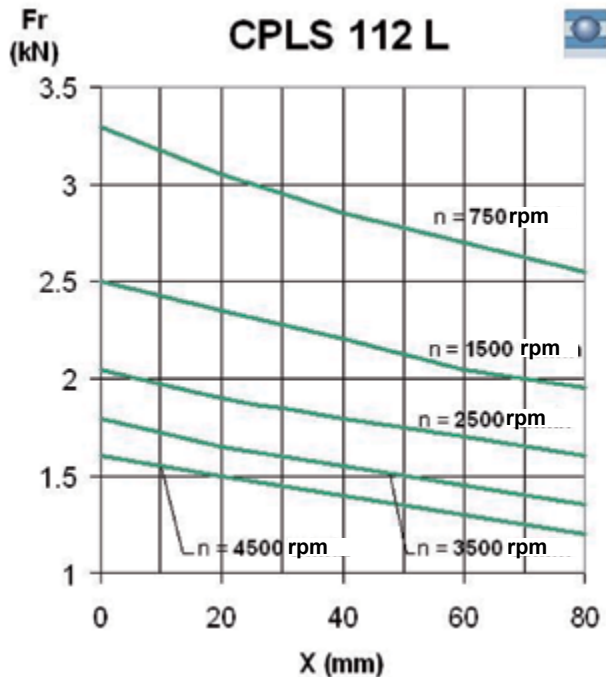
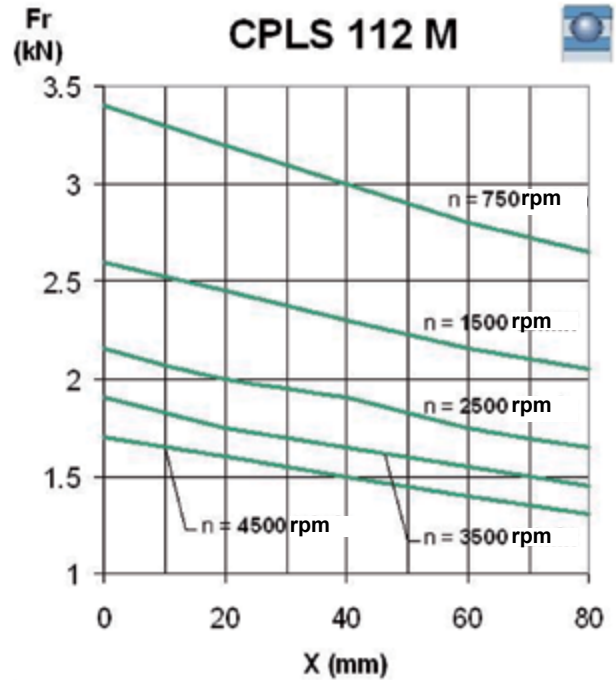
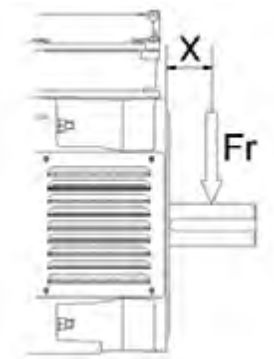

# CPLS

Asynchronous motors for variable frequency

General information

## Permissible radial loads (ball bearings)

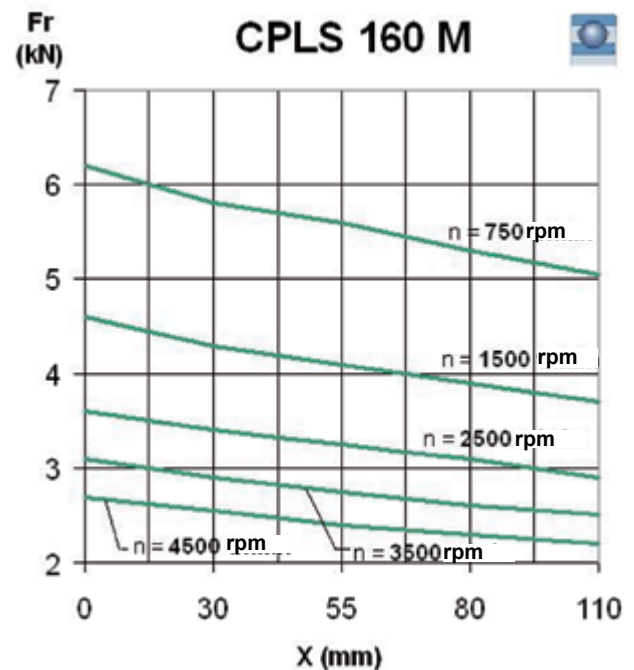
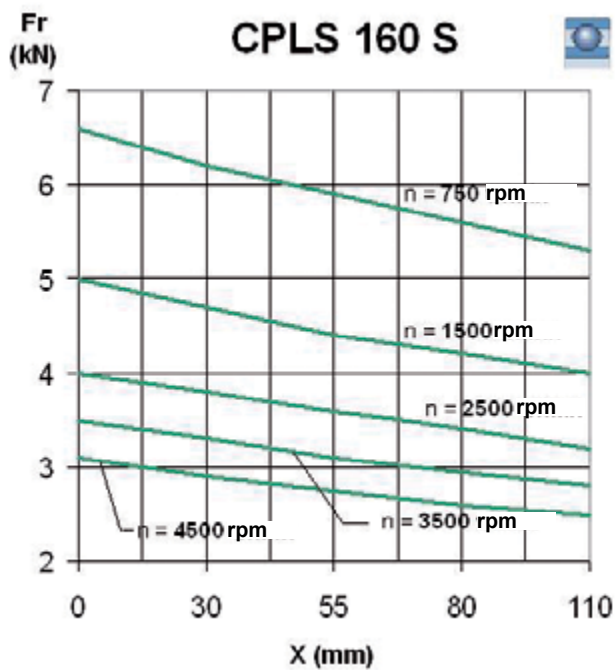
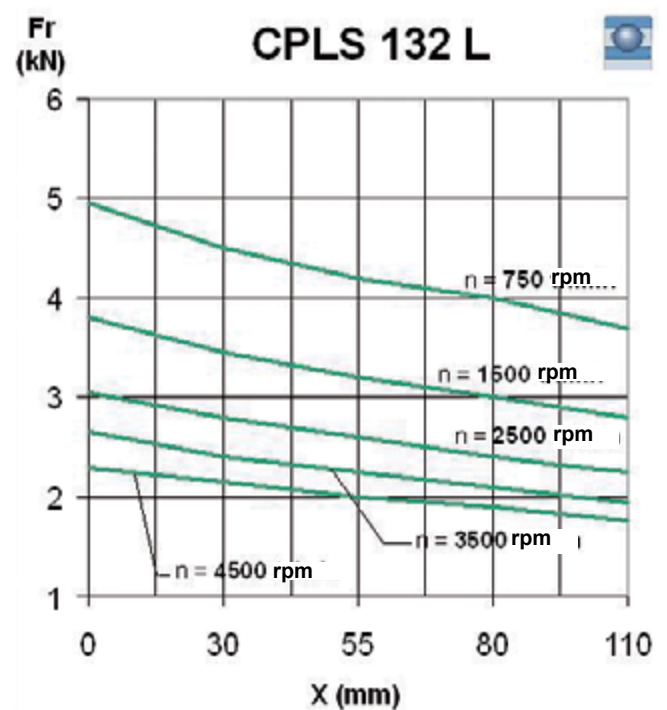
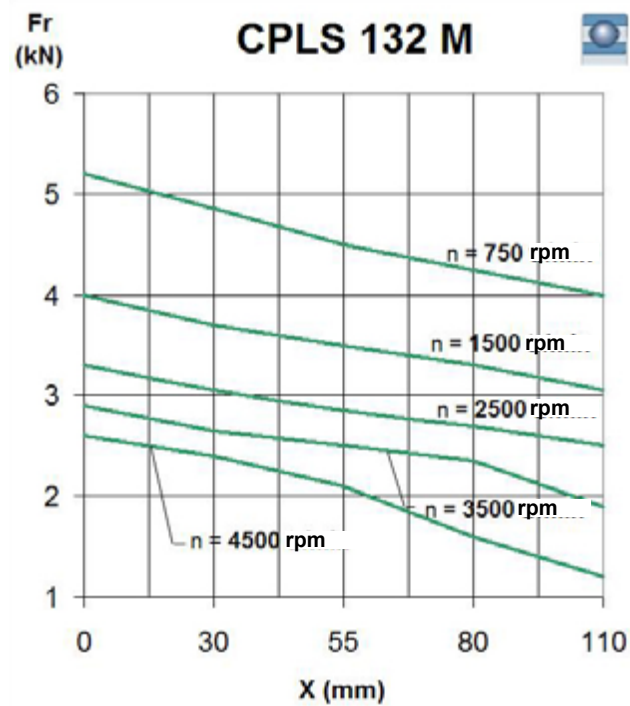

# CPLS

Asynchronous motors for variable frequency

General information

## Permissible radial loads (ball bearings)

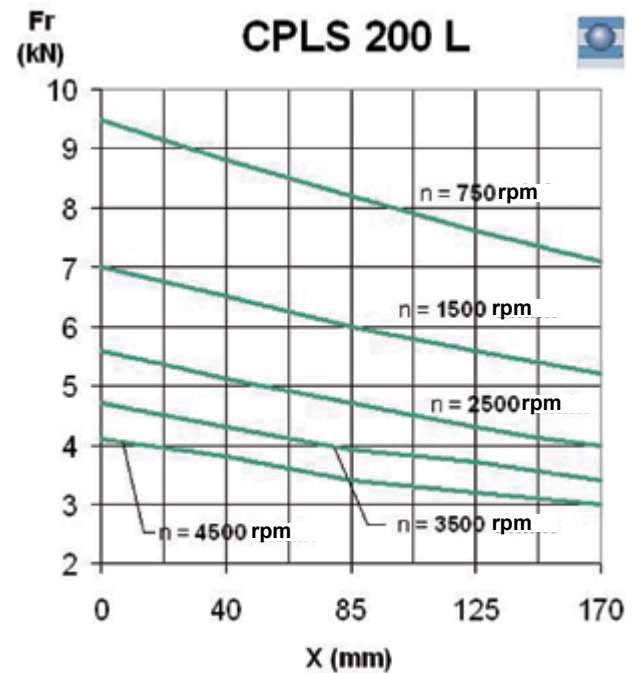
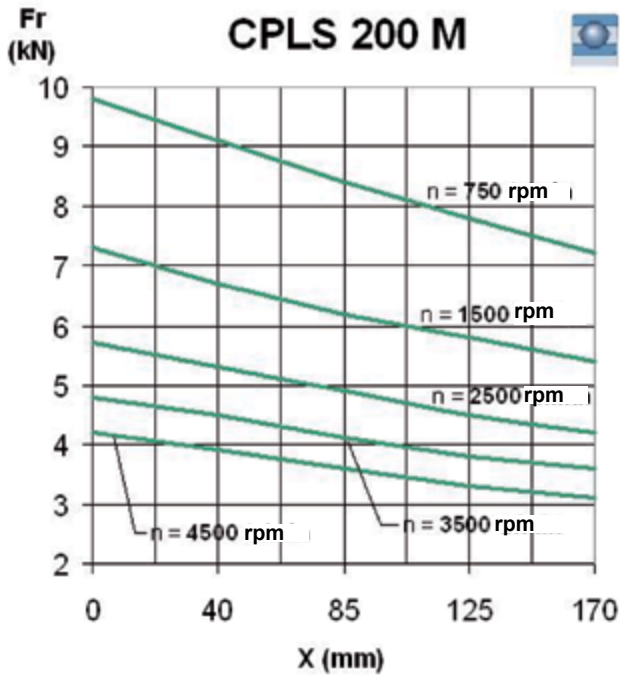
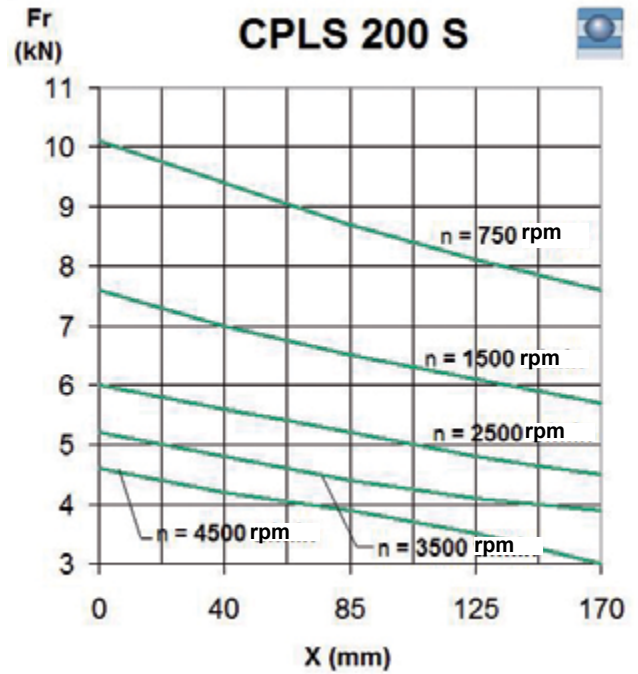
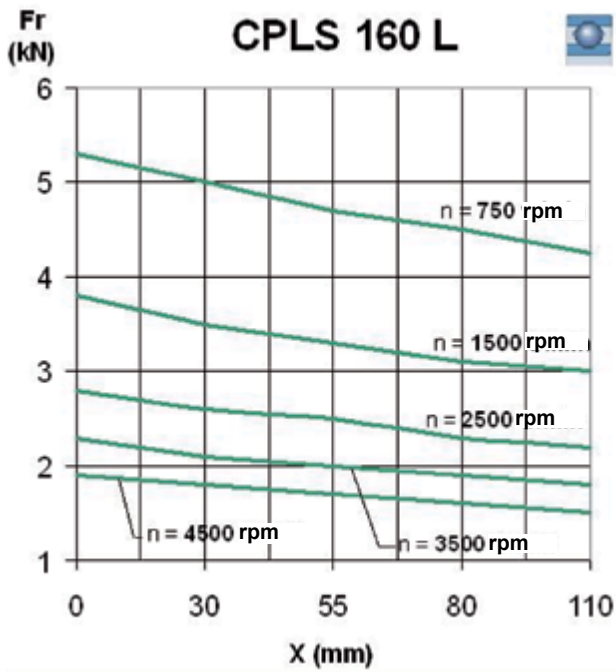

# CPLS

Asynchronous motors for variable frequency

General information

## Permissible radial loads (ball bearings)

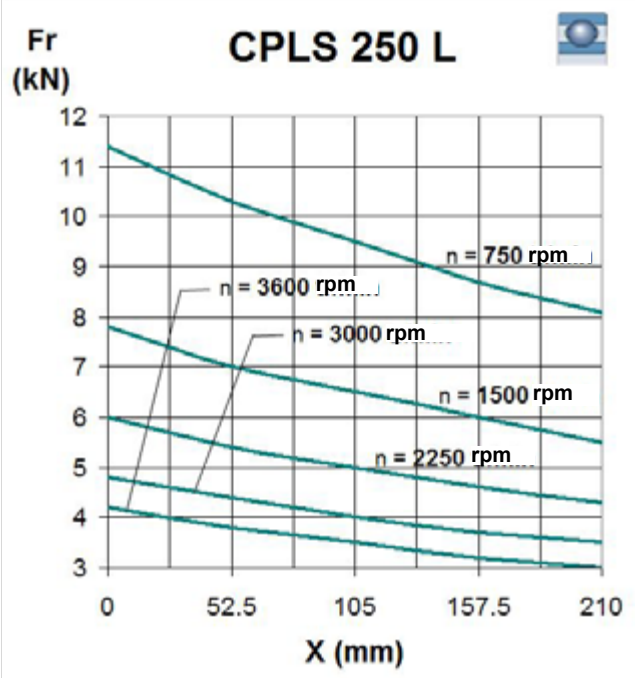
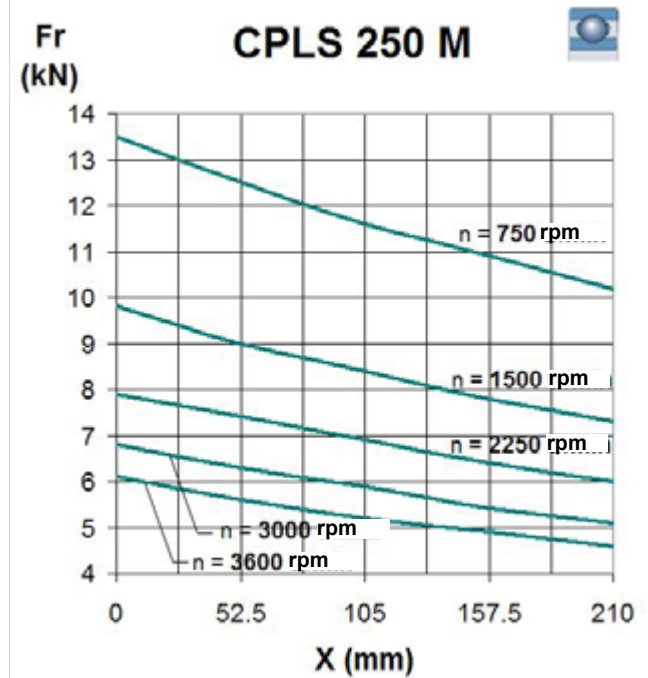
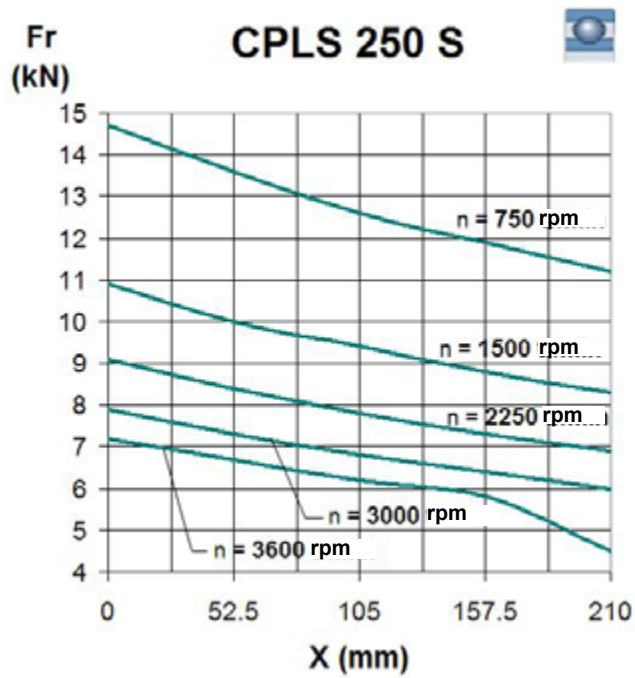

# CPLS

## Asynchronous motors for variable frequency

### General information

#### Permissible radial loads (roller bearings)

Maximum radial load permitted on the end of the main shaft, horizontal motor and roller bearing for a service life  $L_{10h}$  calculated at 20,000 hours.

In pulley and belt couplings, the drive shaft carrying the pulley is subjected to a radial force  $Fr$  applied at a distance  $X$  (mm) from the support at the end of a shaft of length  $E$ .

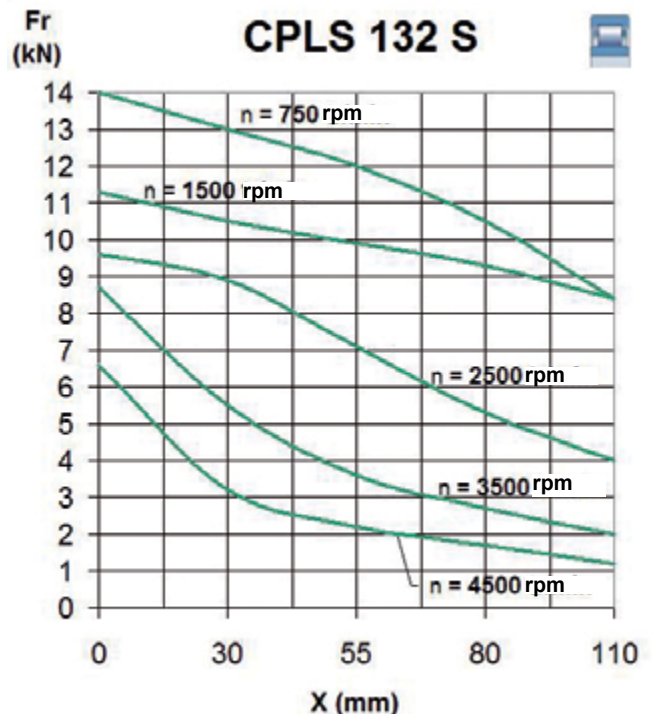
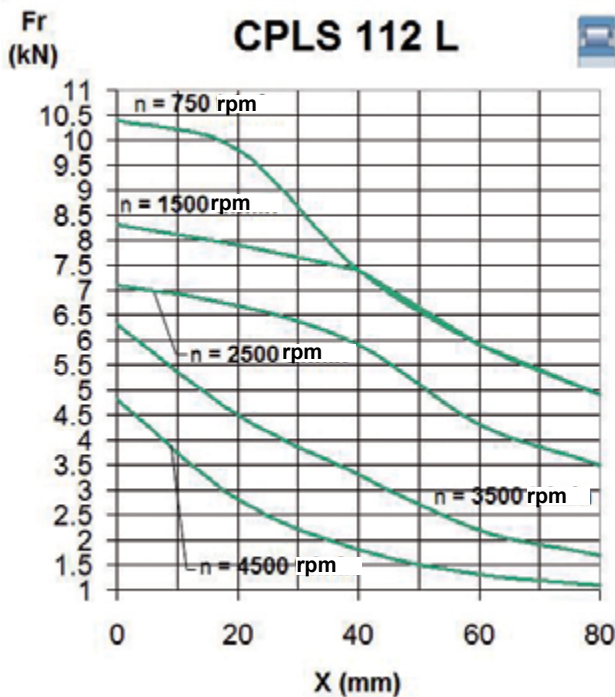
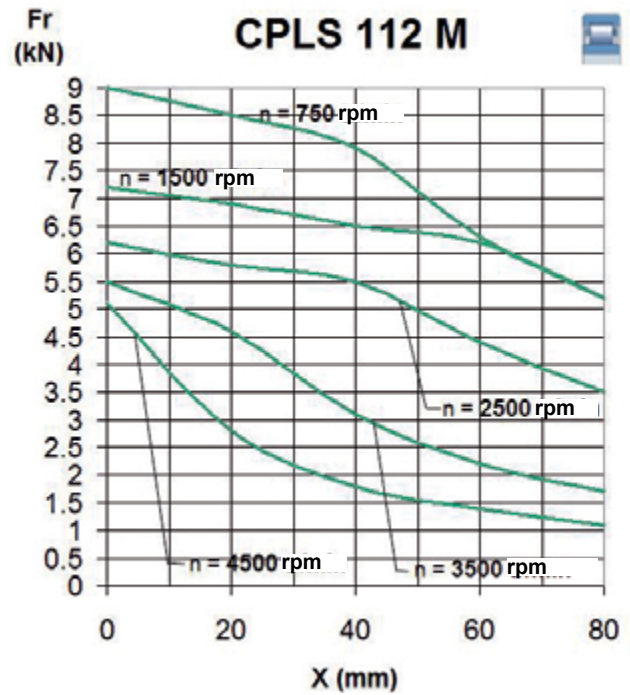
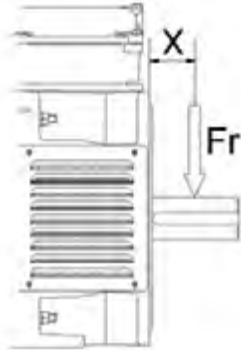

# CPLS

Asynchronous motors for variable frequency

General information

## Permissible radial loads (roller bearings)

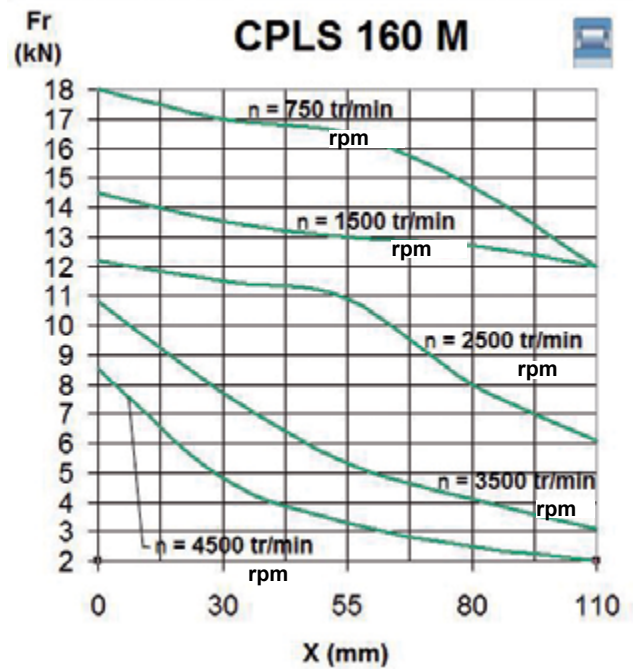
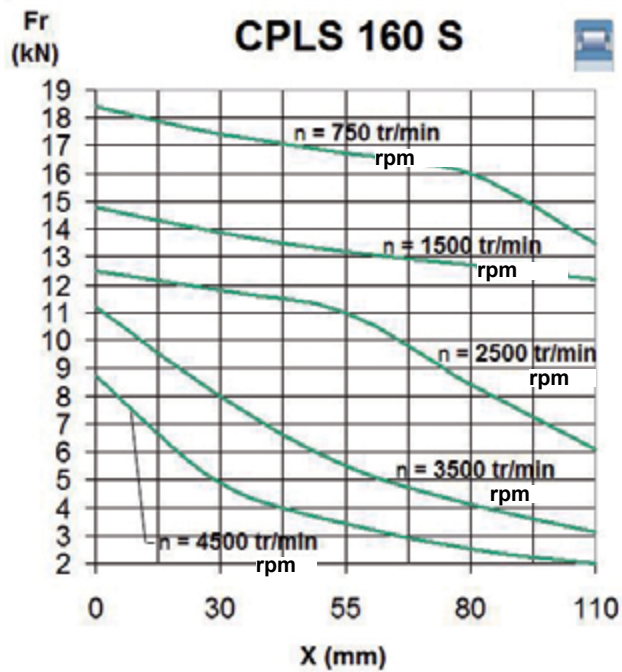
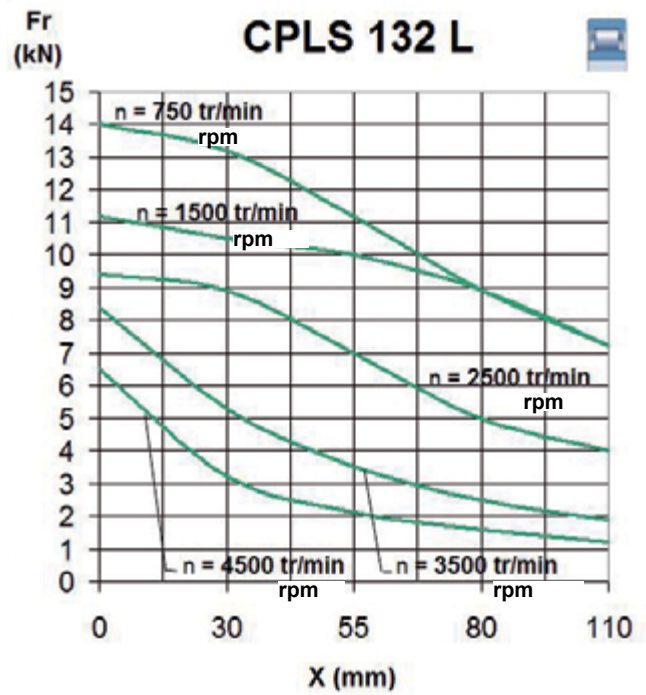
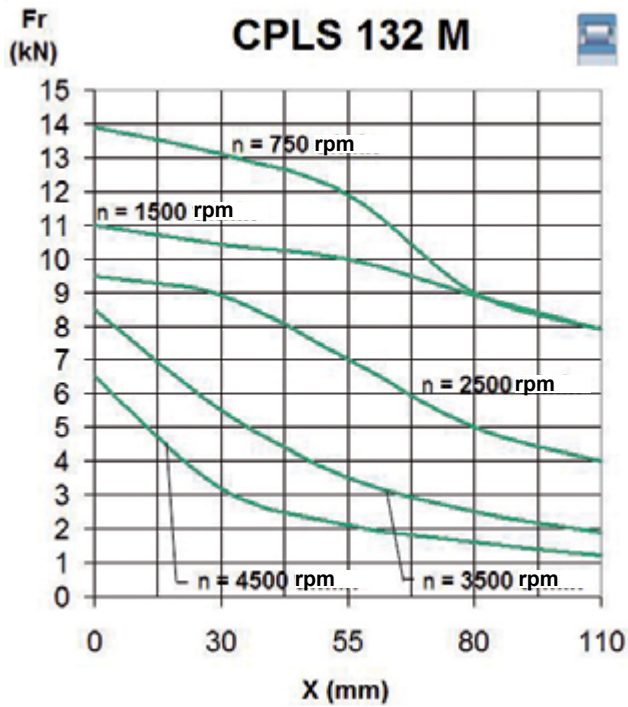



# CPLS

Asynchronous motors for variable frequency

General information

## Permissible radial loads (roller bearings)

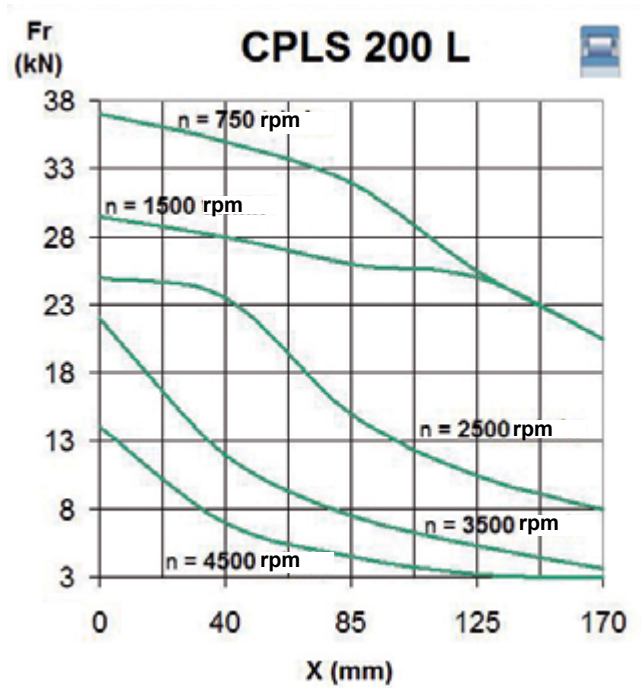
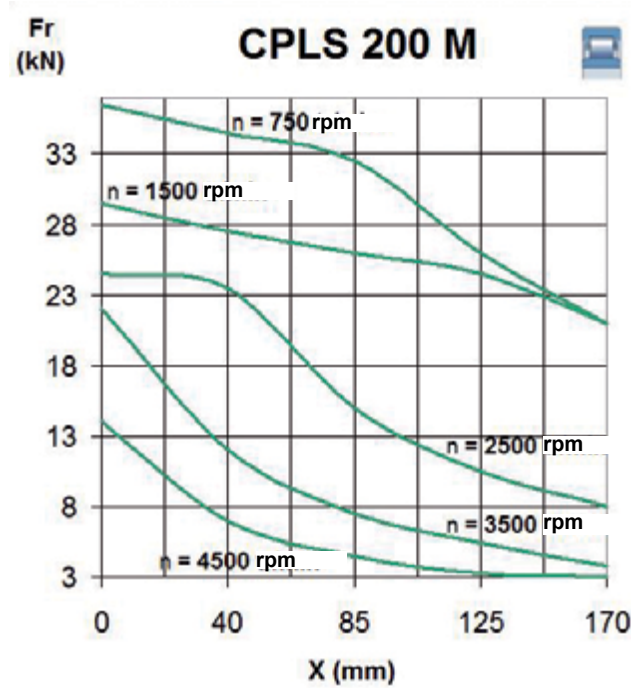
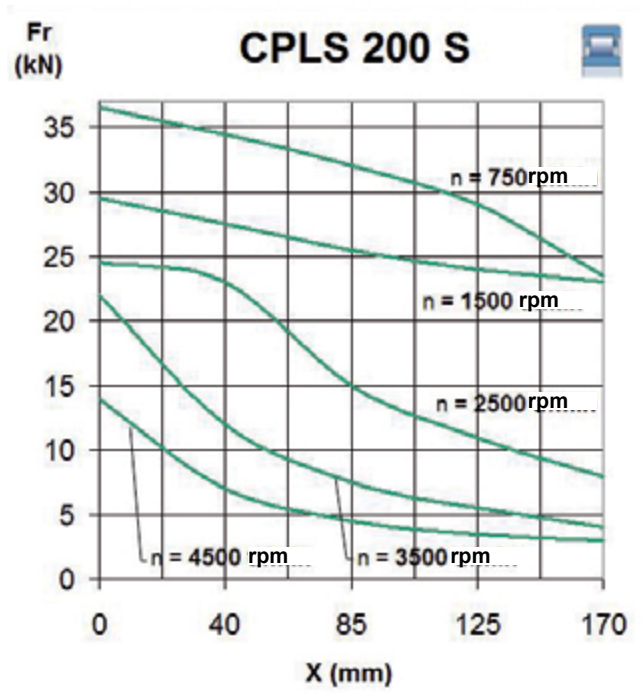
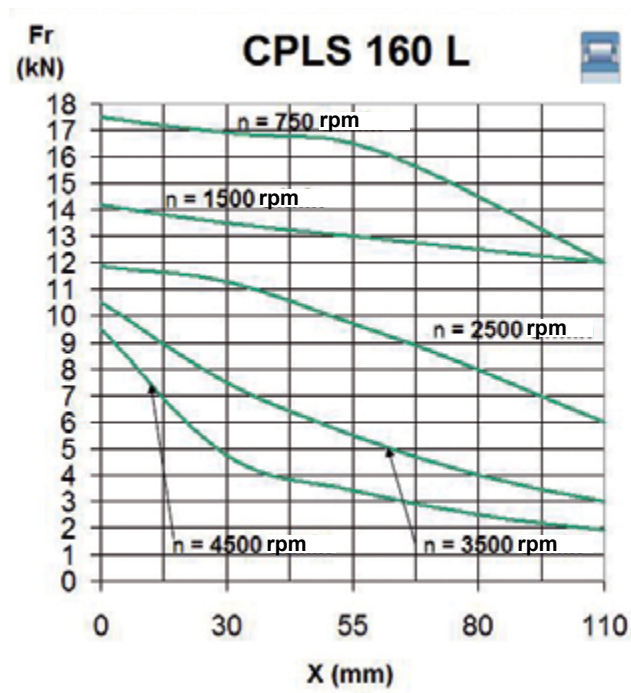

# CPLS

Asynchronous motors for variable frequency

General information

## Permissible radial loads (roller bearings)

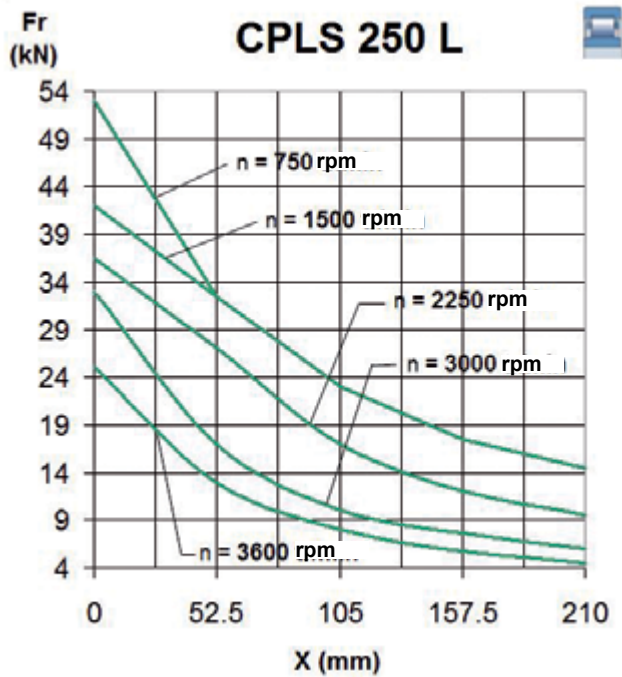
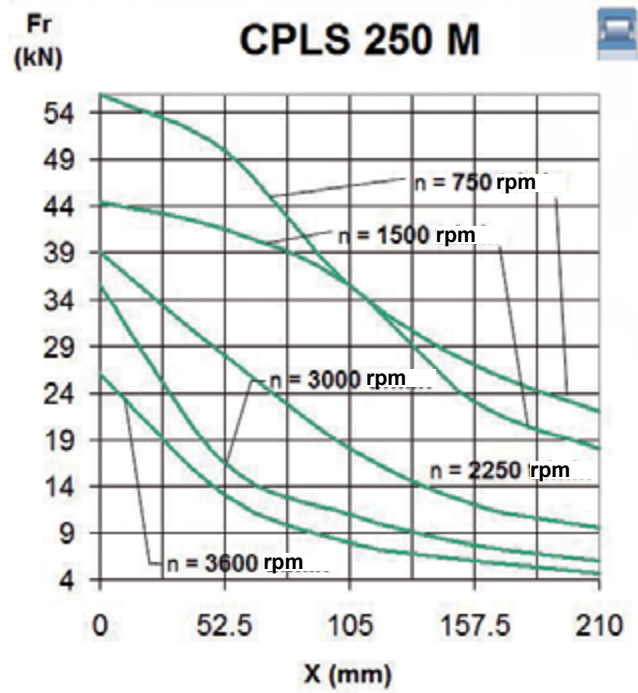
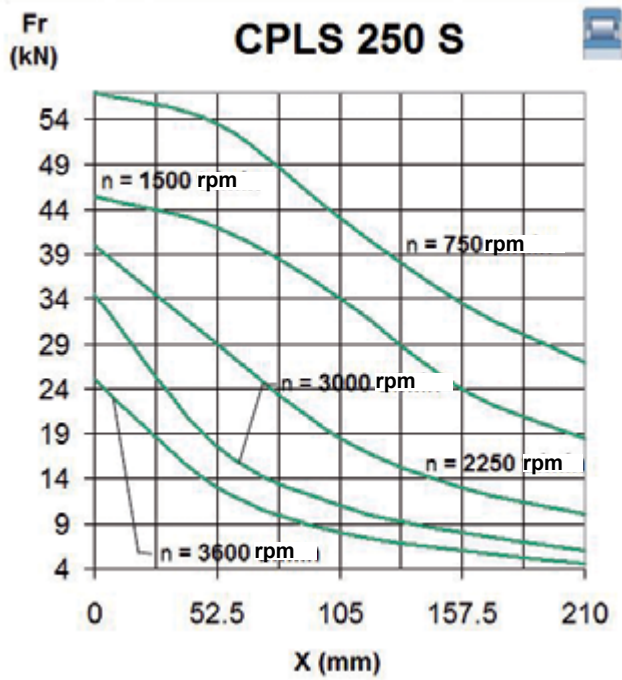

# CPLS

## Asynchronous motors for variable frequency

### General information

### Noise and vibration

#### NOISE LEVEL

Standard IEC 6034-9 defines maximum noise levels for rotary electrical machinery. However, these values do not apply to ac machines supplied by frequency converters.

The values below are therefore given for indication purposes only.

#### Noise level (indicative) expressed as acoustic pressure Lp(A)

Type	No load dbA	Under load dbA
CPLS 112 CPLS 132	75	79
CPLS 160	80	84
CPLS 200	82	86
CPLS 250	84	88

Tolerance: 0 / + 3 dbA

Maximum frequency: 100 Hz

#### Noise level reduction

For instances requiring lower noise levels, cooling mode IC 37 can be chosen, allowing ventilation to be installed in a less sensitive area.

For duty cycles  $\leq 60\%$ , it is possible to fit 4-pole FV motors instead of 2-pole (please enquire).

Quotations can be issued for sound traps. Noise is reduced by 5 db(A) to 10 db(A) (depending on the type of CPLS).

#### MACHINE VIBRATION LEVELS

#### Maximum vibration magnitude limits in terms of displacement, speed and acceleration for a frame size H (IEC 60034-14)

Vibration level	Frame size H (mm)					
	CPLS 112 AND 132			CPLS 160 / 200 / 250		
	Displacement $\mu\text{m}$	Speed $\text{mm/s}$	Acceleration $\text{m/s}^2$	Displacement $\mu\text{m}$	Speed $\text{mm/s}$	Acceleration $\text{m/s}^2$
A	25	1.6	2.5	35	2.2	3.5
B	11	0.7	1.1	18	1.1	1.7

# CPLS

## Asynchronous motors for variable frequency

### General information

### External finishing

CPLS motors comply with System Ia requirements

LEROY-SOMER motors are protected with a range of surface finishes. Surfaces receive appropriate special treatments, as shown below.

#### Preparation of surfaces

Surface	Parts	Surface treatment
Cast iron	Shields - Terminal box	Shot blasting + Primer
Steel	Accessories	Phosphate treatment + Primer
	Shields - Terminal boxes - Fan covers - Grilles	Electrophoresis or Hydrofour Flow coat
Aluminium alloy	FV motor housings - Terminal boxes	Shot blasting
	End shields	Phosphate treatment
Polymer	Fan covers - Terminal boxes Ventilation grilles (FV motor)	None, but must be free from grease, casting-mould coatings, and dust which would affect paint adhesion

#### Paint systems

Products	Environment	System	Applications
Moteurs Leroy-Somer	Low aggression or non-aggressive, temperate climate	Ia	1 polyurethane - vinyl top coat 25/30 µm
	Damp, tropical climate	IIa	1 Epoxy base coat 30-40 µm 1 polyurethane - vinyl top coat 25/30 µm
	Coastal	IIIa	1 Epoxy base coat 30-40 µm 1 Epoxy intermediate coat 30-40 µm 1 polyurethane - vinyl top coat 25/30 µm
	Chemical, aggressive or particular marine	Special systems (please consult Leroy-Somer)	Navy - Nuclear Significant contact with alkali or acid, etc.

System Ia is for moderate climates and System IIa is for general climates as defined in standard NFC 20 000 (or IEC 721.2.1).

Leroy-Somer standard paint colour reference:

**RAL 6000**

# CPLS

## Asynchronous motors for variable frequency

### General information

## High Speed Configuration

To satisfy applications running at high speeds, several configurations (HV1, HV2, HV3) were defined according to the size of the CPLS and the speeds achievable.

The graph below details the various maximum speeds achievable.

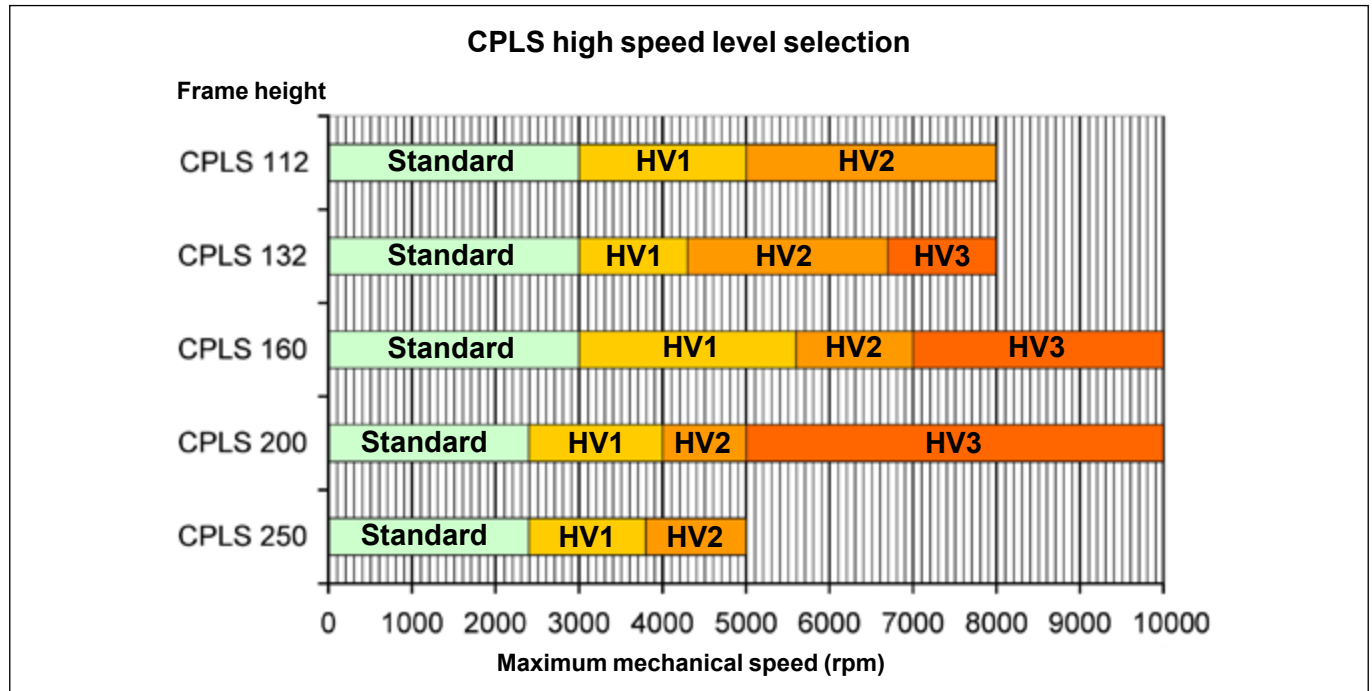

CPLS 160 L, CPLS 200 L, CPLS 250 L, limited to 5,000, 4,500 and 3,800 min<sup>-1</sup> respectively.

The table below explains the detail of each configuration.

	CPLS 112		CPLS 132			CPLS 160 <sup>1</sup>			CPLS 200 <sup>2</sup>			CPLS 250 <sup>3</sup>	
	HV1	HV2	HV1	HV2	HV3	HV1	HV2	HV3	HV1	HV2	HV3	HV1	HV2
Maximum speed (rpm)	3000-5000	5000-8000	3000-4300	4300-6700	6700-8000	3000-5600	5600-7000	7000-10000	2400-4000	4000-5000	5000-10000	2400-3800	3800-5000
Sealed bearings (2RS)	●		●										
Protected bearings (2Z)		●		●	●	●			●				
Open bearings							●	●		●	●	●	●
High speed bearings					●			●			●		
DE insulated bearing	●	●	●	●	●	●	●	● <sup>4</sup>	●	●	● <sup>4</sup>	●	●
NDE insulated bearing	●	●	●	●	●	●	●	● <sup>4</sup>	●	●	● <sup>4</sup>	●	●
Re-greasing system							●	●		●	●	●	●
High performance grease					●		●	●		●	●	●	●
Bearing temperature sensor		●		●	●		●	●			●		
Enhanced balancing	●	●	●	●	●	●	●	●	●	●	●	●	●
Vibration control		●		●	●		●	●		●	●		●
Speed encoder adaptation > 6000 min <sup>-1</sup>		●		●	●		●	●			●		
Max shaft diameter (mm)	38	38	48	48	48	55	55	55	80	80	65	100	80

●: standard      ●: option

1. CPLS 160 L limited to 5000 rpm

CPLS 200 L limited to 4500 rpm

3. CPLS 250 L limited to 3800 rpm

4. limited to 8500 rpm

In the standard configuration, the bearings are 2RS sealed type, except for the CPLS 250 which are open bearings.

# CPLS

## Asynchronous motors for variable frequency

### General information

### Complete description

---

## CPLS-112L-0606-IM1001-B1-F-B-R-HV1

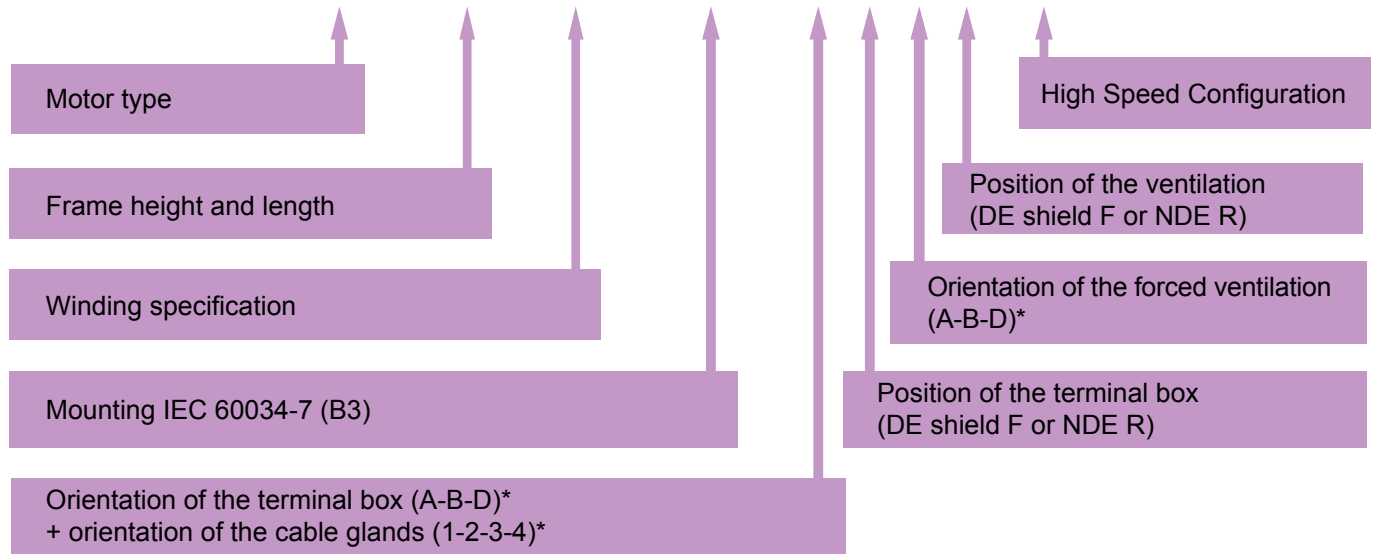

\* For more information, see pages 52 and 53.

# CPLS

## Asynchronous motors for variable frequency

### Electrical characteristics

#### Choice of motor

To assist you in quickly determining your motor/drive assembly, we have produced sizing data sheets dedicated to variable speed.

**a** – Initially, you must determine the nominal usable torque required by your application. The necessary torque ( $M_N$ ) at the nominal point ( $n_1$ ) defines the size of the machine in the range. The range of iso-power curves opposite allow you to make an initial approach to choose the size of the machine.

**b** – In the data sheet corresponding to the motor torque selected, the speed closest to that required is chosen, in accordance with the voltage available at the output from the drive.

This choice determines the type of

machine, i.e. the most suitable winding that will allow you to use the drive rating closest to your needs. That is indicated in the selection sheet.

This selection method allows you to size the motor/drive assembly corresponding to the actual need of the application.

An example of selection is given on page 23.

Our machines are tested on test benches by **Leroy-Somer** range drives. Where available, these characteristics may be requested from the factory.

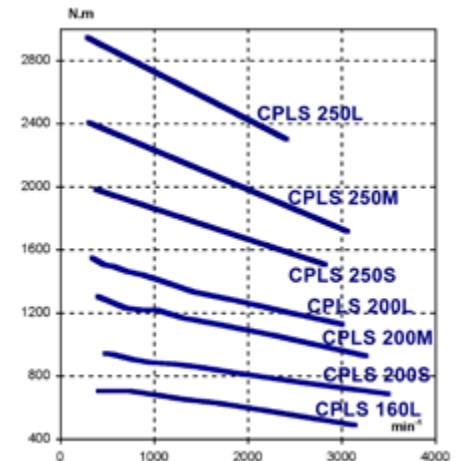
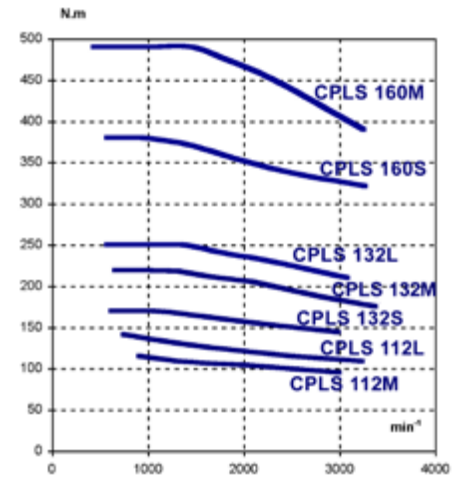

#### Choice of drive

Depending on the application, the nominal power of the machine and the rating of the machine drive may be different.

If you are working from zero speed to machine speed  $n_1$ , you should choose the drive rating corresponding to the machine's rated current.

Our range of machines offers as standard a constant power range going up to twice the nominal speed ( $n_2$ ) without having to de-rate the drive.

Thereafter, the operating power is reduced because of the rapid reduction in the maximum torque in asynchronous motors.

**⚠ TAKE CARE to check that the machine bearings are capable of operating at the high speeds you require** (see page 20).

**⚠ TAKE CARE to select a drive switching frequency equal at least to 12 times the motor's supply frequency.**

Full documentation on electronic drives in the DIGIDRIVE-SK, UNIDRIVE-SP and POWERDRIVE ranges is available from our representative on request.

If you wish to increase the speed ratio  $n_2/n_1$  you can use our patented **CONSTANT POWER SYSTEM**. It can be integrated in the terminal box, and makes it possible to operate over a wider speed range without de-rating the drive.



# CPLS

## Asynchronous motors for variable frequency

### Electrical characteristics

### Selection example

To make the selection you need to know the torque required by your application. If the torque is known, go directly to step no. 3.

*Example: I have an application which requires 6kW at 1200 min<sup>-1</sup> in S1 service.*

*The ambient temperature will be +20°C in operation, altitude lower than 1000 m.*

*The terminal box must be on the right hand side and the fan on the top of the machine when looking at the end of the shaft.*

#### Step 1: Correction factors

- Correction depending on the temperature and altitude (page 7).
- Correction depending on the service (page 7).

*Example: there is no need to de-rate to take the service or environmental conditions into account.*

#### Step 2: Calculation of rated torque

You know the power and the speed; you can calculate the torque using the formula:

$$C = P \times 9550/n$$

C: torque in N.m

P: power in kW

n: speed in min<sup>-1</sup>

*Example: the torque required for my application is 127 N.m*

#### Step 3: Determining the frame size

The diagram on page 22 allows the size of the machine to be determined quickly from the torque and the speed.

*Example: from the graph on page 22, I select machine CPLS 112 L*

#### Step 4: Determining the machine

On the sheet for the machine you choose, depending on the voltage available on output from your drive, the closest speed or the next one above the one you need.

From the selected line, you obtain main mechanical and electrical parameters that define your operating point, as well as the size of the drive and the machine product code.

*Example:*

*See the technical sheet for motor CPLS 112 L.*

*For a voltage at the output from the drive of 360V.*

*The next speed up from the one I need is 1215 min<sup>-1</sup>.*

#### Step 5: Verification

The machine torque that appears on the line is the one obtained in S1 service. I check that it is equal to or greater than the one I need.

If that is not the case, I move up to the next machine size.

*Example: the motor torque in S1 service is 130 N.m for a need of 127 N.m; the machine size is correct.*

*Motor arrangement selected:*

*Motor: CPLS 112 L 0606 B1F AR*

*Drive: UNIDRIVE SP 27T*

**! WARNING: you must specify the maximum operating speed, as the choice of bearings depends on this.**



**UNIDRIVE SP**



**CPLS**  
**Asynchronous motors for variable frequency**  
**Electrical characteristics**  
**Selection tables**

**CPLS 112M / 95 - 115 N.m**

Motor IP23 – Ventilation IC06 – Class F  
 Service S1 – Ambient temperature 40°C – Total mass: 87 kg  
 Inertia: 0.030 kg.m<sup>2</sup> - Maximum mechanical speed: 8000 min<sup>-1</sup>  
 0.37 kW forced ventilation – 230/400V 50Hz

P (kW)	U (V)*	F(Hz)	n <sub>1</sub> (min <sup>-1</sup> )	T (N.m)	I (A)	cos φ	η (%)	R (Ω) (1)	n <sub>2</sub> (min <sup>-1</sup> )	CPLS	UNIDRIVE SP (Inominal / Heavy overload)	
											LS	CT
8.5	320	25.9	714	114	22.7	0.87	77	1.254	1365	112M0604	SP 16T (25A)	SP 2403 (25A)
9.1	340	27.5	762	114	22.7	0.86	78		1511			
9.7	360	29.1	812	114	22.8	0.86	79		1630			
10.3	380	30.7	860	114	22.8	0.85	80		1697			
11.0	400	32.3	908	115	23.0	0.85	81		1760			
12.0	440	35.5	1006	114	22.7	0.84	82		2083			
12.9	480	38.8	1107	111	22.3	0.83	83		2320			
11.7	320	36.1	1015	109	28.4	0.89	82	2000	0.754	112M0605	SP 22T (32A)	SP 3401 (32A)
12.5	340	38.3	1081	110	28.7	0.89	83	2122				
13.4	360	40.6	1151	110	28.6	0.89	83	2245				
14.2	380	42.8	1217	111	28.8	0.88	84	2410				
15.0	400	45.1	1312	109	28.5	0.89	85	2600				
16.1	440	49.6	1424	108	27.8	0.87	86	2853				
17.3	480	54.2	1564	106	27.3	0.87	87	3157				
14.6	320	46.1	1316	106	35.6	0.86	85	2851	0.492	112M0606	SP 27T (40A)	SP 3402 (40A)
15.6	340	49.0	1403	106	35.6	0.86	86	3061				
16.5	360	51.8	1488	106	35.5	0.85	87	3240				
17.5	380	54.7	1575	106	35.5	0.85	87	3428				
18.5	400	57.6	1663	106	35.6	0.85	88	3610				
20.4	440	63.4	1837	106	35.5	0.84	89	4170				
22.3	480	69.1	2009	106	35.5	0.84	89	4591				
17.5	320	55.7	1603	104	41.3	0.86	87	3475	0.35	112M0607	SP 33T (46A)	SP 3403 (46A)
18.6	340	59.2	1708	104	41.2	0.86	88	3719				
19.7	360	62.6	1811	104	41.1	0.86	89	4016				
20.9	380	66.1	1916	104	41.2	0.86	89	4367				
22.0	400	69.6	2021	104	41.1	0.85	90	4610				
24.3	440	76.6	2232	104	41.1	0.85	90	5092				
26.5	480	83.5	2440	104	41.0	0.85	91	5575				
23.8	320	81.6	2390	95	55.9	0.83	91	5940	0.163	112M0608	SP 40T (60A)	SP 4401 (60A)
25.3	340	86.7	2543	95	55.9	0.83	91	6330				
26.9	360	92.0	2702	95	56.0	0.83	92	6720				
28.4	380	97.0	2852	95	56.0	0.83	92	7110				
30.0	400	102	3002	95	56.2	0.83	92	7470				
32.9	440	117	3450	91	54.1	0.85	93	8000				
36.1	480	138	4075	84	52.3	0.88	93	8000				

\* voltage available on output from the drive

(1): Phase-to-phase resistance value

These indicative values are non-contractual and may be modified at any time by the manufacturer.

**CPLS**  
Asynchronous motors for variable frequency  
Electrical characteristics  
**Selection tables**

**CPLS 112L / 110 - 140 N.m**

Motor IP23 – Ventilation IC06 – Class F  
Service S1 – Ambient temperature 40°C – Total mass: 97 kg  
Inertia: 0.035 kg.m<sup>2</sup> - Maximum mechanical speed: 8,000 min<sup>-1</sup>  
0.37 kW forced ventilation – 230/400V 50Hz

P (kW)	U (V)*	F(Hz)	n <sub>1</sub> (min <sup>-1</sup> )	T (N.m)	I (A)	cos φ	η (%)	R (Ω) ( <sup>1</sup> )	n <sub>2</sub> (min <sup>-1</sup> )	CPLS	UNIDRIVE SP (Inominal / Heavy overload)	
											LS	CT
8.4	320	21.5	581	138	23.1	0.88	74	1.39	990	112L0604	SP 16T (25A)	SP 2403 (25A)
9.1	340	22.9	623	139	23.2	0.87	76		1130			
9.7	360	24.2	663	140	23.2	0.87	77		1245			
10.4	380	25.6	704	141	23.4	0.86	78		1385			
11.0	400	26.9	745	141	23.4	0.86	78		1480			
12.4	440	30	826	143	23.7	0.85	80		1680			
13.8	480	32.3	907	145	24.0	0.85	81		1905			
11.4	320	30.1	835	130	28.6	0.89	80	1562	0.836	112L0605	SP 22T (32A)	SP 3401 (32A)
12.2	340	32	893	130	28.5	0.89	81	1705				
13.1	360	33.8	947	132	28.7	0.89	82	1825				
14.0	380	35.7	1004	133	28.9	0.89	82	1970				
15.0	400	37.6	1060	135	29.2	0.88	83	2115				
16.6	440	41	1175	135	29.1	0.88	84	2330				
18.2	480	45.1	1287	135	29.1	0.88	85	2625				
14.5	320	37.9	1071	129	35.2	0.88	83	2132	0.540	112L0606	SP 27T (40A)	SP 3402 (40A)
15.6	340	40.3	1143	130	35.4	0.88	84	2302				
16.6	360	42.7	1215	130	35.4	0.88	85	2462				
17.5	380	45	1286	130	35.2	0.88	85	2606				
18.5	400	47.4	1358	130	35.1	0.88	86	2785				
20.4	440	52	1503	129	35.0	0.87	87	3147				
22.2	480	56.9	1645	129	34.8	0.87	88	3670				
17.3	320	46.4	1325	125	41.5	0.86	86	2715	0.388	112L0607	SP 33T (46A)	SP 3403 (46A)
18.5	340	49.3	1412	125	41.6	0.86	87	2978				
19.7	360	52.2	1499	125	41.6	0.86	87	3051				
20.8	380	55.1	1587	125	41.6	0.86	88	3507				
22.0	400	58	1674	125	41.6	0.86	88	3670				
24.2	440	64	1849	125	41.4	0.85	89	4027				
26.9	480	69.6	2022	127	41.9	0.85	90	4550				
23.8	320	68	1982	115	56.5	0.83	90	4917	0.180	112L0608	SP 40T (60A)	SP 4401 (60A)
25.3	340	72.2	2108	115	56.5	0.83	91	5220				
26.9	360	76.5	2237	115	56.5	0.83	91	5550				
28.4	380	80.7	2364	115	56.5	0.83	91	5820				
30.0	400	85	2493	115	56.6	0.83	92	6125				
33.1	440	94	2748	115	56.7	0.82	92	6814				
36.2	480	102	3003	115	56.7	0.82	92	7470				
29.5	320	88	2482	109	67.8	0.85	92	6415	0.114	112L0609	SP 50T (74A)	SP 4402 (74A)
31.2	340	93	2732	109	67.7	0.84	92	6780				
33.3	360	99	2912	109	67.8	0.84	92	7230				
35.0	380	104	3063	109	67.7	0.84	93	7621				
37.0	400	110	3242	109	67.7	0.84	93	8000				
40.8	440	121	3573	109	67.7	0.84	93	8000				
44.6	480	140	4140	103	65.5	0.87	94	8000				

\* voltage available on output from the drive

(<sup>1</sup>): Phase-to-phase resistance value

These indicative values are non-contractual and may be modified at any time by the manufacturer.

**CPLS**  
Asynchronous motors for variable frequency  
Electrical characteristics  
**Selection tables**

**CPLS 132S / 145 - 170 N.m**

Motor IP23 – Ventilation IC06 – Class F

Service S1 – Ambient temperature 40°C – Total mass: 125 kg

Inertia: 0.065 kg.m<sup>2</sup> - Maximum mechanical speed: 6,700 min<sup>-1</sup> (8,000 min<sup>-1</sup> with HV3 configuration)

0.37 kW forced ventilation – 230/400V 50Hz

P (kW)	U (V)*	F(Hz)	n <sub>1</sub> (min <sup>-1</sup> )	T (N.m)	I (A)	cos φ	η (%)	R (Ω) (1)	n <sub>2</sub> (min <sup>-1</sup> )	CPLS	UNIDRIVE SP (Inominal / Heavy overload)	
											LS	CT
8.6	320	18.2	480	171	24.2	0.87	74	1.358	671	132S0604	SP 16T (25A)	SP 2403 (25A)
9.2	340	19.4	517	170	24.1	0.86	76		821			
9.8	360	20.5	552	170	24.1	0.85	77		932			
10.4	380	21.7	588	169	24.0	0.85	78		1050			
11.0	400	22.8	617	170	24.3	0.83	79		1159			
12.3	440	25.1	692	170	24.2	0.83	80		1363			
13.5	480	27.4	761	170	24.3	0.82	82		1507			
11.7	320	24.2	657	170	30.6	0.88	79		1050			
12.6	340	25.8	705	171	30.7	0.88	80		1190			
13.4	360	27.3	751	170	30.6	0.87	81		1333			
14.2	380	28.8	797	170	30.5	0.87	82	1419				
15.0	400	30.3	842	170	30.5	0.86	82	1568				
16.6	440	33.6	942	168	30.2	0.86	84	1777				
18.2	480	37.2	1050	165	29.8	0.86	85	1986				
14.6	320	29.5	816	171	36.8	0.87	82	1452				
15.6	340	31.4	873	170	36.8	0.87	83	1570				
16.5	360	33.2	929	170	36.6	0.86	84	1743				
17.6	380	35.1	985	170	36.7	0.86	84	1862				
18.5	400	36.9	1040	170	36.6	0.86	85	2058				
20.5	440	42.0	1192	164	35.7	0.87	87	2245				
22.4	480	46.7	1333	160	35.1	0.88	88	2491				
17.3	320	35.2	981	168	43.4	0.86	84	1658				
18.4	340	37.4	1048	168	43.2	0.85	85	1886				
19.6	360	39.6	1114	168	43.2	0.85	86	2008				
20.6	380	41.2	1165	169	43.4	0.84	86	2193				
22.0	400	44.0	1247	168	43.3	0.84	87	2358				
24.2	440	49.0	1398	165	42.6	0.85	88	2631				
26.7	480	54	1547	165	42.5	0.85	89	2900				
23.8	320	49.6	1416	160	57.1	0.85	88	2690				
25.3	340	52.7	1510	160	56.9	0.85	89	2982				
26.9	360	55.8	1603	160	57.0	0.84	90	3163				
28.4	380	58.9	1697	160	56.9	0.84	90	3373				
30.0	400	62.0	1790	160	56.9	0.84	90	3554				
33.1	440	68.2	1976	160	56.9	0.84	91	3945				
36.2	480	75.5	2195	157	56.1	0.84	92	4336				
29.5	320	64	1851	152	68.7	0.85	91	3675				
31.4	340	68.0	1971	152	68.6	0.85	91	3916				
33.3	360	72.0	2091	152	68.6	0.85	92	4353				
35.2	380	76.0	2211	152	68.6	0.85	92	4623				
37.0	400	80.0	2332	152	68.4	0.85	92	4866				
40.9	440	89.0	2601	150	67.9	0.85	93	5433				
44.7	480	99.0	2902	145	65.9	0.86	93	6063				
35.9	320	81.6	2378	144	80.6	0.87	92	4720				
38.2	340	86.7	2531	144	80.5	0.87	93	5021				
40.5	360	91.8	2684	144	80.5	0.87	93	5578				
42.8	380	96.9	2837	144	80.5	0.87	93	5908				
45.0	400	102	2991	144	80.3	0.86	94	6239				
49.7	440	118	3468	135	77.4	0.88	94	6903				
51.0	480	128	3773	129	74.0	0.88	95	7519				

\* voltage on output from the drive

(1): Phase-to-phase resistance value

These indicative values are non-contractual and may be modified at any time by the manufacturer.

**CPLS**  
Asynchronous motors for variable frequency  
Electrical characteristics  
**Selection tables**

**CPLS 132M / 175 - 220 N.m**

Motor IP23 – Ventilation IC06 – Class F  
Service S1 – Ambient temperature 40°C – Total mass: 143 kg  
Inertia: 0.082 kg.m<sup>2</sup> - Maximum mechanical speed: 6,700 min<sup>-1</sup> (8,000 min<sup>-1</sup> with HV3 configuration)  
0.37 kW forced ventilation – 230/400V 50Hz

P (kW)	U (V)*	F(Hz)	n <sub>1</sub> (min <sup>-1</sup> )	T (N.m)	I (A)	cos φ	η (%)	R (Ω) ( <sup>1</sup> )	n <sub>2</sub> (min <sup>-1</sup> )	CPLS	UNIDRIVE SP (Inominal / Heavy overload)	
											LS	CT
11.7	320	19.1	507	220	31.5	0.88	76	904	777	132M0605	SP 22T (32A)	SP 3401 (32A)
12.6	340	20.3	544	221	31.6	0.87	78		889			
13.4	360	21.5	581	220	31.5	0.87	79		1002			
14.2	380	22.7	618	219	31.4	0.86	80		1101			
15.0	400	23.9	654	219	31.3	0.86	81		1166			
16.7	440	26.3	727	219	31.4	0.85	82		1369			
18.4	480	28.7	800	219	31.5	0.84	83		1505			
14.5	320	23.1	630	220	38.0	0.86	80	1123	132M0606	SP 27T (40A)	SP 3402 (40A)	
15.6	340	24.6	675	220	38.1	0.86	81	1266				
16.6	360	26.0	717	220	38.1	0.85	82	1417				
17.5	380	27.5	763	219	37.9	0.85	83	1509				
18.5	400	28.9	806	219	37.9	0.84	84	1596				
20.6	440	31.8	893	220	38.1	0.84	85	1771				
22.6	480	34.7	981	220	38.1	0.83	86	1947				
16.6	320	26.0	720	220	43.6	0.83	82	1424	132M0607	SP 33T (46A)	SP 3403 (46A)	
18.4	340	28.7	796	221	43.6	0.86	83	1495				
19.6	360	30.4	848	221	43.6	0.86	84	1674				
20.8	380	32.1	899	221	43.6	0.86	85	1778				
22.0	400	33.8	950	221	43.6	0.85	85	1881				
24.3	440	37.2	1053	220	43.5	0.85	86	2088				
26.3	480	41.0	1168	215	42.6	0.85	87	2319				
22.6	320	36.8	1036	218	59.3	0.83	86	2050	132M0608	SP 40T (60A)	SP 4401 (60A)	
25.2	340	39.1	1105	218	59.4	0.83	87	2189				
26.8	360	41.4	1175	218	59.4	0.83	87	2439				
28.4	380	43.7	1244	218	59.5	0.82	88	2587				
30.0	400	46.0	1313	218	59.5	0.82	89	2745				
33.1	440	50.6	1452	218	59.5	0.82	89	3045				
36.2	480	56.0	1614	214	58.6	0.82	90	3208				
29.3	320	46.4	1324	211	71.1	0.84	89	2632	132M0609	SP 50T (74A)	SP 4402 (74A)	
31.2	340	49.3	1412	211	71.1	0.84	89	2813				
33.1	360	52.2	1499	211	71.0	0.83	90	3131				
35.0	380	55.1	1587	211	71.0	0.83	90	3313				
37.0	400	58.0	1673	211	71.1	0.83	91	3549				
40.8	440	65.0	1883	207	69.9	0.84	91	3744				
44.6	480	72.3	2101	203	68.7	0.85	92	4190				
35.6	320	57.6	1657	205	82.4	0.86	90	3280	132M0610	SP 60T (96A)	SP 4403 (96A)	
37.9	340	61.2	1765	205	82.3	0.86	91	3503				
40.2	360	64.8	1874	205	82.2	0.86	91	3731				
42.5	380	68.4	1982	205	82.2	0.86	92	4109				
45.0	400	72.0	2090	205	82.5	0.86	92	4347				
49.5	440	81.7	2380	198	80.5	0.87	93	4745				
54.1	480	93.5	2730	189	78.6	0.89	93	5422				
43.8	320	76.8	2234	187	97.2	0.88	93	4449	132M0611	SP 75T (124A)	SP 5401 (124A)	
46.6	340	81.6	2378	187	97.1	0.88	93	4749				
49.4	360	86.4	2522	187	97.1	0.87	93	5021				
52.2	380	91.2	2667	187	97.0	0.87	93	5577				
55.0	400	96.0	2811	187	97.0	0.87	94	5878				
60.7	440	114	3345	173	94.5	0.90	94	6650				
62.0	480	118	3475	171	89.9	0.88	95	6851				
49.3	320	92.0	2690	175	107.2	0.89	94	5349	132M0612	SP 75T (124A)	SP 5401 (124A)	
52.5	340	97.8	2864	175	107.2	0.89	94	5964				
55.6	360	103.5	3036	175	107.1	0.89	94	6325				
58.8	380	109.3	3210	175	107.0	0.89	94	6715				
62.0	400	115	3380	175	107.0	0.88	94	7075				
64.0	440	131	3864	158	99.5	0.89	95	7700				
66.0	480	143	4228	149	94.1	0.89	95	8000				

\* voltage available on output from the drive (1): Phase-to-phase resistance value

These indicative values are non-contractual and may be modified at any time by the manufacturer.

**CPLS**  
Asynchronous motors for variable frequency  
Electrical characteristics  
**Selection tables**

**CPLS 132L / 210 - 250 N.m**

Motor IP23 – Ventilation IC06 – Class F

Service S1 – Ambient temperature 40°C – Total mass: 174 kg

Inertia: 0.107 kg.m<sup>2</sup> - Maximum mechanical speed: 6,700 min<sup>-1</sup> (8,000 min<sup>-1</sup> with HV3 configuration)

0.37 kW forced ventilation – 230/400V 50Hz

P (kW)	U (V)*	F(Hz)	n <sub>1</sub> (min <sup>-1</sup> )	T (N.m)	I (A)	cos φ	η (%)	R (Ω) ( <sup>1</sup> )	n <sub>2</sub> (min <sup>-1</sup> )	CPLS	UNIDRIVE SP (Inominal / Heavy overload)	
											LS	CT
11.5	320	16.7	445	247	30.9	0.87	76	912	712	132L0605	SP 22T (32A)	SP 3401 (32A)
12.4	340	17.8	478	248	31.0	0.87	78		797			
13.2	360	18.8	509	248	30.9	0.86	79		909			
14.1	380	19.9	542	248	31.0	0.86	80		1021			
15.0	400	20.9	572	250	31.2	0.86	80		1083			
16.6	440	23.0	636	249	31.0	0.85	82		1257			
18.3	480	25.1	700	250	31.1	0.85	83		1385			
14.4	320	20.2	551	250	37.6	0.86	80		1049			
15.5	340	21.5	590	250	37.8	0.86	81		1163			
16.5	360	22.8	630	250	37.7	0.86	82		1253			
17.4	380	24.0	666	250	37.7	0.85	82	1380				
18.5	400	25.3	705	250	37.7	0.85	83	1462				
20.4	440	27.8	781	250	37.7	0.84	84	1548				
22.5	480	30.4	860	250	37.6	0.84	85	1706				
17.2	320	23.8	659	249	43.7	0.86	82	1311				
18.4	340	25.2	702	250	43.8	0.85	83	1455				
19.6	360	26.7	745	250	43.8	0.85	84	1547				
20.7	380	28.2	792	250	43.9	0.85	85	1718				
22.0	400	29.7	837	250	43.8	0.84	85	1818				
24.3	440	32.7	928	250	43.7	0.84	86	2022				
26.6	480	35.6	1016	250	43.7	0.84	87	2205				
23.7	320	32.0	906	250	58.3	0.85	86	2040				
25.3	340	34.0	967	250	58.4	0.84	87	2190				
26.9	360	36.0	1027	250	58.4	0.84	87	2340				
28.5	380	38.0	1087	250	58.5	0.84	88	2463				
30.0	400	40.0	1147	250	58.4	0.84	88	2613				
33.2	440	45.0	1297	244	57.4	0.85	89	2968				
35.8	480	51.0	1476	232	55.3	0.86	90	3466				
29.2	320	39.4	1126	247	72.6	0.82	88	2572				
31.2	340	41.8	1199	248	72.7	0.81	89	2725				
33.3	360	44.3	1273	249	73.1	0.81	90	2959				
35.1	380	46.7	1346	249	73.2	0.81	90	3194				
37.0	400	49.2	1421	249	73.1	0.81	90	3376				
40.9	440	54.1	1568	249	73.2	0.80	91	3709				
44.7	480	59.0	1716	249	73.3	0.80	91	4070				
35.7	320	49.2	1419	240	85.6	0.83	90	3229				
38.0	340	52.3	1513	240	85.5	0.83	91	3440				
40.3	360	55.3	1603	240	85.6	0.82	91	3652				
42.6	380	58.4	1696	240	85.5	0.82	91	3863				
45.0	400	61.5	1790	240	85.7	0.82	92	4073				
49.6	440	67.6	1973	240	85.7	0.82	92	4692				
53.0	480	75.0	2195	230	82.7	0.83	93	5235				
43.4	320	62.4	1810	229	98.1	0.86	92	3937				
46.4	340	66.3	1927	230	98.5	0.86	92	4179				
49.2	360	70.2	2044	230	98.4	0.86	92	4448				
52.0	380	74.1	2161	230	98.5	0.86	93	4718				
55.0	400	78.0	2279	230	98.6	0.86	93	4959				
60.5	440	85.8	2513	230	98.3	0.86	93	5471				
64.0	480	95.0	2790	219	94.7	0.86	94	6363				
54.1	320	84.0	2458	210	119	0.87	93	5314				
57.6	340	89.3	2617	210	119	0.87	93	5702				
61.0	360	94.5	2773	210	119	0.87	94	6062				
64.4	380	99.8	2932	210	119	0.87	94	6423				
68.0	400	105	3088	210	119	0.87	94	6754				
70.0	440	115.5	3408	196	111	0.87	94	7610				
72.0	480	126	3727	185	105	0.86	95	8000				

\* voltage available on output from the drive (<sup>1</sup>): Phase-to-phase resistance value

These indicative values are non-contractual and may be modified at any time by the manufacturer.

**CPLS**  
Asynchronous motors for variable frequency  
Electrical characteristics  
**Selection tables**

**CPLS 160S / 325 - 380 N.m**

Motor IP23 – Ventilation IC06 – Class F  
Service S1 – Ambient temperature 40°C – Total mass: 230 kg  
Inertia: 0.188 kg.m<sup>2</sup> - Maximum mechanical speed: 7,000 min<sup>-1</sup> (10000 min<sup>-1</sup> with HV3 configuration)  
1.1 kW forced ventilation – 230/400V 50Hz

P (kW)	U (V)*	F(Hz)	n <sub>1</sub> (min <sup>-1</sup> )	T (N.m)	I (A)	cos φ	η (%)	R (Ω) ( <sup>1</sup> )	n <sub>2</sub> (min <sup>-1</sup> )	CPLS	UNIDRIVE SP (Inominal / Heavy overload)	
											LS	CT
17.2	320	16.4	444	369	45	0.87	78	520	1000	160S0602	SP 33T (46A)	SP 3403 (46A)
18.3	340	17.4	475	367	45	0.86	80		1100			
19.6	360	18.5	509	368	45	0.86	80		1150			
20.8	380	19.5	539	368	45	0.86	81		1250			
22.0	400	20.5	572	367	45	0.86	82		1300			
24.3	440	22.6	633	367	45	0.85	84		1500			
26.7	480	24.6	694	366	45	0.84	85		1650			
23.7	320	22.0	613	368	59	0.87	83	1500	160S0603	SP 40T (60A)	SP 4401 (60A)	
25.2	340	23.4	655	367	59	0.86	84	1600				
26.8	360	24.8	697	367	59	0.86	85	1700				
28.4	380	26.1	737	368	59	0.86	85	1800				
30.0	400	27.5	779	368	59	0.85	86	1900				
33.2	440	30.3	864	367	59	0.85	87	2100				
36.4	480	33.0	945	368	59	0.84	88	2350				
29.2	320	26.0	734	380	74	0.85	85	1900	160S0604	SP 50T (74A)	SP 4402 (74A)	
31.2	340	27.6	782	381	74	0.84	86	2000				
33.1	360	29.0	825	383	74	0.83	86	2100				
35.1	380	30.9	881	380	74	0.84	87	2250				
37.0	400	32.5	930	380	74	0.83	87	2400				
40.8	440	35.8	1030	378	74	0.83	88	2650				
44.8	480	39.0	1125	380	74	0.82	89	2950				
35.6	320	31.6	903	377	88	0.84	87	2350	160S0605	SP 60T (96A)	SP 4403 (96A)	
38.0	340	33.6	963	377	88	0.84	88	2500				
40.3	360	35.6	1024	376	88	0.83	88	2650				
42.7	380	37.5	1080	377	88	0.83	89	2810				
45.0	400	39.5	1140	377	88	0.82	89	3100				
49.7	440	43.5	1260	376	88	0.82	90	3450				
53.0	480	49.0	1426	355	83	0.85	90	4150				
43.7	320	40.2	1159	360	101	0.88	89	2850	160S0606	SP 75T (124A)	SP 5401 (124A)	
46.6	340	42.8	1237	360	101	0.87	90	3050				
49.5	360	45.3	1312	360	101	0.87	90	3250				
52.3	380	47.8	1387	360	101	0.87	91	3450				
55.0	400	50.3	1462	360	101	0.87	91	3700				
57.9	440	55.4	1618	342	96	0.86	91	4200				
61.0	480	60.4	1770	329	94	0.86	92	5000				
59.6	320	55.8	1625	350	140	0.83	92	4500	160S0607	SP 100T (156A)	SP 5402 (156A)	
63.4	340	59.3	1730	350	140	0.83	92	4800				
67.3	360	62.8	1835	350	140	0.83	92	5000				
71.1	380	66.3	1943	350	140	0.83	93	5200				
75.0	400	69.8	2045	350	140	0.83	93	5500				
80.5	440	76.8	2256	341	137	0.82	93	6700				
85.5	480	83.8	2468	331	134	0.82	94	7350				
73.3	320	69.6	2036	344	165	0.86	93	5050	160S0608	SP 120T (180A)	SP 6401 (180A)	
77.9	340	74.0	2168	343	165	0.86	93	5400				
82.7	360	78.3	2297	344	165	0.86	94	5700				
85.5	380	82.7	2428	336	162	0.86	94	6050				
90.0	400	87.0	2560	336	162	0.85	94	6350				
94.0	440	95.7	2824	318	154	0.85	94	7360				
98.0	480	104	3087	303	148	0.84	95	8000				
88.8	320	88.8	2608	325	190	0.89	94	6450	160S0609	SP 150T (210A)	SP 6402 (210A)	
94.3	340	94.3	2773	325	190	0.89	94	6850				
100	360	99.9	2941	325	190	0.89	94	7300				
105	380	105	3095	324	190	0.89	95	7600				
110	400	111	3275	321	188	0.89	95	8000				
115	440	122	3609	305	179	0.89	95	8000				
-	-	-	-	-	-	-	-	-				-

\* voltage available on output from the drive (<sup>1</sup>): Phase-to-phase resistance value

These indicative values are non-contractual and may be modified at any time by the manufacturer.

# CPLS

## Asynchronous motors for variable frequency

### Electrical characteristics

### Selection tables

## CPLS 160M / 390 - 490 N.m

Motor IP23 – Ventilation IC06 – Class F

Service S1 – Ambient temperature 40°C – Total mass: 289 kg

Inertia: 0.246 kg.m<sup>2</sup> - Maximum mechanical speed: 7,000 min<sup>-1</sup> (10000 min<sup>-1</sup> with HV3 configuration)

1.1 kW forced ventilation – 230/400V 50Hz

P (kW)	U (V)*	F(Hz)	n <sub>1</sub> (min <sup>-1</sup> )	T (N.m)	I (A)	cos φ	η (%)	R (Ω) (1)	n <sub>2</sub> (min <sup>-1</sup> )	CPLS	UNIDRIVE SP (Inominal / Heavy overload)	
											LS	CT
17	320	12.6	332	475	44	0.89	76	590	620	160M0602	SP 33T (46A)	SP 3403 (46A)
18	340	13.3	350	480	44	0.88	77		680			
19	360	14.1	380	485	45	0.88	78		730			
21	380	14.9	400	495	45	0.88	79		750			
22	400	15.7	425	495	45	0.88	80		810			
25	440	17.3	470	495	45	0.87	81		950			
27	480	18.8	515	495	45	0.86	83		1100			
24	320	16.8	457	490	59	0.89	80		920			
25	340	17.9	490	490	59	0.88	81	1005				
27	360	18.9	520	490	59	0.88	82	1070				
29	380	20.0	550	490	59	0.88	83	1120				
30	400	21.0	585	490	59	0.87	84	1240				
33	440	23.1	648	490	59	0.87	85	1405				
37	480	25.2	710	490	59	0.86	86	1552				
29	320	20.3	563	490	71	0.88	83	1240				
31	340	21.6	602	490	71	0.87	84	1320				
33	360	22.9	641	490	71	0.87	85	1390				
35	380	24.1	576	490	71	0.87	85	1540				
37	400	25.4	715	490	71	0.87	86	1680				
41	440	27.9	790	490	71	0.86	87	1950				
45	480	30.5	871	490	71	0.86	88	2120				
35	320	24.4	685	490	85	0.86	86	1580				
37	340	25.8	730	490	85	0.86	86	1750				
40	360	27.5	780	490	85	0.86	87	1920				
42	380	29.0	820	490	85	0.86	87	2090				
45	400	30.5	870	490	86	0.86	88	2270				
49	440	33.5	960	490	86	0.85	89	2460				
54	480	36.6	1050	490	86	0.84	89	2870				
43	320	29.6	840	490	103	0.86	88	2100				
46	340	31.5	900	490	103	0.86	88	2270				
49	360	33.3	955	490	103	0.86	89	2480				
52	380	35.1	1010	490	102	0.86	89	2710				
55	400	37.0	1065	490	103	0.86	89	2970				
60	440	40.7	1175	480	101	0.85	90	3170				
62	480	44.4	1290	460	97	0.84	91	3750				
59	320	40.0	1155	490	145	0.81	90	3300				
63	340	42.5	1230	490	145	0.81	91	3450				
67	360	45.0	1305	490	145	0.81	91	3610				
71	380	47.5	1380	490	145	0.81	92	3760				
75	400	50.0	1455	490	145	0.81	92	4060				
81	440	55.0	1605	480	143	0.80	92	4370				
85	480	60.0	1760	460	139	0.79	93	5500				
72	320	49.6	1442	475	167	0.83	92	4050				
76	340	52.7	1535	475	167	0.83	92	4350				
81	360	55.8	1628	475	167	0.83	93	4650				
86	380	58.9	1720	475	167	0.83	93	4940				
90	400	62.0	1810	475	168	0.83	93	5100				
98	440	68.2	2000	465	164	0.82	94	5850				
103	480	74.4	2189	450	160	0.82	94	6600				

\* voltage available on output from the drive

(1): Phase-to-phase resistance value

These indicative values are non-contractual and may be modified at any time by the manufacturer.

**CPLS**  
**Asynchronous motors for variable frequency**  
**Electrical characteristics**  
**Selection tables**

**CPLS 160M / 390 - 490 N.m**

Motor IP23 – Ventilation IC06 – Class F  
 Service S1 – Ambient temperature 40°C – Total mass: 289 kg  
 Inertia: 0.246 kg.m<sup>2</sup> - Maximum mechanical speed: 7,000 min<sup>-1</sup> (10000 min<sup>-1</sup> with HV3 configuration)  
 1.1 kW forced ventilation – 230/400V 50Hz

P (kW)	U (V)*	F(Hz)	n <sub>1</sub> (min <sup>-1</sup> )	T (N.m)	I (A)	cos φ	η (%)	R (Ω) ( <sup>1</sup> )	n <sub>2</sub> (min <sup>-1</sup> )	CPLS	UNIDRIVE SP (Inominal / Heavy overload)		
											SP LS / CT	SPM	SPM Regen
87	320	63.2	1845	450	191	0.88	93	31	4650	160M0609	SP 150T SP 6402  (210A)		
93	340	67.1	1960	450	191	0.88	93		4960				
98	360	71.1	2083	450	190	0.88	94		5250				
104	380	75.1	2204	450	190	0.88	94		5550				
110	400	79.0	2320	450	192	0.88	94		5800				
116	440	86.9	2560	430	183	0.87	94		6500				
122	480	98.0	2890	405	173	0.88	94		7000				
106	320	88.0	2590	390	224	0.90	95		6177				
113	340	93.5	2755	390	224	0.90	95	6567	160M0610	SP 74X1  (238A)	SPMD 14X3-1S (246A)	SPMD 1423-1R (246A)	
119	360	99.0	2920	390	223	0.89	95	7000					
127	380	105	3100	390	223	0.90	95	7000					
132	400	110	3255	390	223	0.89	95	7000					
-	-	-	-	-	-	-	-	-					
-	-	-	-	-	-	-	-	-					

\* voltage available on output from the drive

(<sup>1</sup>): Phase-to-phase resistance value

These indicative values are non-contractual and may be modified at any time by the manufacturer.



**CPLS**  
Asynchronous motors for variable frequency  
Electrical characteristics  
**Selection tables**

**CPLS 160L / 490 - 700 N.m**

Motor IP23 – Ventilation IC06 – Class F  
Service S1 – Ambient temperature 40°C – Total mass: 362 kg  
Inertia: 0.455 kg.m<sup>2</sup> - Maximum mechanical speed: 5,000 min<sup>-1</sup>  
1.1 kW forced ventilation – 230/400V 50Hz

P (kW)	U (V)*	F(Hz)	n <sub>1</sub> (min <sup>-1</sup> )	T (N.m)	I (A)	cos φ	η (%)	R (Ω) (1)	n <sub>2</sub> (min <sup>-1</sup> )	CPLS	UNIDRIVE SP (Inominal / Heavy overload)	
											LS	CT
24	320	11.7	320	702	60	0.91	78	540	500	160L0603	SP 40T (60A)	SP 4401 (60A)
25	340	12.4	341	702	60	0.90	79					
27	360	13.1	363	700	59	0.90	80					
28	380	13.9	387	700	59	0.90	81					
30	400	14.6	409	700	59	0.89	82					
33	440	16.1	454	698	59	0.88	83					
36	480	17.5	496	698	59	0.88	84					
29	320	14.2	395	700	71	0.90	81					
31	340	15.1	422	700	71	0.90	82					
33	360	16.0	450	700	71	0.90	83					
35	380	16.9	477	700	71	0.89	83					
37	400	17.8	504	700	71	0.89	84					
41	440	19.6	558	700	71	0.89	85					
45	480	21.4	613	700	71	0.88	86					
36	320	17.1	485	698	85	0.90	84					
38	340	18.2	516	700	85	0.89	85					
40	360	19.3	549	700	85	0.89	85					
43	380	20.3	580	700	85	0.89	86					
45	400	21.4	613	700	85	0.88	87					
50	440	23.5	676	700	85	0.88	87					
54	480	25.7	743	694	84	0.88	88					
44	320	20.8	595	700	103	0.88	86					
47	340	22.1	634	700	102	0.88	87					
49	360	23.4	673	700	102	0.88	88					
52	380	24.7	712	700	102	0.88	88					
55	400	26.0	751	699	102	0.88	88					
60	440	28.6	830	685	100	0.87	89					
64	480	31.2	909	672	99	0.86	90					
60	320	29.2	844	679	139	0.87	89					
64	340	31.0	898	676	139	0.87	90					
68	360	32.9	955	676	138	0.86	90					
71	380	34.7	1010	675	138	0.86	90					
75	400	36.5	1064	673	138	0.86	91					
81	440	40.2	1175	661	136	0.85	92					
88	480	43.8	1284	654	134	0.85	92					
72	320	36.1	1053	650	165	0.86	91					
76	340	38.3	1119	650	165	0.85	92					
81	360	40.6	1188	650	165	0.86	92					
85	380	42.8	1254	650	165	0.85	92					
90	400	45.1	1323	649	164	0.85	92					
97	440	49.6	1459	635	161	0.85	93					
104	480	54.1	1595	623	159	0.84	93					
88	320	45.6	1338	625	197	0.86	93					
93	340	48.5	1425	625	197	0.86	93					
99	360	51.3	1509	625	197	0.86	93					
105	380	54.2	1596	625	197	0.86	93					
110	400	57.0	1680	625	197	0.86	93					
117	440	62.7	1853	603	191	0.85	94					
125	480	68.4	2025	590	188	0.85	94					

\* voltage available on output from the drive

(1): Phase-to-phase resistance value

These indicative values are non-contractual and may be modified at any time by the manufacturer.

# CPLS

## Asynchronous motors for variable frequency

### Electrical characteristics

### Selection tables

## CPLS 160L / 490 - 700 N.m

Motor IP23 – Ventilation IC06 – Class F  
 Service S1 – Ambient temperature 40°C – Total mass: 362 kg  
 Inertia: 0.455 kg.m<sup>2</sup> - Maximum mechanical speed: 5,000 min<sup>-1</sup>  
 1.1 kW forced ventilation – 230/400V 50Hz

P (kW)	U (V)*	F(Hz)	n <sub>1</sub> (min <sup>-1</sup> )	T (N.m)	I (A)	cos φ	η (%)	R (Ω) (1)	n <sub>2</sub> (min <sup>-1</sup> )	CPLS	UNIDRIVE SP (Inominal / Heavy overload)		
											SP	SPM	SPM Regen
110	320	59.2	1741	603	233	0.91	93	27	3700	160L0610	SP 74X1 (238A)	SPMD 14X3-1S (246A)	SPMD 1423-1R (246A)
116	340	62.9	1852	596	230	0.90	94		4000				
121	360	66.6	1964	591	228	0.90	94		4300				
126	380	70.3	2075	582	225	0.90	94		4600				
132	400	74.0	2187	577	223	0.90	94		5000				
139	440	81.4	2411	551	213	0.90	95		5000				
148	480	88.8	2634	537	208	0.90	95		5000				
138	320	84.8	2506	526	285	0.92	94		5000				
144	340	90.1	2666	516	280	0.92	95	5000	160L0611	SP 74X2 (290A)	SPMD 14X4-1S (290A)	SPMD 1424-1R (290A)	
150	360	95.4	2826	507	275	0.92	95	5000					
155	380	100.7	2986	496	268	0.92	95	5000					
160	400	106.0	3146	486	263	0.91	95	5000					
166	440	116.6	3466	458	248	0.91	96	5000					
171	480	127.2	3786	432	234	0.91	96	5000					

\* voltage available on output from the drive

(1): Phase-to-phase resistance value

These indicative values are non-contractual and may be modified at any time by the manufacturer.

**CPLS**  
**Asynchronous motors for variable frequency**  
**Electrical characteristics**  
**Selection tables**

**CPLS 200S / 680 - 940 N.m**

Motor IP23 – Ventilation IC06 – Class F  
 Service S1 – Ambient temperature 40°C – Total mass: 505 kg  
 Inertia: 0.700 kg.m<sup>2</sup> - Maximum mechanical speed: 5000 min<sup>-1</sup> (10000 min<sup>-1</sup> with HV3 configuration)  
 2.2 kW forced ventilation – 230/400V 50Hz

P (kW)	U (V)*	F(Hz)	n <sub>1</sub> (min <sup>-1</sup> )	T (N.m)	I (A)	cos φ	η (%)	R (Ω) ( <sup>1</sup> )	n <sub>2</sub> (min <sup>-1</sup> )	CPLS	UNIDRIVE SP (Inominal / Heavy overload)			
											SP LS / CT	SPM	SPM Regen	
35	320	14.0	376	883	91.0	0.88	78.2	278	560	200S0604	SP 60T SP 4403  (96A)			
38	340	14.9	403	887	91.3	0.88	79.3							605
40	360	15.8	431	886	91.0	0.88	80.4							676
43	380	16.6	455	891	91.0	0.87	81.3							735
45	400	17.5	482	890	90.7	0.87	82.2							846
51	440	19.3	536	898	91.3	0.87	83.6							909
56	480	21.0	588	900	91.1	0.86	84.8							1060
43	320	16.0	440	937	113	0.85	81.3							187.8
46	340	17.0	470	940	113	0.85	82.3	878						
50	360	18.0	500	944	113	0.85	83.1	950						
52	380	19.0	531	940	113	0.84	83.9	1051						
55	400	20.0	561	935	112	0.84	84.7	1165						
61	440	22.0	622	935	112	0.83	85.9	1261						
67	480	24.0	682	937	112	0.83	86.9	1355						
59	320	22.3	628	903	146	0.86	85.6	108.4	1171	200S0606	SP 100T SP 5402  (156A)			
63	340	23.7	670	900	145	0.86	86.4							1290
67	360	25.1	712	900	145	0.86	87.0							1351
71	380	26.5	755	900	145	0.85	87.6							1441
75	400	27.9	796	900	144	0.85	88.2							1587
83	440	30.7	881	893	143	0.85	89.1							1700
90	480	33.5	966	890	143	0.85	89.9							1865
72	320	27.0	767	890	172	0.86	87.6							77
77	340	28.7	820	890	172	0.86	88.2	1614						
81	360	30.4	871	887	171	0.86	88.8	1734						
86	380	32.1	922	884	170	0.85	89.3	1826						
90	400	33.8	974	882	170	0.85	89.7	1974						
99	440	37.2	1076	875	168	0.85	90.6	2186						
108	480	40.6	1180	870	167	0.85	91.2	2369						
89	320	33.2	956	883	209	0.85	89.6	49.8	1917	200S0608	SP 150T SP 6402  (210A)			
94	340	35.3	1019	880	208	0.85	90.1							2100
100	360	37.4	1083	877	208	0.85	90.6							2300
104	380	39.4	1143	877	207	0.85	91.0							2460
110	400	41.5	1200	875	206	0.84	91.4							2600
121	440	45.7	1338	866	205	0.84	91.8							2758
131	480	49.8	1457	858	202	0.84	92.5							2944
105	320	40.4	1170	858	247	0.84	91.1							36.4
112	340	42.9	1246	858	247	0.84	91.6	2600						
119	360	45.5	1324	856	246	0.84	91.9	2775						
125	380	48.0	1400	855	246	0.84	92.3	2930						
132	400	50.5	1474	855	245	0.84	92.6	3080						
146	440	55.6	1627	853	245	0.84	93.1	3380						
158	480	60.6	1778	848	244	0.83	93.6	3568						
128	320	49.6	1446	845	295	0.85	92.5	25	2930	200S0610	SP 84X1  (335A)	SPMA 14X1-2S (342A)	SPMD 1421-2R (342A)	
136	340	52.7	1540	843	295	0.84	92.8							3125
144	360	55.8	1633	841	294	0.84	93.1							3320
152	380	58.9	1726	840	293	0.84	93.4							3450
160	400	62.0	1816	840	293	0.84	93.7							3712
174	440	68.2	2005	830	289	0.84	94.1							4100
188	480	74.4	2192	820	286	0.84	94.5							4467

\* voltage available on output from the drive

(1): Phase-to-phase resistance value

These indicative values are non-contractual and may be modified at any time by the manufacturer.

# CPLS

## Asynchronous motors for variable frequency

### Electrical characteristics

### Selection tables

## CPLS 200S / 680 - 940 N.m

Motor IP23 – Ventilation IC06 – Class F

Service S1 – Ambient temperature 40°C – Total mass: 505 kg

Inertia: 0.700 kg.m<sup>2</sup> - Maximum mechanical speed: 5000 min<sup>-1</sup> (10000 min<sup>-1</sup> with HV3 configuration)

2.2 kW forced ventilation – 230/400V 50Hz

P (kW)	U (V)*	F(Hz)	n <sub>1</sub> (min <sup>-1</sup> )	T (N.m)	I (A)	cos φ	η (%)	R (Ω) ( <sup>1</sup> )	n <sub>2</sub> (min <sup>-1</sup> )	CPLS	UNIDRIVE SP (Inominal / Heavy overload)		
											SP	SPM	SPM Regen
160	320	68,0	2000	760	358	0.86	93.7	16.3	3800	200S0611	SP 84X2 (389A)	SPMA 14X2-2S (400A)	SPMD 1422-2R (400A)
170	340	72,3	2125	760	357	0.86	93.9		4030				
180	360	76,5	2254	760	357	0.86	94.2		4257				
190	380	80,8	2383	760	357	0.86	94.4		4500				
200	400	85,0	2510	760	357	0.86	94.6		4750				
213	440	93,5	2764	736	345	0.85	94.9		5000				
228	480	102,0	3020	721	339	0.85	95.2		5000				
205	320	94,4	2790	702	451	0.87	94.9		5000				
216	340	100,3	2967	696	447	0.86	95.1	5000	200S0612	SP 84X3 (450A)	SPMD 14X3-2L (468A)	SPMD 1423-2R (468A)	
227	360	106,2	3145	688	442	0.86	95.3	5000					
238	380	112,1	3322	685	440	0.86	95.4	5000					
250	400	118,0	3500	683	438	0.86	95.5	5000					
-	440	-	-	-	-	-	-	-					
-	480	-	-	-	-	-	-	-					

\* voltage available on output from the drive

(<sup>1</sup>): Phase-to-phase resistance value

These indicative values are non-contractual and may be modified at any time by the manufacturer.

**CPLS**  
Asynchronous motors for variable frequency  
Electrical characteristics  
**Selection tables**

**CPLS 200M / 900 - 1300 N.m**

Motor IP23 – Ventilation IC06 – Class F

Service S1 – Ambient temperature 40°C – Total mass: 615 kg

Inertia: 0.98 kg.m<sup>2</sup> - Maximum mechanical speed: 5000 min<sup>-1</sup> (10000 min<sup>-1</sup> with HV3 configuration)

2.2 kW forced ventilation – 230/400V 50Hz

P (kW)	U (V)*	F(Hz)	n <sub>1</sub> (min <sup>-1</sup> )	T (N.m)	I (A)	cos φ	η (%)	R (Ω) ( <sup>1</sup> )	n <sub>2</sub> (min <sup>-1</sup> )	CPLS	UNIDRIVE SP (Inominal / Heavy overload)			
											SP LS / CT	SPM	SPM Regen	
43	320	11.7	315	1296	115	0.86	78.7	220.4	534	200M0603	SP 75T SP 5401 (124A)			
46	340	12.4	337	1300	116	0.85	79.3							590
49	360	13.1	358	1300	115	0.85	80.4							650
52	380	13.9	382	1300	115	0.84	82.2							766
55	400	14.6	404	1300	115	0.84	82.2							766
61	440	16.1	450	1300	115	0.84	83.6							897
67	480	17.5	491	1305	115	0.83	84.8							1028
59	320	16.2	449	1255	148	0.86	83.0							821
63	340	17.2	479	1260	148	0.86	83.4	895						
67	360	18.2	509	1260	148	0.86	84.7	967						
71	380	19.2	540	1260	148	0.86	85.5	1056						
75	400	20.2	568	1260	147	0.85	86.1	1115						
83	440	22.2	630	1254	147	0.85	87.3	1240						
91	480	24.2	691	1254	146	0.85	88.2	1374						
71	320	19.6	552	1230	174	0.86	85.8	1058						
77	340	20.8	589	1230	173	0.86	86.5	1148						
81	360	22.1	630	1228	173	0.86	87.2	1250						
86	380	23.3	663	1228	173	0.85	87.8	1326						
90	400	24.5	700	1228	173	0.85	88.3	1390						
99	440	27.0	775	1228	172	0.85	89.2	1540						
108	480	29.4	847	1228	172	0.85	89.9	1770						
88	320	24.0	683	1225	209	0.86	87.8	1340						
93	340	25.5	728	1222	209	0.86	88.5	1445						
99	360	27.0	774	1221	208	0.86	89.1	1535						
105	380	28.5	819	1217	207	0.85	89.6	1626						
110	400	30.0	864	1215	207	0.85	90.0	1717						
122	440	33.0	954	1215	206	0.85	90.8	1900						
133	480	36.0	1045	1215	206	0.85	91.4	2080						
105	320	28.6	823	1222	251	0.85	89.7	1562						
112	340	30.3	875	1222	250	0.84	90.2	1632						
119	360	32.1	929	1220	250	0.84	90.6	1820						
125	380	33.9	983	1217	249	0.84	91.1	1963						
132	400	35.7	1037	1214	248	0.84	91.4	2090						
146	440	39.3	1145	1212	248	0.84	92.0	2320						
159	480	42.8	1252	1212	248	0.83	92.7	2560						
128	320	36.0	1041	1173	297	0.85	91.2	2012						
136	340	38.3	1110	1168	295	0.85	91.5	2148						
144	360	40.5	1177	1168	295	0.85	91.9	2311						
152	380	42.8	1246	1164	294	0.85	92.3	2475						
160	400	45.0	1312	1164	293	0.85	92.6	2640						
176	440	49.5	1448	1157	291	0.85	93.2	2825						
192	480	54.0	158	1145	288	0.85	93.7	3040						
160	320	46.3	1355	1127	375	0.83	93.0	3087						
170	340	49.2	1442	1125	375	0.83	93.3	3354						
180	360	52.2	1532	1120	374	0.83	93.6	3593						
190	380	55.1	1620	1120	373	0.83	93.9	3803						
200	400	58.0	1706	1119	373	0.82	94.1	4042						
217	440	63.7	1878	1104	368	0.82	94.5	4494						
234	480	69.5	2053	1090	363	0.82	94.8	5000						

\* voltage available on output from the drive

(1): Phase-to-phase resistance value

These indicative values are non-contractual and may be modified at any time by the manufacturer.

# CPLS

## Asynchronous motors for variable frequency

### Electrical characteristics

### Selection tables

## CPLS 200M / 900 - 1300 N.m

Motor IP23 – Ventilation IC06 – Class F

Service S1 – Ambient temperature 40°C – Total mass: 615 kg

Inertia: 0.98 kg.m<sup>2</sup> - Maximum mechanical speed: 5000 min<sup>-1</sup> (10000 min<sup>-1</sup> with HV3 configuration)

2.2 kW forced ventilation – 230/400V 50Hz

P (kW)	U (V)*	F(Hz)	n <sub>1</sub> (min <sup>-1</sup> )	T (N.m)	I (A)	cos φ	η (%)	R (Ω) ( <sup>1</sup> )	n <sub>2</sub> (min <sup>-1</sup> )	CPLS	UNIDRIVE SP (Inominal / Heavy overload)			
											SP	SPM	SPM Regen	
204	320	61.0	1794	1086	461	0.85	93.9	12.1	3604	200M0610	SP 84X4 (545A)	SPMD 14X3-2L (468A)	SPMD 1423-2R (468A)	
217	340	64.9	1910	1082	460	0.85	94.1		3920					
227	360	68.7	2026	1068	454	0.85	94.4		4115					
238	380	72.5	2140	1061	451	0.85	94.6		4298					
250	400	76.3	2260	1057	450	0.85	94.8		4450					
275	440	83.9	2483	1032	438	0.84	95.2		5000					
300	480	91.6	2715	1010	430	0.84	95.4		5000					
256	320	87.9	2604	939	569	0.85	95.3		5000		200M0611	SP 94X1 (620A)	SPMD 14X2-3S (600A)	SPMD 1422-3R (600A)
272	340	93.4	2768	939	569	0.85	95.5		5000					
287	360	98.9	2933	935	566	0.85	95.6		5000					
300	380	104	3098	925	560	0.85	95.7	5000						
315	400	110	3264	922	559	0.85	95.8	5000						
330	440	121	3596	877	533	0.85	96.0	5000						
350	480	132	3927	852	519	0.84	96.1	5000						

\* voltage available on output from the drive

(<sup>1</sup>): Phase-to-phase resistance value

These indicative values are non-contractual and may be modified at any time by the manufacturer.

**CPLS**  
Asynchronous motors for variable frequency  
Electrical characteristics  
**Selection tables**

**CPLS 200L / 1100 - 1550 N.m**

Motor IP23 – Ventilation IC06 – Class F  
Service S1 – Ambient temperature 40°C – Total mass: 740 kg  
Inertia: 1.579 kg.m<sup>2</sup> - Maximum mechanical speed: 4,500 min<sup>-1</sup>  
2.2 kW forced ventilation – 230/400V 50Hz

P (kW)	U (V)*	F(Hz)	n <sub>1</sub> (min <sup>-1</sup> )	T (N.m)	I (A)	cos φ	η (%)	R (Ω) ( <sup>1</sup> )	n <sub>2</sub> (min <sup>-1</sup> )	CPLS	UNIDRIVE SP (Inominal / Heavy overload)		
											SP LS / CT	SPM	SPM Regen
43	320	9.5	267	1537	108	0.88	81.5	248	585	200L0603	SP 75T SP 5401 (124A)		
46	340	10.1	285	1540	108	0.87	82.5		630				
49	360	10.7	305	1540	108	0.87	83.3		688				
52	380	11.3	321	1538	108	0.87	84.1		734				
55	400	11.9	340	1545	109	0.86	84.7		765				
61	440	13.1	376	1536	108	0.86	86.0		855				
66	480	14.3	412	1534	108	0.85	87.0		943				
60	320	13.2	378	1506	143	0.88	85.7		837				
63	340	14.0	402	1505	142	0.88	86.5	897					
67	360	14.9	429	1500	142	0.88	87.1	963					
71	380	15.7	453	1500	142	0.87	87.7	1018					
75	400	16.5	477	1500	141	0.87	88.2	1090					
83	440	18.2	528	1500	141	0.87	89.1	1167					
90	480	19.8	576	1500	141	0.86	89.9	1293					
72	320	15.8	456	1494	169	0.87	87.7	1150					
76	340	16.8	486	1496	169	0.87	88.3	1117					
81	360	17.8	516	1494	169	0.86	88.9	1184					
86	380	18.8	546	1493	169	0.86	89.3	1259					
90	400	19.8	576	1490	169	0.86	89.5	1305					
99	440	21.8	636	1485	168	0.85	90.6	1455					
108	480	23.8	697	1480	167	0.85	91.2	1605					
88	320	19.4	564	1482	204	0.87	89.6	1291					
93	340	20.6	600	1479	203	0.86	90.2	1370					
99	360	21.8	636	1480	203	0.86	90.6	1490					
105	380	23.0	673	1482	203	0.86	91.0	1575					
110	400	24.2	708	1480	203	0.86	91.3	1660					
121	440	26.6	781	1477	203	0.85	91.9	1815					
132	480	29.0	853	1460	201	0.85	92.5	2083					
106	320	23.8	696	1441	236	0.88	91.0	1560					
112	340	25.3	740	1443	237	0.88	91.4	1691					
119	360	26.8	786	1440	236	0.88	91.8	1802					
125	380	28.3	831	1440	236	0.88	92.1	1867					
132	400	29.8	876	1439	236	0.88	92.5	1955					
145	440	32.8	966	1434	235	0.87	92.9	2168					
155	480	35.8	1057	1397	229	0.87	93.5	2474					
128	320	29.6	871	1409	293	0.86	92.5	2185					
136	340	31.5	928	1400	291	0.86	92.9	2315					
144	360	33.3	982	1397	290	0.85	93.2	2442					
152	380	35.2	1040	1396	290	0.85	93.4	2540					
160	400	37.0	1094	1397	290	0.85	93.6	2680					
176	440	40.7	1204	1392	289	0.85	94.0	3010					
192	480	44.4	1316	1350	282	0.84	94.4	3400					
161	320	38.8	1146	1342	359	0.86	93.4	2723					
171	340	41.2	1218	1337	357	0.86	94.1	2890					
181	360	43.7	1293	1334	356	0.86	94.4	3100					
190	380	46.1	1365	1330	355	0.86	94.6	3250					
200	400	48.5	1422	1330	355	0.86	94.8	3450					
218	440	53.4	1584	1314	352	0.86	95.1	3750					
240	480	58.2	1728	1298	348	0.85	85.4	4090					

\* voltage available on output from the drive

(1): Phase-to-phase resistance value

These indicative values are non-contractual and may be modified at any time by the manufacturer.

# CPLS

## Asynchronous motors for variable frequency

### Electrical characteristics

### Selection tables

## CPLS 200L / 1100 - 1550 N.m

Motor IP23 – Ventilation IC06 – Class F  
 Service S1 – Ambient temperature 40°C – Total mass: 740 kg  
 Inertia: 1.579 kg.m<sup>2</sup> - Maximum mechanical speed: 4,500 min<sup>-1</sup>  
 2.2 kW forced ventilation – 230/400V 50Hz

P (kW)	U (V)*	F(Hz)	n <sub>1</sub> (min <sup>-1</sup> )	T (N.m)	I (A)	cos φ	η (%)	R (Ω) ( <sup>1</sup> )	n <sub>2</sub> (min <sup>-1</sup> )	CPLS	UNIDRIVE SP (Inominal / Heavy overload)		
											SP	SPM	SPM Regen
206	320	50.4	1494	1317	454	0.86	94.9	12.6	3608	200L0610	SP 84X4 (545A)	SPMD 14X3-2L (468A)	SPMD 1423-2R (468A)
219	340	53.6	1590	1315	454	0.86	95.1						
226	360	56.7	1683	1293	447	0.86	95.3						
238	380	59.9	1800	1276	441	0.86	95.5						
250	400	63.0	1872	1275	441	0.86	95.5						
272	440	69.3	2062	1260	436	0.85	95.9						
288	480	75.6	2251	1222	424	0.85	96.0						
257	320	68.0	2023	1214	554	0.88	95.5				7	4500	200L0611
268	340	72.3	2152	1216	555	0.88	95.6						
284	360	76.5	2278	1203	549	0.88	95.8						
303	380	80.8	2408	1190	549	0.88	95.9						
315	400	85.0	2533	1187	543	0.87	96.0						
345	440	93.5	2788	1182	540	0.87	96.2						
378	480	102	3043	1170	535	0.87	96.3						
284	320	80.8	2406	1167	627	0.89	95.6	5.53	4500	200L0612			
309	340	85.9	2560	1153	620	0.89	95.7						
324	360	90.9	2710	1142	614	0.88	95.8						
340	380	96.0	2863	1134	610	0.88	95.9						
355	400	101.0	3013	1125	605	0.88	96.0						
391	440	111.1	3313	1095	590	0.88	96.2						
-	-	-	-	-	-	-	-						
-	-	-	-	-	-	-	-						

\* voltage available on output from the drive

(1): Phase-to-phase resistance value

These indicative values are non-contractual and may be modified at any time by the manufacturer.



**CPLS**  
Asynchronous motors for variable frequency  
Electrical characteristics  
**Selection tables**

**CPLS 250S / 1950 - 1570 N.m**

Motor IP23 – Ventilation IC06 – Class F  
Service S1 – Ambient temperature 40°C – Total mass: 1050 kg  
Inertia: 2.65 kg.m<sup>2</sup> - Maximum mechanical speed: 5,000 min<sup>-1</sup>  
3kW forced ventilation – 230/400V 50Hz  
Re-greasable bearings (Insulated NDE as standard)

P (kW)	U (V)*	F(Hz)	n <sub>1</sub> (min <sup>-1</sup> )	T (N.m)	I (A)	cos φ	η (%)	R (Ω) (1)	n <sub>2</sub> (min <sup>-1</sup> )	CPLS	UNIDRIVE SP (Inominal / Heavy overload)			
											SP LS / CT	SPM	SPM Regen	
58	320	10.6	297	1862	144	0.88	82.0	136	665	250S0603	SP 100T SP 5402 (156A)			
62	340	11.2	316	1875	144	0.88	82.9							725
66	360	11.8	334	1886	144	0.87	83.7							770
71	380	12.7	360	1880	144	0.88	84.5							788
75	400	13.4	381	1876	144	0.88	85.2							847
83	440	14.7	421	1880	144	0.87	86.4							993
91	480	16.0	460	1888	144	0.87	87.3							1111
71	320	12.3	348	1947	174	0.88	84.0	99.8	757	250S0604	SP 120T SP 6401 (180A)			
76	340	13.1	372	1950	174	0.87	84.8							844
81	360	13.9	396	1951	174	0.87	85.5							903
86	380	14.7	420	1953	174	0.87	86.2							963
90	400	15.3	439	1957	174	0.86	86.8							1050
100	440	16.9	486	1961	174	0.86	87.8							1200
110	480	18.5	535	1963	174	0.86	88.6							1292
86	320	14.6	418	1965	204	0.86	86.2	69.6	1020	250S0605	SP 150T SP 6402 (210A)			
92	340	15.6	448	1961	209	0.86	87.0							1080
98	360	16.5	475	1970	209	0.86	87.6							1142
104	380	17.5	505	1966	209	0.86	88.1							1203
110	400	18.4	531	1973	209	0.86	88.6							1292
122	440	20.4	592	1968	208	0.86	89.5							1413
134	480	22.4	652	1963	208	0.86	90.2							1590
104	320	17.6	507	1957	245	0.87	88.1	49.8	1173	250S0606	SP 74X2 (290A)	SPMD 14X3-1S (246A)	SPMD 1423-1R (246A)	
111	340	18.7	540	1961	245	0.87	88.7							1263
118	360	19.8	574	1964	245	0.87	89.2							1352
125	380	20.9	606	1967	245	0.86	89.7							1442
132	400	22.0	640	1970	245	0.86	90.1							1530
145	440	24.1	703	1969	245	0.86	90.8							1740
159	480	26.5	775	1958	244	0.86	91.5							1920
127	320	22.1	642	1887	289	0.88	90.1	33.8	1440	250S0607	SP 74X2 (290A)	SPMD 14X4-1S (290A)	SPMD 1424-1R (290A)	
135	340	23.4	681	1891	289	0.88	90.6							1565
144	360	24.9	726	1893	289	0.88	91.0							1645
152	380	26.2	765	1896	289	0.87	91.4							1775
160	400	27.5	805	1898	289	0.87	91.7							1907
177	440	30.3	889	1901	289	0.87	92.3							2074
193	480	33.1	973	1894	288	0.87	92.8							2340
147	320	25.6	748	1876	334	0.87	91.2	25.0	1773	250S0608	SP 84X1 (335A)	SPMD 14X1-2L (342A)	SPMD 1421-2R (342A)	
157	340	27.3	799	1876	334	0.87	91.7							1893
167	360	28.9	847	1883	334	0.87	92.0							2024
176	380	30.4	892	1883	334	0.87	92.3							2185
185	400	31.9	937	1885	334	0.86	92.6							2311
204	440	35.5	1045	1864	331	0.87	93.1							2580
223	480	39.6	1168	1825	327	0.88	93.6							2646
180	320	31.5	925	1859	399	0.88	92.5	17.4	2058	250S0609	SP 84X3 (450A)	SPMA 14X2-2S (400A)	SPMA 1422-2R (400A)	
192	340	33.6	987	1857	399	0.88	92.8							2185
203	360	35.4	1040	1861	399	0.88	93.1							2375
212	380	37.3	1099	1844	395	0.87	93.3							2525
225	400	40.2	1185	1814	393	0.88	93.6							2580
244	440	44.8	1323	1762	384	0.89	94.1							2830
262	480	49.8	1473	1700	375	0.89	94.5							2980

\* voltage available at the output from the drive

(1): Phase-to-phase resistance value

These indicative values are non-contractual and may be modified at any time by the manufacturer.

# CPLS

## Asynchronous motors for variable frequency

### Electrical characteristics

### Selection tables

## CPLS 250S / 1950 - 1570 N.m

Motor IP23 – Ventilation IC06 – Class F  
 Service S1 – Ambient temperature 40°C – Total mass: 1050 kg  
 Inertia: 2.65 kg.m<sup>2</sup> - Maximum mechanical speed: 5,000 min<sup>-1</sup>  
 3kW forced ventilation – 230/400V 50Hz  
 Re-greasable bearings (Insulated NDE as standard)

P (kW)	U (V)*	F(Hz)	n <sub>1</sub> (min <sup>-1</sup> )	T (N.m)	I (A)	cos φ	η (%)	R (Ω) (1)	n <sub>2</sub> (min <sup>-1</sup> )	CPLS	UNIDRIVE SP (Inominal / Heavy overload)		
											SP	SPM	SPM Regen
200	320	35.2	1035	1845	449	0.86	93.2	14	2490	250S0610	SP 84X3 (450A)	SPMD 14X3-2L (468A)	SPMD 1423-2R (468A)
214	340	37.7	1110	1842	449	0.86	93.5						
226	360	39.7	1170	1846	449	0.86	93.8						
238	380	41.7	1230	1849	449	0.86	94.0						
250	400	43.7	1290	1850	449	0.85	94.2						
273	440	48.0	1420	1837	446	0.85	94.6						
298	480	55.2	1634	1800	445	0.88	95.0						
258	320	46.2	1365	1806	569	0.87	94.4						
274	340	49.0	1450	1807	569	0.87	94.7	8.4	3182	250S0611	SP 94X1 (620A)	SPMD 14X2-3L (600A)	SPMD 1422-3R (600A)
290	360	52.0	1539	1800	567	0.87	94.9						
303	380	55.5	1644	1761	558	0.87	95.1						
315	400	58.0	1720	1750	553	0.86	95.2						
343	440	66.0	1960	1673	537	0.88	95.6				SP 84X4 (545A)	SPMD 14X4-2L (552A)	SPMD 1424-2R (552A)
360	480	70.0	2080	1653	526	0.86	95.8						
294	320	54.0	1600	1756	647	0.86	95.0						
314	340	58.0	1719	1745	645	0.87	95.2						
325	360	60.7	1801	1724	636	0.86	95.4	6.2	4020	250S0612	SP 94X3 (790A)	SPMD 14X3-3L (702A)	SPMD 1423-3R (702A)
338	380	64.0	1900	1700	627	0.86	95.5						
355	400	68.0	2020	1680	622	0.86	95.7						
388	440	79.2	2355	1575	600	0.88	96.0						
410	480	87.0	2590	1512	580	0.88	96.2				SP 94X1 (620A)	SPMD 14X2-3L	SPMD 1422-3R
360	320	71.0	2111	1630	788	0.86	95.8						
375	340	76.0	2261	1584	770	0.86	96.0						
391	360	80.0	2382	1568	762	0.86	96.1						
409	380	86.0	2562	1525	747	0.87	96.2	3.7	5000	250S0613	SP 94X3 (790A)	SPMD 14X4-3L (828A)	SPMD 1424-3R (828A)
430	400	95.0	2831	1450	728	0.88	96.4						
-	-	-	-	-	-	-	-						
-	-	-	-	-	-	-	-						

\* voltage available at the output from the drive

(1): Phase-to-phase resistance value

These indicative values are non-contractual and may be modified at any time by the manufacturer.

# CPLS

## Asynchronous motors for variable frequency

### Electrical characteristics

### Selection tables

## CPLS 250M / 2360 - 1710 N.m

Motor IP23 – Ventilation IC06 – Class F  
 Service S1 – Ambient temperature 40°C – Total mass: 1200 kg  
 Inertia: 3.14 kg.m<sup>2</sup> - Maximum mechanical speed: 5,000 min<sup>-1</sup>  
 3kW forced ventilation – 230/400V 50Hz  
 Re-greasable bearings (Insulated NDE as standard)

P (kW)	U (V)*	F(Hz)	n <sub>1</sub> (min <sup>-1</sup> )	T (N.m)	I (A)	cos φ	η (%)	R (Ω) (1)	n <sub>2</sub> (min <sup>-1</sup> )	CPLS	UNIDRIVE SP (Inominal / Heavy overload)					
											SP LS / CT	SPM	SPM Regen			
58	320	8.7	241	2298	144	0.90	81.4	142	475	250M0603	SP 100T SP 5402 (156A)					
62	340	9.2	256	2310	143	0.89	82.3									
67	360	9.9	277	2311	144	0.90	83.2									
71	380	10.4	292	2321	144	0.89	84.0									
75	400	11.0	310	2309	143	0.89	84.8									
83	440	12.0	340	2327	143	0.88	85.9									
90	480	12.8	365	2350	143	0.87	86.9									
71	320	10.4	291	2330	170	0.90	83.5									
76	340	11.0	309	2347	171	0.90	84.4									
81	360	11.6	327	2362	171	0.89	85.1									
86	380	12.2	346	2376	171	0.89	85.8									
90	400	12.7	361	2380	170	0.88	86.4									
99	440	13.8	395	2395	170	0.87	87.5									
108	480	14.9	428	2408	170	0.86	88.3									
86	320	12.3	350	2352	203	0.89	86.0									
92	340	13.1	373	2354	203	0.88	86.7									
98	360	13.9	397	2356	203	0.88	87.3									
104	380	14.7	421	2357	203	0.88	87.9									
110	400	15.5	445	2359	203	0.88	88.4									
121	440	17.1	493	2341	201	0.88	89.4									
133	480	18.7	541	2345	202	0.88	90.1									
104	320	15.1	432	2297	237	0.90	88.0									
111	340	16.1	462	2292	237	0.89	88.6									
118	360	17.0	489	2301	237	0.89	89.1									
125	380	18.0	519	2297	237	0.89	89.6									
132	400	18.9	547	2305	237	0.89	90.0									
145	440	20.6	598	2314	236	0.89	90.8									
159	480	22.5	655	2317	236	0.88	91.4									
128	320	18.3	529	2311	288	0.89	89.8									
136	340	19.4	562	2311	287	0.89	90.3									
144	360	20.4	592	2321	287	0.88	90.7									
152	380	21.4	622	2330	287	0.88	91.1									
160	400	22.4	652	2340	287	0.88	91.5									
176	440	24.6	719	2337	286	0.88	92.1									
192	480	27.0	791	2318	284	0.88	92.6									
147	320	20.8	605	2320	332	0.88	91.0									
157	340	22.2	647	2317	332	0.88	91.4									
167	360	23.6	689	2314	331	0.88	91.8									
176	380	24.9	728	2308	330	0.88	92.2									
185	400	26.1	764	2311	330	0.88	92.4									
204	440	28.7	842	2312	330	0.87	93.0									
223	480	31.5	926	2298	328	0.87	93.4									
180	320	25.9	757	2270	395	0.89	92.3									
192	340	27.5	805	2276	396	0.89	92.6									
203	360	29.1	853	2270	394	0.89	93.0									
212	380	30.4	892	2266	392	0.88	93.2									
225	400	32.5	955	2248	391	0.88	93.5									
244	440	35.8	1054	2211	385	0.88	93.9									
260	480	38.2	1127	2204	380	0.87	94.3									
								19.6	2707	250M0609	SP 84X3 (450A)	SPMD 14X2-2L (400A)	SPMD 1422-2R (400A)			
														SP 84X2 (389A)		

\* voltage available at the output from the drive

(1): Phase-to-phase resistance value

These indicative values are non-contractual and may be modified at any time by the manufacturer.

# CPLS

## Asynchronous motors for variable frequency

### Electrical characteristics

### Selection tables

## CPLS 250M / 2360 - 1710 N.m

Motor IP23 – Ventilation IC06 – Class F  
 Service S1 – Ambient temperature 40°C – Total mass: 1200 kg  
 Inertia: 3.14 kg.m<sup>2</sup> - Maximum mechanical speed: 5,000 min<sup>-1</sup>  
 3kW forced ventilation – 230/400V 50Hz  
 Re-greasable bearings (Insulated NDE as standard)

P (kW)	U (V)*	F(Hz)	n <sub>1</sub> (min <sup>-1</sup> )	T (N.m)	I (A)	cos φ	η (%)	R (Ω) ( <sup>1</sup> )	n <sub>2</sub> (min <sup>-1</sup> )	CPLS	UNIDRIVE SP (Inominal / Heavy overload)			
											SP	SPM	SPM Regen	
200	320	29.1	853	2238	442	0.88	93.1	15.6	1898	250M06010	SP 84X3 (450A)	SPMD 14X3-2L (468A)	SPMD 1423-2R (468A)	
214	340	31.1	913	2237	443	0.88	93.4							2016
226	360	32.7	961	2245	443	0.87	93.7							2195
238	380	34.4	1012	2245	442	0.87	93.9							2359
250	400	36.0	1060	2252	442	0.87	94.1							2522
273	440	39.6	1168	2233	438	0.86	94.6							2816
298	480	43.5	1285	2216	435	0.87	94.9							3122
255	320	36.4	1072	2270	569	0.86	94.2							2657
270	340	38.8	1144	2253	565	0.86	94.5	2880						
283	360	41.0	1211	2233	561	0.86	94.7	3090						
300	380	43.5	1286	2229	561	0.86	94.9	3152						
315	400	46.2	1367	2200	555	0.86	95.1	3422						
345	440	52.5	1556	2120	543	0.87	95.5	3607						
370	480	57.3	1700	2080	533	0.87	95.8	4000						
290	320	42.6	1260	2200	646	0.85	94.9	3300						
309	340	45.2	1337	2208	647	0.85	95.1	3510						
324	360	47.7	1413	2191	643	0.85	95.2	3810						
338	380	50.5	1497	2157	634	0.85	95.4	4080						
355	400	54.0	1600	2117	626	0.86	95.7	4230						
387	440	60.0	1782	2075	616	0.86	95.9	4623						
420	480	67.0	1992	2015	605	0.85	96.1	4867						
360	320	57.0	1692	2032	787	0.86	95.8	4384						
380	340	60.0	1782	2037	786	0.86	95.9	4802						
400	360	63.0	1873	2040	786	0.85	96.0	5000						
420	380	66.2	1969	2038	784	0.85	96.2	5000						
450	400	72.3	2150	2000	778	0.87	96.3	5000						
480	440	80.8	2406	1905	750	0.87	96.5	5000						
500	480	90.0	2682	1781	711	0.87	96.6	5000						
434	320	81.6	2424	1711	890	0.92	96.3	3200						
461	340	86.7	2577	1710	889	0.91	96.4	3536						
480	360	90.0	2677	1713	874	0.91	96.5	3865						
510	380	98.7	2937	1659	876	0.92	96.6	3860						
520	400	103	3067	1620	849	0.92	96.7	4286						

\* voltage available at the output from the drive

(<sup>1</sup>): Phase-to-phase resistance value

These indicative values are non-contractual and may be modified at any time by the manufacturer.

**CPLS**  
Asynchronous motors for variable frequency  
Electrical characteristics  
**Selection tables**

**CPLS 250L / 2900 - 2300 N.m**

Motor IP23 – Ventilation IC06 – Class F  
Service S1 – Ambient temperature 40°C – Total mass: 1500 kg  
Inertia: 4.92 kg.m<sup>2</sup> - Maximum mechanical speed: 3,800 min<sup>-1</sup>  
3kW forced ventilation – 230/400V 50Hz  
Re-greasable bearings (Insulated NDE as standard)

P (kW)	U (V)*	F(Hz)	n <sub>1</sub> (min <sup>-1</sup> )	T (N.m)	I (A)	cos φ	η (%)	R (Ω) (1)	n <sub>2</sub> (min <sup>-1</sup> )	CPLS	UNIDRIVE SP (Nominal / Heavy overload)		
											SP LS / CT	SPM	SPM Regen
70	320	8.2	233	2873	174	0.88	81.4	132	345	250L0603	SP 120T SP 6401 (180A)		
75	340	8.7	248	2891	174	0.88	82.4						
80	360	9.2	263	2906	174	0.88	83.3						
85	380	9.7	278	2920	174	0.88	84.0						
90	400	10.2	293	2932	174	0.88	84.8						
100	440	11.2	323	2954	174	0.87	86.0						
110	480	12.3	356	2948	174	0.87	87.0						
86	320	9.9	284	2893	209	0.88	84.2						
92	340	10.5	302	2909	209	0.88	85.0						
98	360	11.1	320	2924	209	0.88	85.8						
104	380	11.7	338	2937	209	0.87	86.4						
110	400	12.3	356	2948	209	0.87	87.0						
122	440	13.7	398	2926	209	0.87	88.0						
133	480	14.8	431	2943	208	0.87	88.9						
103	320	11.7	338	2910	245	0.88	86.4						
110	340	12.5	360	2910	245	0.88	87.1						
117	360	13.2	383	2915	245	0.87	87.7						
124	380	14.0	407	2908	245	0.87	88.3						
132	400	14.9	434	2904	245	0.88	88.8						
145	440	16.1	470	2943	245	0.87	89.6						
158	480	17.6	515	2927	243	0.87	90.4						
125	320	14.6	425	2807	289	0.88	88.7						
132	340	15.3	446	2820	289	0.87	89.2						
141	360	16.3	476	2825	289	0.87	89.7						
150	380	17.3	506	2828	289	0.87	90.2						
160	400	18.7	548	2788	289	0.88	90.6						
175	440	19.9	584	2858	289	0.87	91.3						
192	480	21.8	641	2859	289	0.87	91.9						
145	320	16.7	489	2833	334	0.87	90.0						
154	340	17.7	519	2833	334	0.86	90.5						
164	360	18.8	552	2837	334	0.86	90.9						
174	380	19.9	585	2841	334	0.86	91.3						
185	400	21.3	626	2820	334	0.87	91.7						
203	440	23.1	681	2850	334	0.86	92.3						
222	480	25.3	747	2841	334	0.86	92.8						
176	320	20.4	600	2802	400	0.87	91.4						
188	340	21.8	641	2800	400	0.87	91.9						
200	360	23.2	683	2797	400	0.87	92.2						
211	380	24.4	720	2803	400	0.87	92.5						
225	400	26.4	780	2760	400	0.87	92.8						
242	440	27.8	822	2813	396	0.86	93.3						
260	480	30.0	888	2796	391	0.85	93.7						
193	320	22.4	659	2801	450	0.84	96.2						
206	340	23.9	703	2800	450	0.84	92.6						
220	360	25.4	750	2803	450	0.84	92.9						
233	380	26.9	795	2801	450	0.85	96.2						
250	400	29.2	863	2768	450	0.86	93.6						
270	440	31.0	918	2810	450	0.84	94.0						
297	480	34.2	1014	2789	447	0.84	94.4						
								18.6	1315	250L0609	SP 84X3 (450A)	SPMD 14X3-2L (468A)	SPMD 1423-2L (468A)
								23.2	1000	250L0608	SP 84X3 (450A)	SPMD 14X2-2L (400A)	SPMD 1422-2R (400A)
								66.6	538	250L0605	SP 74X2 (290A)	SPMD 14X3-1S (246A)	SPMD 1423-1R (246A)
								93.2	445	250L0604	SP 150T SP 6402 (210A)		
								132	585	250L0603	SP 120T SP 6401 (180A)		
								93.2	483	250L0604	SP 150T SP 6402 (210A)		
								66.6	621	250L0605	SP 74X2 (290A)	SPMD 14X3-1S (246A)	SPMD 1423-1R (246A)
								45.4	750	250L0606	SP 74X2 (290A)	SPMD 1404-1S (290A)	SPMD 1424-1R (290A)
								33.4	817	250L0607	SP 84X1 (335A)	SPMD 14X1-2L (342A)	SPMD 1421-2R (342A)
								23.2	1050	250L0608	SP 84X3 (450A)	SPMD 14X2-2L (400A)	SPMD 1422-2R (400A)
								18.6	1110	250L0609	SP 84X3 (450A)	SPMD 14X3-2L (468A)	SPMD 1423-2L (468A)

\* voltage available at output from the drive

(1): Phase-to-phase resistance value

These indicative values are non-contractual and may be modified at any time by the manufacturer.

# CPLS

## Asynchronous motors for variable frequency

### Electrical characteristics

### Selection tables

## CPLS 250L / 2900 - 2300 N.m

Motor IP23 – Ventilation IC06 – Class F  
 Service S1 – Ambient temperature 40°C – Total mass: 1500 kg  
 Inertia: 4.92 kg.m<sup>2</sup> - Maximum mechanical speed: 3,800 min<sup>-1</sup>  
 3kW forced ventilation – 230/400V 50Hz  
 Re-greasable bearings (Insulated NDE as standard)

P (kW)	U (V)*	F(Hz)	n <sub>1</sub> (min <sup>-1</sup> )	T (N.m)	I (A)	cos φ	η (%)	R (Ω) ( <sup>1</sup> )	n <sub>2</sub> (min <sup>-1</sup> )	CPLS	UNIDRIVE SP (Inominal / Heavy overload)							
											SP	SPM	SPM Regen					
250	320	29.3	867	2755	569	0.85	93.6	11.4	1658	250L0610	SP 94X1 (620A)	SPMA 14X2-3S (600A)	SPMA 1422-3R (600A)					
267	340	31.3	927	2753	569	0.85	93.9							1751				
282	360	33.0	978	2755	569	0.84	94.2							1892				
299	380	35.0	1038	2752	569	0.85	94.4							1982				
315	400	36.9	1095	2750	569	0.85	94.6							2102				
345	440	41.0	1217	2706	562	0.85	95.0							2371				
358	480	42.0	1249	2738	563	0.81	95.2							2966				
294	320	34.0	1008	2786	670	0.84	94.3							2000				
308	340	36.0	1068	2755	661	0.84	94.6	2161	8.4	250L0611	SP 94X3 (790A)	SPMD 14X3-3L (702A)	SPMD 1423-3R (702A)					
325	360	38.3	1137	2730	657	0.84	94.8	2310										
342	380	40.5	1203	2715	653	0.84	95.0	2430										
355	400	41.6	1249	2715	652	0.83	95.2	2700										
393	440	47.0	1399	2684	647	0.84	95.5	2851										
426	480	52.0	1548	2628	637	0.84	95.8	3050										
360	320	44.3	1318	2610	819	0.83	95.4	2791						4.9	250L0612	SP 94X4 (900A)	SPMD 14X4-3L (828A)	SPMD 1424-3R (828A)
383	340	47.1	1402	2610	819	0.83	95.5	2971										
407	360	50.0	1489	2611	819	0.83	95.7	3121										
428	380	52.6	1567	2610	819	0.83	95.8	3360										
450	400	55.2	1645	2613	819	0.83	96.0	3570										
490	440	62.3	1837	2520	797	0.84	96.2	3800										
508	480	68.0	2030	2391	761	0.83	96.4	3800										
410	320	50.3	1500	2615	936	0.83	95.7	3270	3.8	250L0613	SP 94X5 (1010A)	SPMD 14X3-4L (937A)	SPMD 1423-4R (937A)					
440	340	55.0	1639	2565	926	0.84	96.0	3272										
465	360	59.5	1773	2500	913	0.85	96.1	3334										
490	380	62.9	1875	2496	911	0.85	96.2	3545										
510	400	67.1	2000	2434	895	0.85	96.4	3665										
540	440	75.2	2245	2300	857	0.86	96.5	3800										
560	480	84.0	2509	2132	807	0.86	96.7	3800										
445	320	61.9	1846	2300	989	0.85	96.2	3724			2.8	250L0614	SP 94X5 (1010A)	SPMD 14X4-4L (1104A)	SPMD 1424-4R (1104A)			
476	340	66.3	1978	2300	989	0.85	96.3	3800										
503	360	70.0	2089	2300	989	0.85	96.4	3800										
532	380	74.0	2209	2300	989	0.85	96.5	3800										
560	400	81.0	2419	2212	973	0.86	96.6	3800										

\* voltage available at output from the drive

(1): Phase-to-phase resistance value

These indicative values are non-contractual and can be modified at any time by the manufacturer.

**Encoder**

**INCREMENTAL ENCODER**

This pulse generator supplies a pulse frequency proportional to the motor speed. Of a traversing hollow shaft type, with two channels at the output + Top = + complements, it may be supplied in a voltage range 5 V ±10% or 11-30 V regulated.

For connections longer than 20 m, cables will be twisted pairs. The maximum length of (screened) cables should not exceed 150 m at the opto-coupler input.

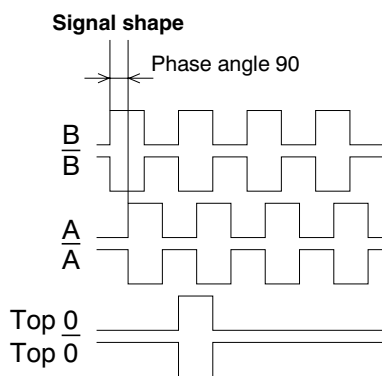

**SINGLE-TURN ABSOLUTE ENCODER**

The single-turn absolute encoder converts the rotation of the drive shaft into a series of "encoded electrical steps". The number of steps per revolution is determined by an optical disk. In general, one shaft rotation consists of 8,192 steps, which corresponds to 13 bits. At the end of a complete encoder shaft revolution, the same values are repeated.



**MULTI-TURN ABSOLUTE ENCODER**

The multi-turn absolute encoder saves the position in the revolution and also over several revolutions, with a maximum of 4096 revolutions.



	Incremental encoders			Absolute encoders		Strengthened Patay incremental encoder	
	TTL	HTL	~ 1 Vpp	Single-turn	Multi-turn	TTL	HTL
<b>Output signals</b>				~ 1 Vpp			
<b>Number of points per turn</b>	1024 std / 10,000 max		1024 std / 5,000 max	8192 std (13 bits)		1024	1024
<b>Number of absolute rotations</b>	-			-	4096 max (12 bits)	-	
<b>Data interface</b>				SSI / EnDat® / Hiperface® / Profibus® / CanOpen			
<b>Supply voltage</b>	5 Vdc ±10%	11-30 Vdc	5 Vdc ±10%	According to data interface		5 Vdc ±10%	11-30 Vdc
<b>Coupling</b>	14 mm traversing hollow shaft						
<b>Protection</b>	IP 65 minimum						
<b>Continuous maximum speed</b>	6,000 rpm as standard Option 10,000 rpm with 12 mm hollow shaft					6,000 rpm	6,000 rpm
<b>Temperature range for use</b>	-20°C to +100°C					-30°C to +120°C	-30°C to +100°C

## Encoder

### ENCODER CONNECTION

The use of incremental encoders in industrial environments comprising high current installations or control by electronic drives, requires industry standard, well-known basic rules to be followed.

#### Basic rules

**1** - Use screened cables. For connections longer than 20 metres, use cables with several screened twisted pairs, reinforced with an overall outer screen. The conductors in a single part are reserved for the channel and its complement: example A and  $\bar{A}$ , B and  $\bar{B}$  etc.

It is recommended that conductors with a minimum standard 0.14mm<sup>2</sup> are used (recommended cable types: LIYCY 0.14 mm<sup>2</sup>).

**2** - Keep the encoder connection cables as far away as possible from the power cables and avoid parallel routing.

**3** - Distribute and connect the 0V and the screens in "star".

**4** - Earth the screens using minimum 4 mm<sup>2</sup> section cables.

**5** - Under no circumstances connect a screen to earth at both ends. Preferably, earth a screened cable on the "user" side from the encoder signals (cabinet, PLC, meter). On the armature side, the screen must be connected to a single point, itself connected to earth generally in conformity with safety standards. On the encoder side, each screen must be perfectly isolated, both in relation to all other screens and in relation to earth or any potential.

Ensure the continuity of the screen when using connectors or connection boxes.

### Precautions when making connections

**1** - Under no circumstances make the connection or disconnection on the encoder side or cabinet side without first cutting the supply.

**2** - For the supply, used stabilised, regulated and filtered, power supplies. Providing supply via transformers delivering an effective 5V (or 24V) at their secondary, followed by filtering rectifiers and capacitors, is prohibited, since, in reality, the continuous voltages obtained thus are:

- for the 5 V:  $5\sqrt{2} = 7.07$  V
- for the 24 V:  $24\sqrt{2} = 33.936$  V

**3** - Comply with the international standards in force.

Incremental encoders (standard Leroy-Somer wiring)												
12 pins	1	2	3	4	5	6	7	8	9	10	11	12
M23 connector	-	+	A	B	O	$\bar{A}$	B	$\bar{O}$		$\frac{\perp}{\perp}$	$\frac{\perp}{\perp}$	$\frac{\perp}{\perp}$
Screened cable	White	Brown	Green	Yellow	Grey	Pink	Blue	Red		Braid	Braid	Braid

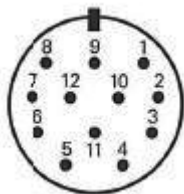

Male connector on the incremental encoder side



# CPLS

## Asynchronous motors for variable frequency

### Optional equipment

#### Insulated bearings

The use of variable speed drives with switching (PWM) can result in premature wear of the bearings.

This phenomenon is explained first of all by the presence of a shaft voltage in relation to earth: the latter, inherent in any asynchronous motor, is due to the lack of symmetry of the rotor in the rotating magnetic field and generates a circulating current in the rotor, looping via the stator through the end shields and bearings. This current can produce electrical discharges between balls and rings, thus reducing their service life.

A second source of currents may be added to the first: this concerns the high-frequency currents generated by the IGBT bridges at the output from the drive. These currents "try" to go back to their source (the drive) and take the path of least resistance: either via the housing/machine chassis/earth link, if it is correctly made; or through the coupled machine via the motor end shields and bearings in the contrary case.

The CPLS may be equipped with insulated bearings at the back (standard on CPLS 250) and on the front when the coupling on the driven machine is not sufficiently insulating. These bearings are fitted instead of the standard bearings.

#### INSULATED BEARING CHARACTERISTICS:

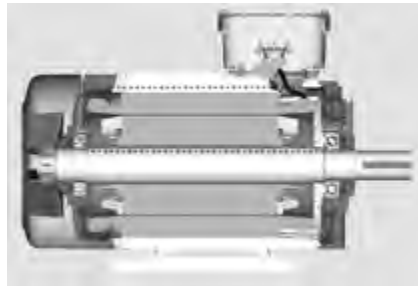

The outer bearing rings are coated with a layer of electrically insulating ceramic.

The dimensions and tolerances of these bearings are identical to the standard ones used and can therefore be fitted instead, with no modifications to the motors. The breakdown voltage is 500 V.

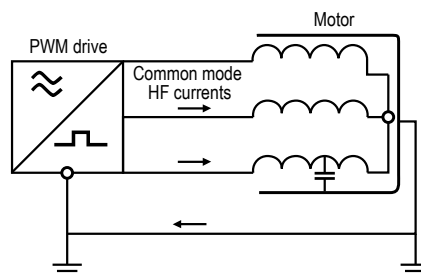

#### EMC CABLE GLANDS

CPLS motors are fitted as standard with pre-drilled and tapped terminal boxes with the holes plugged.

EMC glands with 360° earth connection are available as an option to ensure earth continuity between the cable and the motor in accordance with the EMC directive 89/336/EEC.

# CPLS

## Asynchronous motors for variable frequency

### Optional equipment

### Thermal protection

CPLS motors are equipped with PTC as standard

The motors are protected by the variable speed drive, placed between the isolating switch and the motor.

The drive provides total protection of the motor against overloads.

The motors are fitted with PTC sensors in the winding. As an option, specific thermal protection sensors can be selected from the table below.

**It must be emphasised that sensors cannot be used to carry out direct adjustments to the motor operating cycles.**



### FITTING THERMAL PROTECTION

- PTO or PTF, in the control circuits
- PTC, with relay, in the control circuits
- PT 100 or thermocouples, with reading equipment or recorder, in the installation's control panel for continuous surveillance

### ALARM AND EARLY WARNING

All protective equipment can be backed up by another type of protection (with different NRTs): the first device will then act as an early warning (light or sound signals given without shutting down the power circuits), and the second device will be the alarm (shutting down the power circuits).

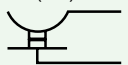
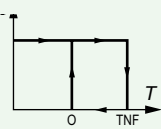
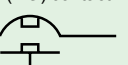
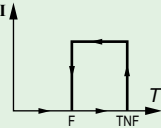
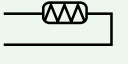
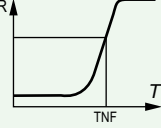
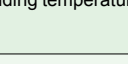
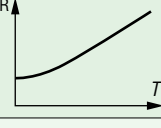
### Built-in indirect thermal protection

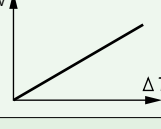
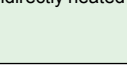
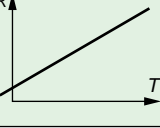
Type	Operating principle	Operating curve	Breaking capacity (A)	Protection provided	Mounting Number of devices*
<b>Normally closed thermal protection PTO</b>	Bimetallic strip, indirectly heated, with normally closed (NC) contact 		2.5 A at 250 V with $\cos \varphi 0.4$	General surveillance for non-transient overloads	Mounted in control circuit 2 or 3 in series
<b>Normally open thermal protection PTF</b>	Bimetallic strip, indirectly heated, with normally open (NO) contact 		2.5 A at 250 V with $\cos \varphi 0.4$	General surveillance for non-transient overloads	Mounted in control circuit 2 or 3 in parallel
<b>Positive temperature coefficient thermistor PTC</b>	Non-linear variable resistor, indirectly heated 		0	General surveillance for transient overloads	Mounted with associated relay in control circuit 3 in series
<b>Temperature sensor KTY</b>	Resistance depends on the winding temperature 		0	High accuracy continuous surveillance of key hot spots	Mounted in control panels with associated reading equipment (or recorder) 1 per hot spot
<b>Thermocouples</b> T (T < 150°C) Constantan Copper K (T < 1000°C) Copper Cupro-nickel	Peltier effect 		0	Continuous surveillance of hot spots at regular intervals	Mounted in control panels with associated reading equipment (or recorder) 1 per hot spot
<b>Platinum temperature sensor PT 100</b>	Linear variable resistor, indirectly heated 		0	High accuracy continuous surveillance of key hot spots	Mounted in control panels with associated reading equipment (or recorder) 1 per hot spot

- NRT: nominal running temperature.

- The NRTs are chosen according to the position of the sensor in the motor and the temperature rise class.

\* The number of devices relates to the winding protection.

# CPLS

## Asynchronous motors for variable frequency

### Optional equipment

#### Ventilation

##### DETECTION OF AIR FLOWS

A pressure switch relay detects when the motor's ventilation shuts down.

This is an air flow monitoring pressure switch; it may therefore provide sufficient protection against reduced air flow (clogged filter, partial obstruction of the air intake or outlet).

Factory adjusted, it's a uni-pole switch rated 1A at 250V. A "Faston" type connector is used.

This detector is fitted on the forced ventilation.



##### "Miovyi" filter

This "long lasting" filter, made of PVC filter elements, provides optimum filtering performance for industrial applications:

- average gravimetric stopping rate of 85%,
- high retention capacity,
- low pressure drop
- can be changed in a few seconds,
- integral and permanent regeneration capability (soaking, rinsing, drying).

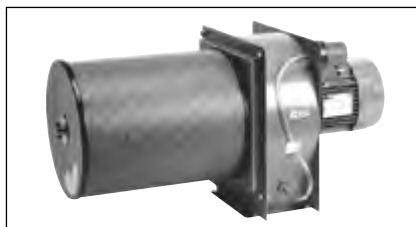

"Miovyi" filter

##### Space requirements for the "Miovyi" filter option

CPLS motor Size	Filter	
	diameter AJ	length RB
CPLS 112	Ø 211	155
CPLS 132	Ø 272	286
CPLS 160	Ø 272	340
CPLS 200/250	request a quotation	

##### Space requirements for forced axial ventilation

CPLS motor Size	Axial forced ventilation		
	AG width	RE	RG
CPLS 112	request a quotation		
CPLS 132	request a quotation		
CPLS 160	318	570	284
CPLS 200	497	678	351
CPLS 250	request a quotation		

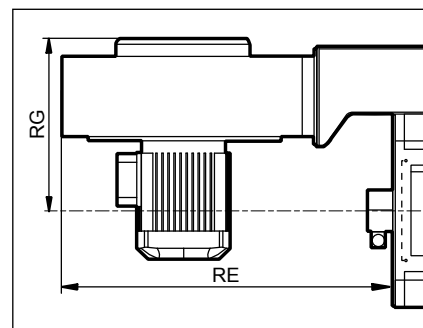

##### AIR FILTER

The forced ventilation unit can be fitted with a suction filter for use in a relatively dusty environment. There are two types of filter available.

##### Standard filter

This filter, made up of polyester filter elements with an average Ashrae 52/76 gravimetric efficiency of 88% is flame retardant (class F1 to DIN 53438).

It may be regenerated by quickly cleaning it (shaking it or blowing compressed air through it) or cleaning it thoroughly (soaking for a few hours in a non-aggressive detergent bath, then rinsing with clean water and drying).

Washing it a maximum of two or three times is recommended.

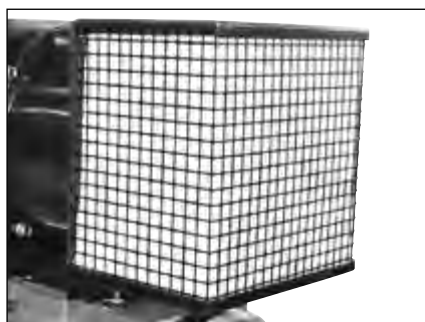

Standard filter

##### AXIAL VENTILATION

In the case where only limited height is available for installation of the motor, a connection kit allows the standard forced ventilation kit to be fitted in an axial position (option not compatible with a brake).



##### EXTERNAL VENTILATION IP55 / IC37

##### Compliance with flow rates

CPLS motor Size	Flow rate m <sup>3</sup> /h	Pressure Pa
CPLS 112	300	600
CPLS 132	550	750
CPLS 160	1200	1500
CPLS 200	2400	1600
CPLS 250	2850	1650

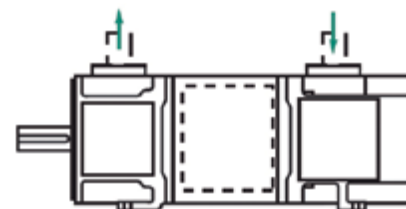

# CPLS

## Asynchronous motors for variable frequency

### Optional equipment

## Heating

---

### HEATING USING ADDITIONAL HEATERS (OPTION)

An environment with high levels of humidity and wide variations in temperature requires space heaters to be used to prevent condensation.

Made of strips insulated with glass fibre on the heads of the coil, they allow the motor's average temperature to be maintained, enabling trouble-free starting and eliminating inconvenience due to condensation (loss of insulation of the machine).

These heaters must be switched on when the machine is shut down and switched off during operation.

The supply wires to the heaters are brought to the motor terminal box.

CPLS motor Size	Number and power (W)
CPLS 112	2 x 25
CPLS 132	2 x 25
CPLS 160	2 x 25
CPLS 200	2 x 50
CPLS 250	4 x 50

Space heaters are supplied with 220/240V, single phase.

### D.C. SUPPLY INJECTION HEATING

An alternative solution to the space heater is supply under reduced ac or dc voltage (10 to 15% of the nominal value) from two phases coupled in series.

This is often sufficient and avoids having to install space heaters.

# CPLS

## Asynchronous motors for variable frequency

### Dimensions

## Terminal boxes and cable glands

Dimensions in millimetres

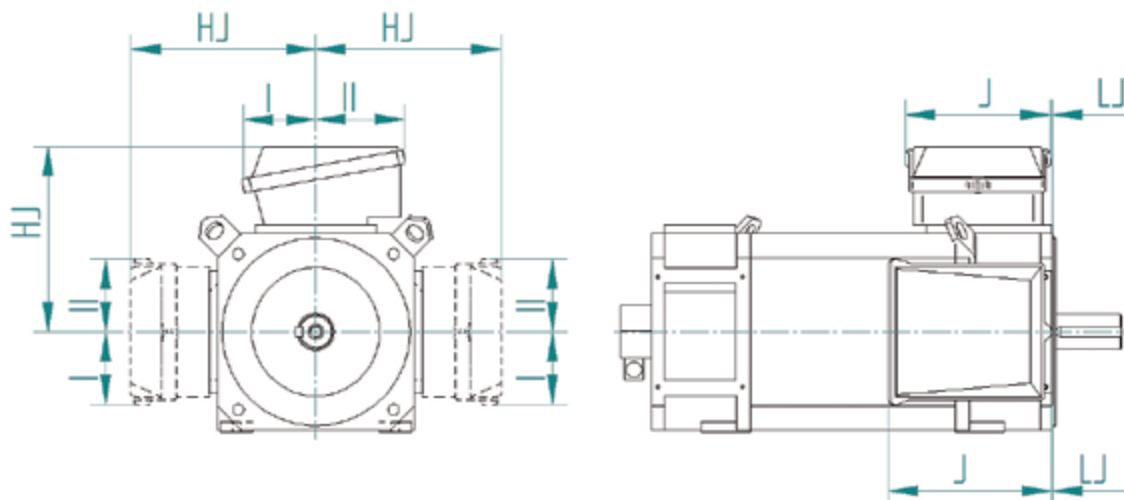

### Terminal box

Depending on the motor's maximum nominal current ( $I_{nom}$ ), there are two types of terminal box fitted on the CPLS range:

Motor type	Standard terminal box ( $I_N \leq I_{LIM}$ )							
	$I_{LIM}$ (A)	Fitting position	I	II	HJ	J	LJ	Terminals
CPLS 112	40	A / B / D	55	55	185	160	2	6 x M6
CPLS 132	74	A / B / D	78.5	78.5	222	194	12.5	6 x M8
CPLS 160	139	A* / B / D	118	142	295	231	4	6 x M10
CPLS 200	139	A / B / D	148	180	371	292	19	6 x M10
CPLS 200	380	A / B / D	148	180	371	292	19	6 x M14
CPLS 250	380	A / B / D	148	180	420.5	292	48	6 x M14

\* not possible for a CPLS 160 S with 60Hz forced ventilation.

Motor type	Large terminal box ( $I_N > I_{LIM}$ )							
	$I_{LIM}$ (A)	Fitting position	I	II	HJ	J	LJ	Terminals
CPLS 112 M / L	40	B / D	63.5	122.5	211	209	0.5	6 x M8
CPLS 132 L	74	A	118	142	397	231	9.5	6 x M8
CPLS 132 S / M / L	74	B / D	80.5	150.5	266	260	7	6 x M8
CPLS 160 L	139	A	148	180	327	292	6	6 x M12
CPLS 160 S / M / L	139	B / D	86	206	330	328	4	6 x M12
CPLS 200 M / L	380	A	180	235	461	420	-45	6 x M16
CPLS 200 S / M / L	380	B / D	150	270	461	415	-15	6 x M16
CPLS 250 S / M / L	380	A / B / D	210	210	510.5	415	-16	6 x M16

### Cable glands

$I_{LIM}$ (A)	$\leq 32$	$\leq 40$	$\leq 74$	$\leq 139$	$\leq 380$	Pour $I_{LIM} > 380$ A, terminal boxes supplied have a removable undrilled, gland support plate.
Size of glands for power	1 x M25	1 x M32	1 x M40	1 x M50	2 x M50	
Size of glands for accessories / options*	M16	M16	M16	M16	M16	

\* the number of cable glands for accessories may vary according to the options chosen.

If your needs are different, please state on the order (within the limit of the terminal box's capacity).

# CPLS

## Asynchronous motors for variable frequency

### Dimensions

### Fixing by feet, feet and flange

Dimensions in millimetres

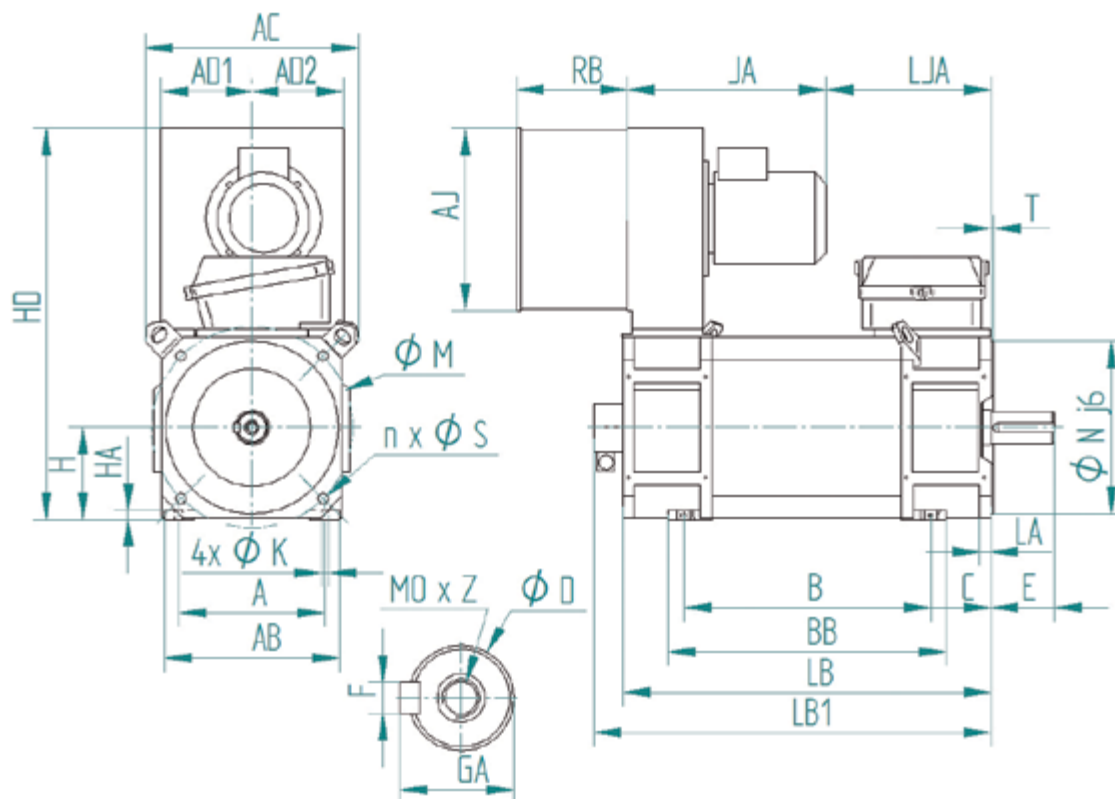

Type	Main dimensions															
	H	HA	HD	A	AB	AC	AD1	AD2	B	BB	LB	LB1	C	JA	LJA	K
CPLS 112 M	112	11	482	190	216	288	110	110	290	338	416	472	70	295	110	12
CPLS 112 L	112	11	482	190	216	288	110	110	330	378	456	512	70	295	150	12
CPLS 132 S	132	11	573	216	254	330	130	130	283	329	444	488	89	310	125	12
CPLS 132 M	132	11	573	216	254	330	130	130	338	384	499	543	89	310	180	12
CPLS 132 L	132	11	573	216	254	330	130	130	418	464	579	623	89	310	260	12
CPLS 160 S	160	16	695	254	305	370	159	159	355	403	563	622	103-108 <sup>(1)</sup>	355 <sup>(2)</sup> / 400 <sup>(3)</sup>	199 <sup>(2)</sup> / 154 <sup>(3)</sup>	14
CPLS 160 M	160	16	680	254	305	370	159	159	435	483	643	702	103-108 <sup>(1)</sup>	355 <sup>(2)</sup> / 400 <sup>(3)</sup>	280 <sup>(2)</sup> / 235 <sup>(3)</sup>	14
CPLS 160 L	160	16	680	254	305	370	159	159	565	613	773	832	103-108 <sup>(1)</sup>	355 <sup>(2)</sup> / 400 <sup>(3)</sup>	410 <sup>(2)</sup> / 365 <sup>(3)</sup>	14
CPLS 200 S	200	18	920	318	390	444	198	299	480	542	755	880	133-137 <sup>(1)</sup>	453	309	18
CPLS 200 M	200	18	920	318	390	444	198	299	610	672	885	1010	133-137 <sup>(1)</sup>	453	439	18
CPLS 200 L	200	18	920	318	390	444	198	299	730	792	1005	1130	133-137 <sup>(1)</sup>	453	559	18
CPLS 250 S	250	20	1040	406	495	571	207	341	618	828	967	1084	168	493 <sup>(2)</sup> / 512 <sup>(3)</sup>	447 <sup>(2)</sup> / 428 <sup>(3)</sup>	22
CPLS 250 M	250	20	1040	406	495	571	207	341	728	938	1077	1194	168	493 <sup>(2)</sup> / 512 <sup>(3)</sup>	557 <sup>(2)</sup> / 538 <sup>(3)</sup>	22
CPLS 250 L	250	20	1040	406	495	571	207	341	908	1118	1257	1374	168	493 <sup>(2)</sup> / 512 <sup>(3)</sup>	737 <sup>(2)</sup> / 718 <sup>(3)</sup>	22

(1) rectangular hole - (2) FV IE2 50Hz - (3) FV IE2 60Hz

Type	Shaft ends						Flanges					
	D	E	F	GA	O	Z	LA	M	Nj6	n	S	T
CPLS 112	38k6	80	10	41	12	28	11	265	230	4	14	4
CPLS 132	48k6	110	14	51.5	16	36	15	300	250	4	18	5
CPLS 160	55m6	110	16	59	20	42	20	350	300	4	18	5
CPLS 200 HV3 <sup>(4)</sup>	65m6	140	18	69	20	42	20	400	350	4	18	5
CPLS 200	80m6	170	22	85	20	42						
CPLS 250 HV2 <sup>(4)</sup>	80m6	170	33	85	20	42						
CPLS 250	100m6	210	28	106	24	50	23	400	350	8	18	5

(4) Incompatible with fitting roller bearings

## Notes

---

**LEROY-SOMER**<sup>™</sup>

[www.leroy-somer.com](http://www.leroy-somer.com)

**Connect with us at:**

[twitter.com/Leroy\\_Somer](https://twitter.com/Leroy_Somer)

[facebook.com/leroy-somer.nidec](https://facebook.com/leroy-somer.nidec)

[youtube.com/user/LeroySomerOfficiel](https://youtube.com/user/LeroySomerOfficiel)

[theautomationengineer.com](http://theautomationengineer.com) (blog)



**Nidec**  
All for dreams

© 2017 Moteurs Leroy-Somer SAS. The information contained in this brochure is for guidance only and does not form part of any contract. The accuracy cannot be guaranteed as Moteurs Leroy-Somer SAS have an ongoing process of development and reserve the right to change the specification of their products without notice.

Moteurs Leroy-Somer SAS. Headquarters: Bd Marcellin Leroy, CS 10015, 16915 Angoulême Cedex 9, France. Share Capital: 65 800 512 €, RCS Angoulême 338 567 258.